

# Fast-tracking the digital revolution: Broadband for Latin America and the Caribbean

Valeria Jordán  
Hernán Galperin  
Wilson Peres  
(Editors)



The preparation of this document was coordinated by Valeria Jordán and Wilson Peres, of the Economic Commission for Latin America and the Caribbean (ECLAC), and Hernán Galperin, from the Regional Dialogue on the Information Society (REDIS), in the framework of the project “Inclusive political dialogue and exchange of experiences”, under the Alliance for the Information Society programme phase 2 (@LIS2), which is jointly financed by ECLAC and the European Union and implemented by the Division of Production, Productivity and Management of ECLAC. The Chief of the Division, Mario Cimoli, brokered the initiative to produce this publication as part of the ongoing quest for excellence.

The coordinators would like to thank Álvaro Calderón, César Cristancho, Francisca Lira, Laura Palacios and Sebastián Vergara, ECLAC staff and consultants, for their support in preparing this publication.

Authors of the chapters (in alphabetical order): Roxana Barrantes (Institute of Peruvian Studies, Lima), Hernán Galperin (San Andrés University, Buenos Aires), Ernesto M. Flores-Roux (Economic Research and Teaching Centre (CIDE), Mexico), Martin Hilbert (ECLAC and Annenberg School of Communication, University of Southern California), Valeria Jordán (ECLAC), Raúl L. Katz (Columbia Business School, Columbia Institute for Tele-Information), Omar de León (ECLAC consultant), Priscila López (ECLAC consultant), Judith Mariscal (CIDE, Mexico), Fernando Rojas (ECLAC), Christian Ruzzier (San Andrés University, Buenos Aires).

The opinions expressed in this document, which has not undergone editorial review, are the sole responsibility of the authors and may not coincide with the views of the United Nations.

This document was produced with the financial assistance of the European Union. The opinions expressed herein do not necessarily reflect the official opinion of the European Union.

This work was conducted with the help of a grant from the International Development Research Centre, Ottawa, Canada.

This document may be downloaded at [www.cepal.org/Socinfo](http://www.cepal.org/Socinfo).

## Index

<b>Foreword</b>	5
<b>Presentation</b>	7
<b>Introduction</b>	9
<b>I. Broadband and the digital revolution</b>	
<i>Valeria Jordán and Omar de León</i>	13
A. Broadband as a general-purpose technology	14
B. Driving forces behind broadband development	21
<b>II. The contribution of broadband to economic development</b>	
<i>Raúl L. Katz</i>	49
A. Introduction	49
B. The impact of broadband on economic growth	50
C. The contribution of broadband to the performance of small and medium-sized enterprises	68
D. Economic impact of broadband in Latin America and the Caribbean	70
E. Conclusion	75
<b>III. Broadband: the new digital divide</b>	
<i>Valeria Jordán</i>	81
A. From a one-dimensional to a multidimensional gap	82
B. The magnitude of the digital divide	89
<b>IV. The broadband divide as a rapidly moving target</b>	
<i>Priscila López and Martin Hilbert</i>	119
A. Capacity for digital communications over the Internet	119
B. Three general conclusions	138

**V. Broadband tariffs: benchmarking and analysis**

<i>Hernán Galperin and Christian Ruzzier</i>	143
A. Introduction	143
B. The broadband performance index	145
C. Price and quality indicators	150
D. Estimating the effect of price on broadband demand	160
E. Broadband affordability	166
F. Conclusions	173

**VI. The opportunities and challenges of mobile broadband**

<i>Ernesto M. Flores-Roux and Judith Mariscal Avilés</i>	183
A. Introduction	183
B. The status of mobile broadband in Latin America	184
C. Mobile broadband: an opportunity for development	192
D. Challenges in taking advantage of the potential of mobile broadband	199
E. Conclusions	207

**VII. Policies for broadband development**

<i>Roxana Barrantes Cáceres</i>	211
A. Introduction	211
B. Lessons from international experiences	214
C. Broadband development policies in Latin America and the Caribbean	221
D. Conclusions and recommendations	231

**VIII. Broadband policies in Latin America and the Caribbean**

<i>Hernán Galperin and Fernando Rojas</i>	245
A. Develop and implement national broadband plans	247
B. Develop a favourable regulatory environment	249
C. Carry out public investment in basic infrastructure	251
D. Create incentives for demand and promote skills	254
E. Increase the availability of radio spectrum	257
F. Promote regional coordination	258

## Foreword

The structural constraints holding back the development of Latin America and the Caribbean give rise to persistent gaps in production (investment, productivity and innovation) and in society (poverty, exclusion and unequal income distribution). Over the years, this issue has been an ongoing concern of the United Nations Economic Commission for Latin America and the Caribbean (ECLAC). Since its establishment in the late 1940s under the leadership of Raúl Prebisch, the Commission has underscored the fact that the central challenge to be met in order to overcome the region's position at the periphery of the global economic system is to close the technological divide between the countries of the Latin American and Caribbean region and those situated at the centre of that system.

With the development of information and communications technologies (ICTs), particularly broadband Internet, this proposition becomes more relevant than ever, as these technologies constitute the platforms that underpin modern economies and societies. Ongoing technological progress in broadband Internet creates sources of information and knowledge that promote widespread innovation across all economic and social activities. In particular, these advances can result in higher productivity, more competitiveness and greater social inclusion by facilitating access to e-education, e-health and e-government services.

Rapid technological change poses a risk, however: the constant emergence of new technologies and applications demands the ongoing adjustment of policies in order to avert even greater lags in the positive impacts of digital development. Moreover, since broadband's potential use for spurring economic and social development can be realized only if the general population, economic agents and governments can make use of it, broadband access should not be constrained by considerations of private profitability.

This study is based on the premise that broadband is the core element of a technological, organizational and social innovation system which, through the interaction of complementary assets (infrastructure, skills, production structure), gives rise to a process whereby social and production sectors become part of a virtuous development circle. The creation of this synergy calls for new policies based on a holistic, flexible, long-term approach encompassing the objectives of greater productivity, innovation, competitiveness, social inclusion and sustainability. Within this context, the State must play an active role in capacity-building for the design of tools and coordination of actions that will help it to address the structural challenges posed by the digital revolution.

This publication is the result of a joint effort by the Regional Dialogue on the Information Society (DIRSI) and the ECLAC Division of Production, Productivity and Management, which is conducting a long-term regional programme on the information society in Latin America. This effort has the financial support of the European Union through the Inclusive Political Dialogue and Exchange of Experiences Project of the Alliance for the Information Society 2 Programme (@LIS2). DIRSI and ECLAC are making this publication available to governments and citizens of Latin America and the Caribbean in an effort to provide an overview of the dynamics of broadband expansion and use in the region with the hope that it will contribute to a better understanding of this process and to the formulation of policies to promote the development of more modern, innovative and inclusive societies.

**Alicia Bárcena**

Executive Secretary of the Economic Commission  
for Latin America and the Caribbean (ECLAC)

## Presentation

The rapid development of information and communications technologies over the past two decades has made us both witnesses to and actors in a technological revolution which is having a profound impact on all aspects of human life. From a historical perspective, it is clear that we are on the threshold of an unprecedented transformation. After thousands of years of progressive, gradual development, humanity has now embarked upon a process of technological change which is transforming the world at a dizzying pace and carrying it in an uncertain direction.

Framed in this context of rapid technological change, the development of broadband, as with all innovations, brings with it valuable benefits for human development, but also significant risks. A timely and effective response to these challenges must be guided by proposals grounded in a solid understanding of the issues, with the support of evidence and experience. Bold proposals that offer unorthodox solutions based on a forward- and outward-looking perspective are needed. The analyses presented in these pages reflect all of these elements.

The communications infrastructure in Latin America and the Caribbean has evolved a great deal in the last two decades. Gone are the days of long waiting periods between a request for a telephone line and its installation (when, that is, coverage was available at all). The development of more effective ways to handle social and economic problems in the region has not, however, kept pace with this process of technological change, and the Latin American and Caribbean region continues to “distinguish itself” for its high levels of inequality.

Broadband can be used to forge new frontiers for regional development. It can serve as a tool for reducing social and economic inequities or, on the

contrary, it can sharpen these inequities, allowing a few to undergo “hyper-development” while leaving many in a state of poverty and marginalization. The scale and nature of the impact of broadband in the region will depend on the policies that are designed and implemented in the years to come.

The authors of this book, all of whom are experts on the topics covered, offer valuable advice and strategies for the development of public policies, and they do so on the basis of incisive analyses of such subjects as the role of the State and the private sector in the development of broadband, the role of regulation in market growth and service access, demand incentives, and the proper management of scarce resources such as the radio spectrum.

In summary, it is clear that broadband is a high-impact innovation in terms of economic and social development as the region works to build the information society. It is for this reason that any public policy related to its development and implementation should focus on effectively incorporating considerations of equity and equal opportunity rather than simply on moving towards the technological frontier without reference to the broader social context.

**Ben Petrazzini**

International Development  
Research Centre (IDRC)



## Introduction

Well in *our* country”, said Alice ...  
“you’d generally get to somewhere else,  
if you run very fast for a long time as we’ve been doing.”  
“A slow sort of country!”, said the Queen.  
“Now, *here*, you see, it takes all the running you can do,  
to keep in the same place. If you want to get somewhere else  
you must run at least twice as fast as that!”

*Through the Looking-Glass and what Alice found there, II*

The Internet has opened up a new era in telecommunications and has totally transformed everyday activities by increasing the efficiency of information creation and exchange. Telecommunications networks are a crucial part of the infrastructure for economic and social development because they support all kinds activities, from entertainment to the production of goods and services. Electronic applications also play an important part in addressing social problems in the areas of education, health, government and, more recently, environmental protection.

Broadband Internet facilitates this process by enabling seamless connectivity, a greater flow of content, and access to advanced services that involve moving large volumes of data (audio and video, interactive services, etc.). As a result, broadband creates opportunities not only for the improvement of communications, but also for the development of new applications to provide online services that used to be limited by existing technologies’ transmission speeds.

Electronic services are an instrument for overcoming economic and geographic barriers that hinder efforts to ensure social service coverage for the poor. In education, broadband allows not only the provision of remote services, but also access to a wider range of cultural information and multimedia applications that facilitate teaching and learning. Broadband can also be used for remote medical diagnosis and monitoring. In public administration, it makes it possible to streamline service delivery in addition to increasing the transparency of administrative processes and facilitating citizen participation.

In addition, broadband serves as a tool for increasing efficiency in production and management through the use e-business and e-commerce applications, as well as for opening up new markets and facilitating the development of new business models. It also permits the use of applications to improve telecommuting, thereby contributing to greater labour flexibility and increased employment, particularly in more vulnerable segments of the population.

Finally, broadband enables the use of communications and entertainment applications that enhance the well-being and social inclusion of population segments with widely varying interests. Entertainment is probably the area in which broadband has had the strongest and most obvious impact on everything from advanced applications for downloading music and movies to social interaction and online gaming. Furthermore, social networks, voice over IP, blogs and photologs, among others, can be used as powerful tools for exercising civil rights and influencing public opinion, in addition to facilitating social interaction and creating virtual meeting spaces.

The use of broadband entails a variety of complementary elements, such as broadband service access, content and advanced applications, devices and skills. It is not just another technology or telecommunications service. It is a central and decisive component of a new system that incorporates structural complementarities of key importance for economic and social development. It is the hub of a dynamic that involves the entire economy and society in a virtuous circle based on principles of rapid change, efficiency, inclusion and collaboration.

In order to take advantage of all the opportunities and potential of this technology, all elements of the system must be developed, and market forces must be combined with public policy. The economic and social development potential of broadband will materialize only if it is accessible to a substantial and growing portion of the population, economic agents and

public administrators. This is why it is crucial to provide the general public with training in the skills needed to use advanced digital technologies and to ensure access to high-impact online social and economic services.

In this new phase of the digital revolution in Latin America and the Caribbean, public policy must play a more active role in ensuring the balanced development of the broadband system. This is important because broadband gives rise to a new type of digital divide, one which is more dynamic and complex than the gaps seen in fixed and mobile telephony and Internet access. Closing this gap is a matter of urgency, since broadband is a core determinant of competitiveness and social inclusion. A failure to take the necessary action in this area would widen other gaps that already exist in the region, thereby increasing the lag in the countries' development.

These issues are discussed in the following chapters, which deal with subjects ranging from a more general overview of the broadband system to the proposal of specific policy lines. Assessing the dynamic and the economic impact of broadband in Latin America and the Caribbean is a difficult task given the scarcity of information available on these aspects at the aggregate and sector levels. This situation reaffirms the validity of one of the policy recommendations presented in the last chapter, which focuses on the need for significant progress in developing information systems for the design, monitoring and evaluation of public and private efforts.

Finally, as discussed in the last chapter of this book, in order to support action in all of these areas, the agencies responsible for policy design and implementation must be strengthened, and the efforts of the State and of private and social players must be closely coordinated. Moreover, consensus-building within each society is a basic requirement for ensuring the dissemination and use of a technology with such a broad reach. Therefore, if progress is to be made towards building an information society, universal access and use of broadband for economic growth and social inclusion are essential. Given the magnitude of the gap and, above all, the fact that it is widening as the technological revolution proceeds, it is a matter of urgency for the region to move "twice as fast" towards universal broadband access.



## I. Broadband and the digital revolution

Valeria Jordán and Omar de León

Not long ago, when people and companies primarily used the Internet to access information, social and business-related channels of communication, and data links for information transfers, a speed of 256 kbps was fast enough to be classified as a broadband connection. Today, with broadband supporting a wide range of activities, from telecommunications (telephony, television, radio, among others) to social (health, education, government, etc.) services, a speed of 256 kbps is simply not enough. The multimedia and interactive uses made of the Internet today involve downloading and uploading much greater volumes of data.

Broadband has become part of the basic infrastructure for economic and social development, along with older components such as railways, roads and electricity. Many developed countries have adopted policies to stimulate broadband development. In Finland, broadband access has been declared to be a fundamental right, and it has been explicitly stated that all citizens should have access to a high-quality and reasonably priced Internet connection with a download speed of at least 1 Mbps (BBC, 2010).

The analysis presented here will explore how broadband development creates a virtuous circle of increasingly sophisticated and bandwidth-hungry services, applications and content, while broadband's ubiquity, higher capacity and quality stimulate its use for more and better applications that have major economic and social impacts. The first section analyses the effects of broadband as a general-purpose technology, while the second examines the forces driving broadband development which have rendered broadband an indispensable tool in today's information societies.

## **A. Broadband as a general-purpose technology**

### **1. Broadband: an innovation-based system of complementarities**

Information and communication technologies (ICTs) support a wide range of activities, from entertainment to business, and have countless applications that are employed in all sectors of the economy and society. The Internet, in particular, as a general-purpose technology<sup>1</sup> has transformed the way in which economic and social activities are carried out by streamlining the generation, management and exchange of information, and this has had an impact at an aggregate level (ECLAC, 2008 and 2010). Thus, the use of electronic applications is becoming increasingly important in dealing with problems of all kinds, particularly social issues in the areas of education, health, government and, more recently, environmental protection.

Entertainment is perhaps the sector in which the rapid development of advanced applications is the most evident (e.g., real-time voice and video communications, online gaming, movie production and viewing, burning and downloading music, and social networking). Major developments are also being seen in other sectors, such as marketing and information management, where innovations are transforming business models and production processes. These changes are being driven by the availability of tools for decentralizing activities, streamlining processes, managing data intelligently and allowing telecommuting (telework), all of which results in gains in productivity and competitiveness.

The ability to deliver education, health and government services to citizens over the Internet makes it possible to optimize these services and overcome geographic and financial barriers that have made it difficult to reach poor and marginalized segments of the population (Jordan, Peres and Rojas, 2010). In education, broadband services make distance learning possible, but they also provide access to the broader range of cultural information and applications available online, facilitating the development of new teaching and learning models. Broadband also permits the remote delivery of medical diagnostic and monitoring services. In the area of government, streamlining service delivery (the online payment of taxes, for example) increases the

---

<sup>1</sup> The characteristics associated with general-purpose technologies (GPTs) include their permeability as a factor of production in a variety of sectors and their potential for spurring technical improvements and innovative complementarities that, in turn, boost the productivity of research and development (R&D) efforts. As they spread throughout an economy, they therefore result in widespread productivity gains which, at the aggregate level, fuel the overall growth of the economy (Helpman and Trajtenberg, 1998).

transparency of administrative processes and facilitates public participation and access to government information. Table I.1 lists some additional areas in which opportunities have been opened up by applications that assist with the intelligent management of resources.

Table I.1  
**The effects of broadband on economic growth and social inclusion**

Economic growth	Social inclusion
Increased rate of productivity gains	Access to public goods (information and knowledge) free of charge over the Internet
Greater innovation in production and organizational processes through the development of applications that meet the needs of different types of organizations	Access to online public services: education, health, government, citizen participation and others
Job creation	Innovation in social networking applications
Development of technological and production capacities by individuals and companies	Increased well-being due to positive externalities relating to consumption
Greater environmental sustainability due to the use of intelligent tools for managing transport and energy resources	Impact in terms of disaster response and communications

Source: Valeria Jordán, Wilson Peres and Fernando Rojas, "Broadband: an urgent need for Latin America and the Caribbean", ECLAC, United Nations, 2010.

The widespread and effective use of these applications boosts economic and social development. However, certain technological conditions must be in place in order for access devices and networks to support the volumes of data that these tools use. These conditions place constraints on the degree of sophistication and inter-activity of services that can be provided online, as well as on the type of content that can be exchanged or accessed.

Until now, access networks' transmission capacity<sup>2</sup> has limited the extent to which the potential of such advanced interactive and multimedia applications can be exploited. Many technological advances over the past decade have focused on increasing the transmission rate at the level of the subscriber's access or "last mile".<sup>3</sup> In addition, due to the increased interactivity of Internet use, a user's information upload speed has become just as important as the download speed.

<sup>2</sup> The access network, or "last mile", is the part of a communications network that connects service subscribers to the service provider.

<sup>3</sup> See annex I.1 for more information about access technologies.

The potential of the digital revolution is being realized through broadband Internet,<sup>4</sup> as it enables seamless connectivity, greater exchange of content and quality access to advanced services (audio and high-definition video, interactive services and voice over Internet (VoIP), among others). These services create opportunities, not only for improving communications, but also, and most importantly, for developing next-generation applications geared towards online services whose predecessor applications were limited by the transmission speed of existing technologies.

From this perspective, ICTs, and especially the Internet, are general-purpose technologies of which broadband is the most important component. Generally speaking, the impact of general-purpose technologies becomes significant only when one of their components proves to be a disruptive technology that plays a key role in a technological advance. For example, the steam engine would not have revolutionized manufacturing if it had not been for Corliss' design, which made "major improvements in both fuel efficiency and the key performance characteristics...contributing in large part to tip the scales in favor of steam" (Rosenberg and Trajtenberg, 2001). Broadband is to ICTs what the Corliss model was to the steam engine: the technology is a key factor in its success (Federal Communications Commission, 2009).

Because of its economic spillovers, broadband serves as a platform for a broader system, which, in order to operate efficiently, requires the availability of a diverse range of complementary assets: service access, connectivity, advanced applications and content, and the capacity to make use of them. The diffusion of broadband and the capacity for its use are mutually necessary conditions. Broadband is not just another telecommunications service or a faster Internet connection: it is the central element of a new system that offers key structural complementarities for economic and social development (see table I.1). It is the hub for a dynamic that has an impact on the whole of society and on the economy's production sectors that triggers a virtuous circle of development networks based on principles of efficiency, innovation, collaboration and inclusion (ECLAC, 2010).

---

<sup>4</sup> The term "broadband Internet" refers to high-speed data transmission. There is no consensus as to what minimum speed qualifies as a broadband connection. The International Telecommunication Union (ITU), in its standardization recommendation I.113, defines "broadband" as a transmission rate greater than the primary rate of the Integrated Services Digital Network (ISDN), meaning more than 1.5 to 2 Mbits; meanwhile, the ICT statistics area defines broadband as an access speed of no less than 256 kbps in at least one direction (i.e., download or upload). The Federal Communications Commission of the United States (FCC) defines broadband service as the transmission of data at speeds greater than 200 kbps in at least one direction (upload or download). The Organisation for Economic Co-operation and Development (OECD) considers only those connections with upload and download speeds of 256 kbps or higher to be broadband connections in its statistics on the roll-out of broadband in member countries. Generally speaking, this last definition is the most widely accepted one in line with ITU indicators.



Figure I.1  
**The virtuous circle of the broadband system**

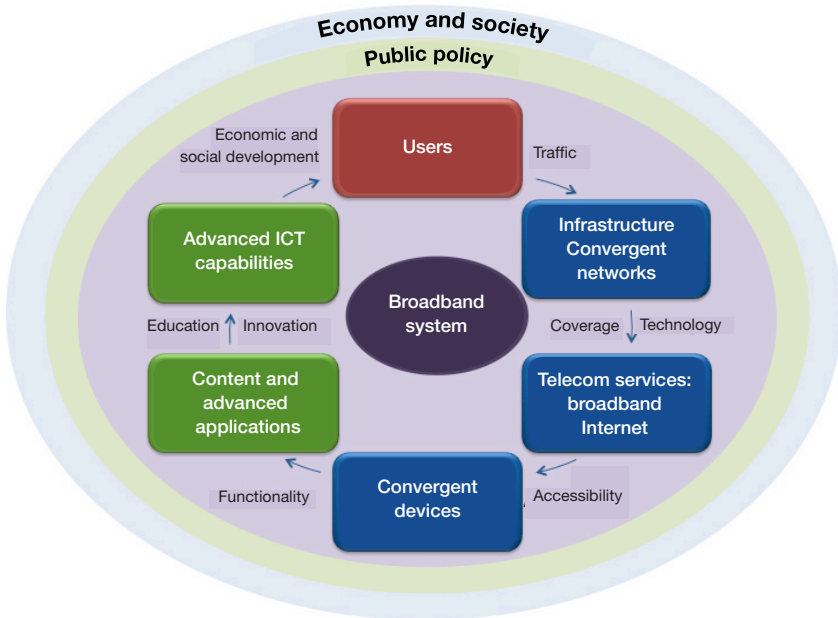

Source: Prepared by the authors.

Within the broadband system, the objective is to maximize the use of its components for the advancement of economic growth and social development. The focal point is the user, i.e., the economic agent (individual, company or organization) that will or will not decide to adopt and use these components to carry out production, social, cultural or political activities.

To achieve this goal, the first requirement is to have telecommunications network coverage with the necessary technologies to meet user demands and needs, along with affordable access to broadband services and broadband-enabled devices to connect up to the network. Having these elements in place is essential in order for users to access content and sophisticated applications. How this content and these application will be used will depend on their purpose (entertainment, employment, access to e-health or e-education, etc.) and users' skills, which are closely linked to users' education levels and any general or specific training they may have had.

The development of broadband therefore sets in motion a virtuous circle in which greater access and a higher quality of connectivity<sup>5</sup> are conducive to innovation in services, advanced applications and content,<sup>6</sup> which, because they are more demanding in terms of access capacity, require ubiquity, higher speed and better broadband quality (de León, 2010).

The diffusion of broadband will only have the expected impact if it is properly combined with the necessary complementarities in a country's production structures and innovation systems. Efforts to achieve the simultaneous provision of the various components of the broadband system and complementary assets may be hindered by a lack of market coordination. Such situations demand public policies that promote the development of infrastructure and applications with a view to providing mass access and generating knowledge and learning (Cimoli, Dosi and Stiglitz, 2009).

## **2. *Broadband for advanced social service delivery***

The extent of the economic and social impact of broadband depends on how it is used and incorporated by social and productive stakeholders, which, in turn, hinges on the availability of software suited to user needs. Although entertainment-oriented applications increase consumer well-being and profitability in the associated markets, the applications with the greatest social potential are aimed at improving the efficiency and effectiveness of services such as education, health and government. However, applications that have a strong social impact are less well developed than entertainment applications.

Companies and markets do not internalize the network externalities generated by the provision of electronic services in these sectors and, for that reason, the options that they offer are suboptimal. In many cases, the applications that these sectors need are similar to those used in the field of entertainment and communications, such as interactivity, immediacy (real-time communications) and the use of video-based multimedia tools. As in other fields, high standards of connectivity are required in order to ensure the continued provision of social services. Figure I.2 shows the required bandwidths for different application types and degrees of sensitivity to latency in data transmission.<sup>7</sup>

---

<sup>5</sup> "Connection quality" refers to the presence of a suitable connection speed and multifunctional devices with high computing power.

<sup>6</sup> Advanced services and applications require more interactivity and better picture and sound quality, among other factors.

<sup>7</sup> Latency is the delay in communication caused by a lag in the transmission of data packets.

Figure I.2  
**Bandwidth requirements based on type of application**

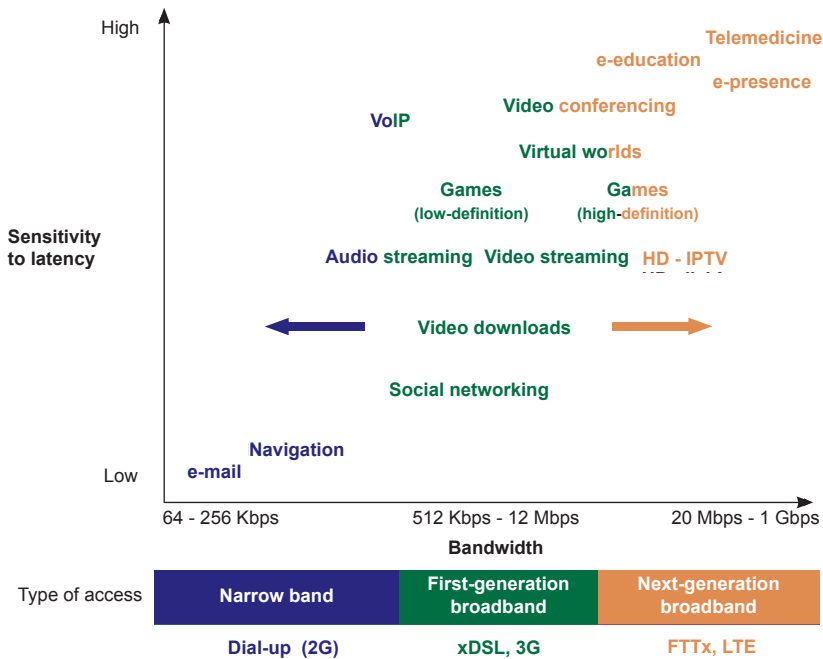

Source: Prepared by the authors based on OECD "Information Technology Outlook 2008," Cisco Systems "Athens Information Technology" and Booz & Co. "Digital Highways: The Role of Government in 21<sup>st</sup>-Century Infrastructure".

Although some applications work at lower speeds, broadband improves the user experience by accelerating Internet access, which in turn facilitates the use of the entire range of electronic services (OECD, 2009). Connectivity requirements in terms of speed and latency are particularly high for health and education applications. E-mail and some other applications are not as sensitive to delays in the transfer of data packets, since whether an e-mail arrives a few minutes earlier or later is not usually very important. In real-time applications, on the other hand, a delay results in a momentary loss of communication, which interferes with the continuity of service.

The use of e-health applications demands certain quality requirements: reliability and redundancy of components, low latency and high-speed symmetrical bandwidth. Patient safety and security require that the networks be reliable and redundant, reducing their vulnerability to system failure. This level of quality in broadband services is generally available in health facilities

in large cities, but not in rural areas, where institutions often have Internet connections similar in quality to residential connections. Health institutions need to have broad symmetrical bandwidth, since e-health communications (X-rays, for example) generally involve exchanging large files in both directions (OECD, 2009). Table I.2 shows the bandwidth requirements for a number of applications in the health sector.

Table I.2  
**Bandwidth quality requirements for e-health applications**

Application: professional e-Health	Application: technology	User		
		Individual 100 Mbps	Small institution 100 Mbps	Large institution 1 Gbps
High-quality, non-real-time video imaging for diagnostic purposes	File transfer	High quality	High quality	High quality
Cardiology, neurology and emergency room consultations	Video H.323	High quality	High quality	High quality
Eco-cardiographs and angiography	Video H.323	High quality	High quality	High quality
3d inter-active brain imaging	SGI Vizserver	Unsupportable	Medium quality	High quality
Clinical decision support systems	Web browsing	High quality	High quality	High quality
Advanced clinical decision support systems	Image transfer	Low quality	Medium quality	High quality
Professional tele-education	Video MPEG 1	High quality	High quality	High quality

Source: OECD, Broadband Workshop 2002, based on "The next Internet: broadband infrastructure and transformative applications," CANARIE Inc., 2001.

In e-education, distance learning applications require different bandwidths depending on their degree of interactivity. Web applications that complement classroom learning with online resources and e-mail communications do not require upload or download speeds over 56 kbps; applications designed to supplement class attendance, on the other hand, require medium- to high-quality connections with symmetrical speeds of 2-5 Mbps. These requirements rise to download speeds of 10-100 Mbps and upload speeds of 5-100 Mbps for fully online courses (OECD, 2009). In addition, low-bandwidth applications become more useful and can be exploited more intensively when high-speed connections are available.

The administration of educational institutions is another relevant area for broadband-based solutions given the volume of information involved in a wide range of activities, from financial management and tracking student information (grades, communications with parents, observations, etc.) to organizing schedules and courses and monitoring curriculum compliance. Applications which organize information and link to regional and national information databases are a useful

tool for decision-making and increase the education system's efficiency, but they require secure, high-speed networks in order to function. Broadband applications also help to improve governance by streamlining the internal workings of administrative units, which in turn facilitates the delivery of services to citizens and information access. There is ample room for innovation in the development of integrated transactional services, and this will entail not only the restructuring of internal management processes, but also the overhaul of the networks, systems and equipment that underpin them. Uninterrupted connectivity makes more sophisticated single-point-of-contact platforms for government procurement possible. These factors can lead to greater efficiency and transparency, giving citizens better access to public institutions and encouraging them to engage in different types of e-democracy.

Once again, the real economic and social potential of electronic applications comes with advanced forms of use, which are only possible through high-speed broadband Internet, in combination with other elements of the system.

## **B. Driving forces behind broadband development**

### **1. Enabling elements**

While it is growing rapidly, broadband use is still just taking off and is being driven by several synergetic and complementary factors.

The components of the broadband system are evolving as a result of innovations in access network technologies, telecommunication services and terminal hardware, as well as interactive, multimedia and collaborative applications. As these components interact, a self-sustaining innovative dynamic is generated that creates new usage patterns which, in turn, promote the system's continued development. Enabling elements of this process are:

- More and better connectivity:

At the end of 2009, there were 490 million fixed-broadband subscriptions and 640 million 3G or superior technology mobile subscriptions in the world (ITU, 2010a).

Globally, the average speed of residential Internet connections increased from 127 kbps in 2000 to 3.5 Mbps in 2009 (CISCO, 2010).

The roll-out of 3/3.5G mobile networks with faster data transmission capacities and WiFi access points (*hotspots*) facilitates the popularization of broadband. An even greater advance in access

speed is expected with the entry of 4G technology, which should make it possible to reach speeds of 100 Mbps and higher.

- Convergent mobile devices:

A variety of multi-functional devices—PCs, notebooks, smartphones, netbooks, tablet PCs and others—with increasingly greater computing capacity have been developed that allow users to generate and transmit large volumes of data and video.

Smartphones are being fitted with features similar to those of small computers, as well as larger, higher-resolution screens and touch QWERTY format keyboards.<sup>8</sup> While maintaining their primary function, these devices are increasingly being oriented towards audio and video uses rather than telephone calls. At the same time, netbooks and the more recent PC tablets combine high mobility and proper functionality.

- Applications for different types of access:

The growing development and sophistication of interactive and collaborative applications—Skype, YouTube, Google Docs, Hulu, among others—have made these applications increasingly attractive to users who have become content-generators in their own right and who are therefore spurring on the formation of online communities (Facebook, Twitter, LinkedIn, etc.).

The development of Web 2.0 applications is changing the way in which users interact and relate to one another and, as their use expands, these applications are migrating to business and government.

Content and applications are available for different types of access and can be adapted to the special features of each one. One example is the supply of applications for different mobile operating systems, specifically Apple iOS and Google's Android; another example is the adaptation of videos—shorter and closer screen shots—for mobile phone screens. Third-party application development is expected to grow faster as operators open up their mobile networks so that they can run all application types, regardless of the operating system. Meanwhile, the development of mobile applications and devices continues to drive wireless broadband.

---

<sup>8</sup> The most widely used arrangement of keys on a keyboard, particularly computers, it is named for the first six letters in the top row of keys.

In recent years, there have been significant technological developments and network launches (WiMAX, LTE, FTTH, IMS, etc.) which are still waiting for suitable applications to be developed. It is expected that, in the coming years, developments will largely be based on known technologies. The great revolution will come when an intensive development of applications and content directed towards sector-specific activities with high economic and social returns outstrips advances in networks and hardware.

- ICT: Earlier digital literacy and the increasing number of users:

The number of Internet users worldwide rose to more than 1.8 billion people in 2009 (ITU, 2010b). As service penetration increases and these services become easier to access through various types of devices, the number of users has been growing rapidly. This includes generations whose members are learning to use these technologies as they go

According to a study by the Pew Research Center's Internet & American Life Project, the percentage of adult Internet users rose from 46% of the population in 2000 to 79% in 2010, and these users are browsing the Internet and using social tools more and more frequently (Anderson and Rainie, 2010a).

Younger generations connect at a younger age. In the countries of Ibero-America, 6 out of 10 children receive their first mobile telephone at the age of 12; 45% choose the Internet over television, and this trend is even stronger among adolescents; 95% of schoolchildren between the ages of 10 and 18 have access to the Internet; 83% have a cellular phone; and 1 out of 2 has a video game console (Fundación Telefónica, 2008).

“Digital natives” are more likely to use integrated and multi-functional devices, adapting the use of technologies to their needs and interests. The Internet helps them with their homework, but it is also a tool for communication and entertainment, with downloading music, videos or photos and chat ranking as favourite online activities. These digital natives are also skilled in handling these devices. While they do talk on their cell phones, they use them primarily to send text messages and exchange photos and videos.

As new generations mature, they will bring greater changes in personal communication and information exchange, especially when they enter the workplace. Communication patterns adopted by digital natives through the use of social networks and other technological tools form

part of their lifestyles. It is expected that they will maintain these habits, even as they grow older, acquire responsibilities and move up the economic ladder. For them, these technologies represent social, economic and political opportunities and they are therefore unlikely to abandon them, although the type of content that they exchange will probably change (Anderson & Rainie, 2010b).

The synergy of these elements is driving irreversible trends in consumer preferences and consumption patterns that have an impact on business models and the development of ICT industries.

## **2. *New modes of access, usage patterns and business models***

### **(a) Moving towards hyperconnectivity via wireless networks**

In recent years, the bandwidth of subscriber access technologies has expanded sharply in both wired and wireless formats, thereby validating Gilder's Law and Nielsen's Law—which indicate that this variable doubles every two years for wired media—and Cooper's Law—which states that the number doubles every two and a half years in the case of wireless technologies (Anderson and Rainie, 2010a).

These developments are being forcefully driven by the technological convergence of networks, services and terminal hardware based on the IP protocol. In this context, next-generation networks (NGN) based on the IP protocol will ensure access to high-speed broadband and provide platforms for the convergence of services so that various applications can be mounted on a single network.<sup>9</sup> This will strengthen the trend towards offering bundled services or “n-play,” in which all services, including telephony, are delivered via broadband.

In fixed media, the main advances are access via copper pair, cable modem and fibre optics. The optimization of the copper twisted pair based on new standards for digitizing the local loop of the telephone subscriber (xDSL) allows high transmission rates: with ADSL2, theoretical speeds of up to 12 Mbps downstream and 2 Mbps upstream can be reached, while ADSL2+ reaches speeds of 24/3.5 Mbps at distances of up to 1 kilometre. The hybrid fibre

---

<sup>9</sup> As defined under ITU-T Recommendation Y.2001 (12/2004), an NGN is a “packet-based network able to provide telecommunications services to users and able to make use of multiple broadband, QoS-enabled transport technologies and in which service-related functions are independent of the underlying transport-related technologies. It enables unfettered access for users to networks and to competing service providers and services of their choice. It supports generalized mobility which will allow consistent and ubiquitous provision of services to users.”



cable (HFC) networks used by cable-television operators can reach top speeds of 40 Mbps in each channel downstream and up to 120 Mbps upstream.

On the other hand, wireless networks have evolved from 3/3.5G+ (which can reach speeds of up to 80 Mbps with HSPA+), with projections of speeds as high as 160 Mbps in the future. With the development of 4G under the long-term evolution (LTE) standard, maximum download and upload speeds of at least 100 Mbps and 50 Mbps, respectively, will be reached. The development of WiFi networks provides access to broadband through the proliferation of hotpots in public areas and is being driven by the rapid, widespread penetration of devices such as the iPhone, iPad and the Samsung Black Jack, among others. This technology can be used to develop a grid and to complement extension projects of network coverage for universal access. Wireless access also allows fixed connections: it is commonplace for fixed computers, i.e., desktops, to connect wirelessly to the Internet. The trend towards fixed and mobile wireless access is here to stay and will strengthen with the launch of 4G.

There is a clear trend towards ongoing connectivity at all times and places through multimedia devices. This, combined with the increased capacity of transmission networks, heralds a more intensive use of advanced applications and a greater demand for more bandwidth.

Device connectivity and the development of residential networks can be added to these uses. It is expected that, in a span of no more than five years, wireless connectivity will consist of network operators and a myriad of devices equipped with sensors and processors to be integrated into private networks, including connections such as M2M (machine to machine). This will make it possible, for example, for households to monitor their power use in order to control their expenses using tools such as Google PowerMeter.

These developments are leading to the creation of an “invisible Web” in which the presence of network connections will no longer be perceived by users. For example, new applications, such as the Semantic Web<sup>10</sup> tend to “hide” the Internet and to screen the huge volume of information that it makes available in order to provide the user only with the information relevant to the task and the context in question.

---

<sup>10</sup> “Semantic Web”, a term coined by World Wide Web Consortium (W3C) director Tim Berners-Lee, describes a group of methods and technologies that allow machines to understand the meaning—or “semantics”—of information on the World Wide Web. It is based on the idea that semantic and ontological metadata that describe content, its meaning and the connections between data so that they can be processed automatically by machines. The objective is to improve the Internet by expanding interoperability between computer systems using “intelligent agents” (Wikipedia, 2010).

The same phenomenon occurs with the new television sets which have built-in widgets<sup>11</sup> and Internet access, allowing users to access their email and Internet television programming as well as to browse the Web, creating a seamless user experience in which users are unaware that these activities are being carried out online. Gradually, users will incorporate information that comes and goes over the Internet into their daily lives without being aware of its origin or destination. Access to information and remote interactivity between people will not require the special procedures that are needed today in order to access the Internet. The difference between physical access and access via the Internet will be erased. These networks and internal connections will use the operator networks for much of their communication, with broadband supporting this trend.

### **(b) Moving towards video-focused convergent services**

Users increasingly employ the Internet to download videos, television shows, movies and general content for free or at a low cost, reflecting a growing preference for this mode of access. The quality of the content available online is driving this trend. Many Internet providers syndicate video content on the Web (news, series, movies, etc.) from television or radio producers who own the copyrights on this audiovisual content. Some sites, such as Hulu, owned by NBC Universal, Disney and News Corporation, are fuelling growth by giving users free access to regular programming within the United States, with the possibility of extending the service to other areas where commercial agreements can be reached. YouTube, for example, has diversified its content beyond the videos uploaded by users and now distributes HD paid content, plus music and movies, thanks to sales agreements with, for example, Warner Music and Sundance Film Festival. With more than 2 billion videos uploaded and played daily and 7,000 hours of movies and shows, YouTube is working to look increasingly like television with its site YouTube Leanback, which, once a video is selected, automatically transmits one video after another based on the user's preferences, without the user having to browse the site (Stross, 2010).

Countries in the Latin American and Caribbean region are largely excluded from this realm of activity for copyright reasons, which becomes apparent if an attempt is made to access content from sites such as MTVmusic, TiVo, Hulu

---

<sup>11</sup> "Widgets", or "Windows gadgets", are small programmes that perform special functions for the user, including the automatic presentation of pre-set information available online (time, weather, stock markets, among others). These applications operate with "push" updates, and information can be presented without being requested each time by the user.

or YouTube channels and Universal Music Group or to buy music on Amazon, Rhapsody or iTunes Store. These services are developed based on the “long-tail” strategy of making a profit on the sale of small quantities of a very large number of products. Thus, as Anderson indicated (2004), focusing all efforts on the sale of a few highly successful products is not the best strategy for the entertainment industry, whose future lies in its ability to harness the millions of small niche markets that are near the end of the production line.

This transformation of the quality of Internet content translates into more competition for cable-television operators. Competition forces them to put part of their programming on the Internet for free, as well as offering exclusive content on demand. This method wins over audiences by offering them the flexibility, of being able to access content outside of set programming schedules. Content distributors upload many of their programmes after they have been aired, picking up an audience equivalent to approximately 15% of the audience that viewed the programming when it first aired. Projections based on these numbers indicate that this area will grow as digital televisions facilitate and improve the viewing experience of online content. According to Time Warner’s CEO, increasingly, younger generations are tending to cancel their pay-television subscriptions, as broadband meets all their needs (Worden, 2010).

Also, thanks to tools such as Apple TV, Internet content which previously could be accessed only through a computer can now be watched on a television or mobile device with a quality similar to pay-television services. This is possible because television and computer screens are now similar in quality and have high-definition connections.

Another trend, as mentioned previously, is the incorporation of widgets into televisions, making it possible to receive mail, watch videos, buy on eBay and obtain information on the Internet about the weather, sports scores and financial news, as well as to connect to social networks such as Twitter or Facebook, among many other activities. This is driving television manufacturers to enter into agreements with content providers such as CBS and Blockbuster and with players such as eBay, Twitter, Joost and YouTube. In January 2009, Yahoo announced its Yahoo! Widget Engine, which includes widgets that bring Internet content to television without going through a computer. This platform, called Internet @ TV, is used with televisions that have broadband connections. Widgets are an interim step towards full and direct access to the Internet and to the applications that the user may want, such as Google, Boxee and Hulu.

Content owners are aware of the changes taking place in the habits of users who seek on-demand content and the ease of PVR (Personal Video Recorder), which can be obtained with IPTV<sup>12</sup> or by accessing online content, especially video.

Moreover, as access to content through the Internet and social networks becomes more popular, online media tend to attract publicity at the expense of traditional media, which marks a shift in the industry's business model. The first casualties were the print media, which watched their circulation fall and, as a result, their advertising revenue drop. Such trends are now starting to affect cable operators and even television channels, given users' preference for accessing online content. These preferences are affecting Internet traffic, which is growing steadily, especially in the case of video-based applications.

Figure I.3  
Global consumer internet traffic, by sub-segment  
(Petabytes per month)

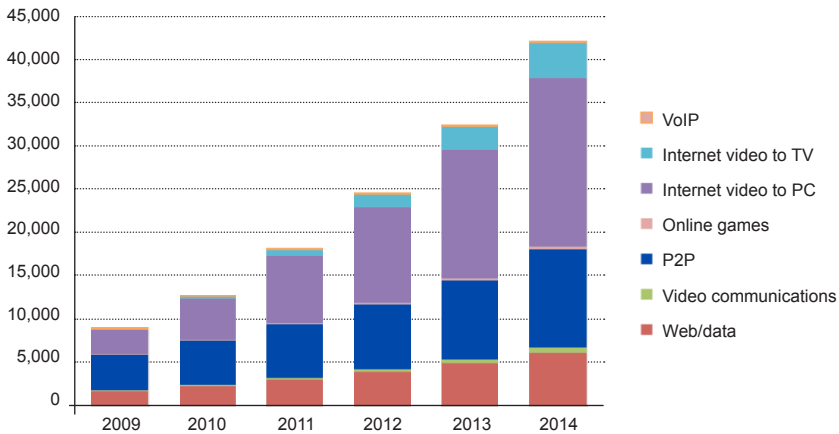

Source: Cisco Visual Networking Index, 2010.

Note: PB: petabyte, a storage unit of information equivalent to  $10^{15}$  or one million gigabytes/gigabytes. Web/data: includes Web browsing, e-mail, instant messaging and data exchange (excluding file exchange). P2P: includes peer-to-peer traffic of all P2P applications such as BitTorrent and eDonkey, among others. Games: includes online game playing, network gaming with game consoles and online games. VoIP: includes consumer VoIP traffic and PC-based services, excluding wholesale VOIP-services. Video communications: includes Internet video calling, video instant messaging, video monitoring and webcam traffic. Internet video to PC refers to online video that is downloaded or streamed for viewing on a PC screen. It excludes peer-to-peer downloads. Internet video to TV: includes video delivered via Internet to a television screen (free or paid) by way of an Internet-enabled set-top box or equivalent device through which users can download film and television content.

<sup>12</sup> Internet Protocol Television: subscription-based distribution systems of television signals or videos using broadband connections under IP protocol.

It is estimated that by 2014 global IP traffic will quadruple, reaching 64 exabytes per month.<sup>13</sup> In 2009, IP traffic amounted to 15 exabytes per month, 80% of which was generated by individuals, with the remaining 20% attributable to companies. User traffic is heavily driven by video transfer, which represented over a third of total traffic at the end of 2009. This could rise to 40% in 2010, even without including the sharing of video files through peer-to-peer connections (P2P). By 2014, Internet video, in particular real-time video, will account for almost 60% of all IP consumer traffic (CISCO, 2010). These indicators point up the need for the continuous expansion and modernization of networks so as to exploit economies of scale and improve the quality of service. This process can lead to greater concentration within the industry, where the boundaries between traditional segments are blurred.

### **(c) Real-time interaction: a real experience in a virtual space**

With the development of a wide variety of devices and the increase in bandwidth capacity, communications are becoming increasingly more immediate. Even the waiting time for e-mail is regarded as excessive in businesses and by hyper-connected young users. Immediacy becomes a requirement of the daily dynamic, encouraged by real-time communications applications such as telepresence and video calls. Simple applications like Twitter are attractive because of their capacity to transmit messages instantly and are seen by companies as a simple way of providing real-time customer service.

Social networks drive this trend by changing the way in which people communicate, in particular through the development of collaborative and interactive visual networking applications<sup>14</sup> that improve users' communication and interaction experience by making it more immediate and real.

The communication experience becomes more "real" with the development of high-definition audio and video. High-definition voice communication (HD Voice) is an important advance in communications that has been made possible by increased bandwidth. In addition to improving

---

<sup>13</sup> Storage unit of information: 1 exabyte = 1,000,000,000,000,000,000 B =  $10^{18}$  bytes = 1 billion gigabytes = 1 million terabytes.

<sup>14</sup> Visual networking refers to an emerging class of user applications that combine digital video and social networking capabilities. In particular, these applications combine entertainment and communications, professional and personal content, video and other digital media, data networks and social networks to create immersive experiences when, where and how the user wants it. Content generation and distribution take on a new dimension with Web 2.0 applications, which facilitate interactive creativity, collaboration and sharing between users (Wikipedia, 2010).

service quality, this technology is necessary in certain environments to improve speech intelligibility (for example, call centres or services for hearing-impaired users). Skype, Google Talk, Yahoo and Nimbuzz have already introduced high-definition voice communications. It is expected that widespread use will boost other bandwidth-intensive services, such as video conferencing and telepresence.

An increase in interactive television user loyalty (made possible by digital television) and in revenue for content providers is expected. The applications generating the greatest interest are video on demand (VoD),<sup>15</sup> video conferencing and access to advanced television scheduling guides. This will also increase access to movies, series, live events, sports and news.<sup>16</sup> In addition to the above-mentioned applications, users want to see photos, their own videos and online information on their television screen, which is simpler to operate and more user-friendly than a traditional computer.

#### **(d) From the computer to cloud computing**

In cloud computing,<sup>17</sup> application storage moves from personal computers to the Internet or private networks (NIST, 2009). The applications are accessed via Web browsers, smartphones or other devices, just as if they were locally installed programmes, thereby reducing the cost of software and data distribution (The Economist, 2009).

Millions of people use these services to interact on social networks such as Facebook, use e-mail services such as Hotmail or Yahoo mail, chat on Messenger or talk on Skype, use blogs such as Twitter, watch YouTube videos, search for information on Google, etc.. In the case of more complex services, one of the leading suppliers is Amazon. The main features of its Amazon Web Services (AWS)<sup>18</sup> include: flexible processing and storage services in line with the user's needs; pay-as-you-go pricing, published rate cards, with no contracts or long-term commitments; access to the same

---

<sup>15</sup> VoD is a system that allows users to select and watch video content on demand, generally delivering content to computers or televisions using the Internet protocol for television (IPTV).

<sup>16</sup> Many of these applications use widgets.

<sup>17</sup> Cloud computing: Internet-based computing through which shared resources, software and information are supplied on demand to computers and other devices (Wikipedia, 2010). This makes it possible to reduce investment in information processing systems by leasing processing, storage and transport services. These services fall into three categories: infrastructure, platform and software. This differs from centralized and managed services for which the user pays for use time, as cloud computing is scalable and can be used as desired whenever required.

<sup>18</sup> <http://aws.amazon.com/what-is-aws/>

infrastructure that supports Amazon's operations, which allows users to choose which applications, platforms and operating systems they want to use; and modules for handling payments, queues and database management, also under a pay-per-use system.

It is expected that most users will access software online and share information through remote server networks, rather than relying on the tools and information stored on their personal computers (Anderson & Rainie, 2010C). With more services available in the cloud, the functionality required for operating systems and equipment processing capabilities will be lower, thereby boosting the development and use of more compact devices whose performance will not be limited by their computing or storage capacity.

The bi-directional traffic of the large volumes of information required for cloud services will increase the demand for reliable broadband connections and a symmetrical relationship between download and upload speeds.

### **(e) New industrial dynamic: ICTs focused on e-applications and services**

The changes outlined in the preceding paragraphs are altering the nature of competition in the computer industry, reversing previous trends towards niche specialization. The shift to mobile computing and cloud computing data centres are driving a greater vertical integration of the industry, whose linkages include the production of microprocessors, hardware, operating systems and applications. Microsoft, Intel, Apple, Google and other major companies, which for years had focused on one or two links in this chain, are now pursuing vertical integration strategies, as new forms of computing require more interaction between different links (see table I.3). For example, Apple is building data centres and offering Web-based services; Google developed the Android operating system for smartphones; Cisco went from being the world's largest manufacturer of data networks to selling servers; Hewlett Packard, a provider of servers, has entered the networking business; and Oracle, a company that sells business software, acquired Sun Microsystems, a computer manufacturer (*The Economist*, 2009 and 2010).

Table I.3  
**Competition in the computing industry**

Company	Apple	Google	Microsoft	Intel	HP	IBM	Oracle	Cisco
Revenues, 2009 (In billions of US dollars)	46.7	23.7	58.7	35.1	117.0	95.8	23.2	35.5
Employees, 2009 (latest available figure)	34,300	19,835	93,000	79,800	304,000	399,409	86,000	68,574
<b>Amount of activity in each market 1=only a little, 2=some, 3=a lot</b>								
Processors	1			3		3	3	3
Computers	3	1			3	3	3	2
Network equipment					3	2	1	3
Mobile devices	3	1	1		3			1
Software	3	3	3	3	3	3	3	
Applications	3		3			1	3	
Web-based services	2	3	3		1	1	2	3
Online advertising	1	3	3					
Cloud computing		3	3		2	3		
IT services /consulting			2		3	3	2	3

Source: The Economist, "Information technology in transition: The end of Intel", July 2010.

The computer industry is not the only one that is changing under the pressure of technological advances. Traditional telecommunications operators (telephone and cable operators), which are at the beginning of the production chain for the distribution of Internet-based services, are the same companies that own the infrastructure and have the operational service capability to provide services and content based on cloud computing applications. In this industry, four major forces are in play: competition among telecommunications operators, network outsourcing, competition between operators and content providers, and the growing importance of new players.

Competition among telecom operators mainly involves traditional telephone operators and pay-television service providers. Their strategic focus is on providing broadband access, which enables them to offer bundled services (e.g., triple-play packages). The increased demand for bandwidth is transforming business models for the sale of access services. There is a trend towards the sale of data transmission services by volume, leaving behind the current prevailing model of unlimited capacity. Thus, the traditional model of charging for telephone time (per minute) may be becoming a thing of the past, with phone calls being routed over the network in the same way as other data flows.

In the recent past, having a good, well-run network made its operator stand out in the eyes of those clients who appreciated these qualities. However, as network quality is tending to become homogenized, it is ceasing to represent a competitive advantage. In this context, the major operators can outsource



the operation and maintenance of their networks and focus on marketing and development of broadband service (their core business).<sup>19</sup> In addition, they are seeking new business opportunities in the areas of content and applications.<sup>20</sup> As a result, in the face of competition from services such as Skype or Hulu, telecommunications operators have developed strategic alliances and new business models to add value to their networks.<sup>21</sup>

Another ongoing trend is the growing role of new players, among them content providers, content distribution networks and traffic exchange points (Echeberria, 2010).

Content providers have moved to centre stage in the Internet industry as key players. In the past, Internet service providers (ISPs) controlled peering agreements (traffic exchange between Internet service providers). Today, companies such as Google, Yahoo, Facebook and eBay negotiate their own peering contracts directly with major Internet service providers. These negotiations are of mutual interest because ISPs want their customers to have good access to the most popular content, while the content providers are interested in reaching potential customers under the best possible conditions.

---

<sup>19</sup> For an operator, network operation and maintenance are highly computerized routine tasks that can be outsourced (de León, 2010). Ericsson, Alcatel-Lucent and Nokia Siemens are signing outsourcing contracts worldwide in the face of strong competition. For example, Ericsson signed contracts with numerous operators, including Hutchison Telecom in Hong Kong, T-Mobile and Vodafone (April 2009) in the United Kingdom, Cable and Wireless in several countries, and Sprint Nextel in the United States. Most recently, Orange Spain signed a similar contract with Nokia Siemens Networks (NSN). And, in July 2009, NSN signed a five-year US\$ 1.5 billion contract with the Brazilian mobile operator Oi to run and maintain the Brazilian company's network across 17 states. At the contract signing, NSN revealed that 45% of its revenue comes from outsourcing services.

<sup>20</sup> In July 2009, CBS became the first broadcast network to join cable operator Comcast's OnDemand Online programme. The programme was piloted for 5,000 Comcast customers who began to receive the same content but through Internet rather than cable television subscriptions. The agreement provided an opportunity to test the copyright protection offered by Comcast's authentication technology, which functions on the subscriber level, as well as a chance to compete with Hulu.com, which offers content from NBC, ABC and Fox. The OnDemand Online trial forms part of Comcast's Project Infinity, whose aim is to make its content available to its clients on any platform and at any time. Meanwhile, also in the second half of 2009, Verizon Business launched its own cloud computing service called Computing as a Service, using its network of data centers throughout the world, in a bid to generate revenue through increased traffic on its network and leases of cloud computing services. In addition, AT&T, British Telecom and NTT DOCOMO in Japan have announced plans to develop a service to compete with Skype.

<sup>21</sup> There are moves towards open networks, such as Verizon in the United States, which is in talks with integrators such as IBM and Accenture, content providers, and platform providers such as Cisco and Microsoft, among others. Verizon aims to "complete its network" in order to meet the consumers' demand for access to a wide range of applications and content online from any terminal. In April 2009, Verizon announced the creation of an innovation centre for the development and testing of LTE devices and applications, primarily in the areas of consumer electronics (wireless video cameras, books readers, etc.), machine-to-machine communications and applications that give productivity tools mobility. In the same vein, AT&T announced that it was opening up a centre to develop wireless broadband devices; Qualcomm created a centre for the development of solutions in health; and, in July 2010, Telefonica presented its Global e-Health Unit for the development of applications for the decentralization of clinical trials, virtual patient care and videoconferencing for medical professionals.

As the importance of content providers increases, content distribution networks (CDN) that use their own distribution infrastructure have also gained ground. CDNs are run by operators that own networks with nodes in various parts of the world, possess good infrastructure and have sound connectivity. They sell their services to content providers, making their content available and accessible under suitable condition for users around the world. The commercial success of CDNs depends in large part on their capacity to negotiate and maintain good peering arrangements with the ISPs in the markets they want to reach, since only under these conditions will their networks be attractive to content providers.

Traffic exchange points (network access points (NAPs) or Internet exchange points (IXPs)) have existed for years. Initially, operators formed associations or partnerships with other operators to exchange traffic locally, avoiding the cost of international links. Over time, more commercial IXP models were developed on the basis of exchange points at which ISPs could connect physically and negotiate peering agreements with other ISPs, content providers and content distributors in the same location. These types of models, which connect companies that want to trade traffic as part of the same IXP, facilitate the negotiation of peering agreements and their implementation, which is usually accomplished through the programming of switches and routers.

The industry is undergoing striking structural changes, with one of the most notable changes of all being the increasing degree of concentration within the Web: 75% of the pages visited in 2010 in the United States belonged to just 10 websites, compared to 31% in 2001. This high concentration replicates the model of the traditional media—a few very powerful players versus a large number of virtually powerless ones and strong vertical integration—and points to a loss in the share of the Web relative to video traffic and traffic on dedicated, closed social networks. This process is driven by technological convergence, as well as by user preferences, which seem to be moving away from Web browsing and towards the use of applications on dedicated devices. Currently, the paradigm appears to be the one created by Steve Jobs at Apple, which combines hardware, applications and content in a closed system (iPod, iPhone, iPad, iTunes, IOS). This could herald “the death of the Web” as more closed forms of Net usage gain sway (Anderson, 2010 and Wolff, 2010).

## Annex I.1

**Broadband access technologies**

The infrastructure that supports the convergence of technologies can be divided into layers: terminals, access, transport, control and applications. These layers constitute the structure of the IP Multiservice Subsystem (IMS), the architecture that fixed and mobile networks are moving towards around the world. The most important of these layers, inasmuch as it has been the main constraint for broadband, is the access layer. Here, there are diverse wired and wireless link technologies that allow fixed or mobile access to broadband (see figure A.1). The main ones in the first category are copper pair (xDSL),<sup>22</sup> fibre optics (FTTx),<sup>23</sup> coaxial cable (cable modem) and the power grid. The most operationally developed wireless technologies are third generation (3G) mobile networks and, more recently, fourth generation (4G) ones, in addition to wireless local area networks (WLAN) and access via satellite, among other commonly used technologies.

Figure A.1  
**Broadband access technologies**

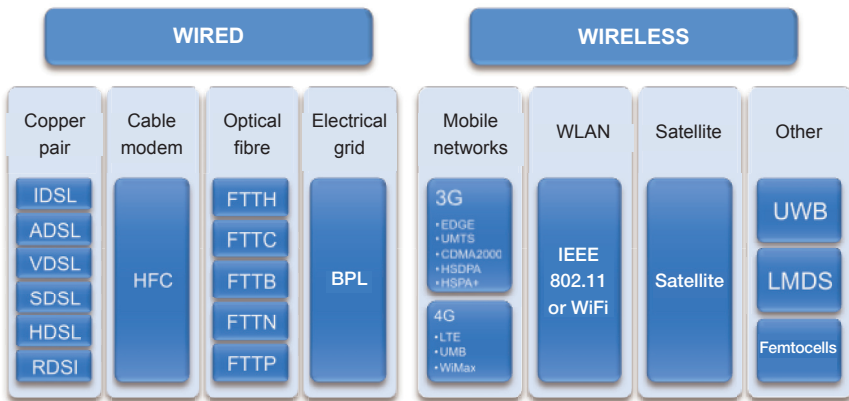

Source: Prepared by the authors.

<sup>22</sup> The X Digital Subscriber Loop includes a set of technologies that enable high-speed digital access over the existing copper wires of the local loop.

<sup>23</sup> FTTx (fibre to the x) is a generic term referring to the many types of *broadband* network architecture that use optical fibre, which varies depending on the network's scope and proximity to the end user: FTTE (fibre to the enclosure), FTTB (fibre to the building), FTTC (fibre to the curb), FTTH (fibre to the home), FTTN (fibre to the node/neighborhood) and FTTP (fibre to the premises).

## **A. Wired technologies**

### **1. Copper pair (xDSL)**

The xDSL access technologies are based on the digitization of the telephone subscriber loop to convert the basic telephone network's twisted copper pairs into a high-speed digital line capable of supporting broadband services and voice communications simultaneously. This functionality makes it possible to reuse existing infrastructure, which accounts for its widespread deployment around the world. However, its information transport capacity is insufficient for more advanced stages of Internet usage, where large volumes of data are exchanged.

This type of access encompasses various technologies, including ADSL (asymmetric digital subscriber line), HDSL (high data rate digital subscriber line), SDSL (symmetric digital subscriber line), IDSL (ISDN digital subscriber line), VDSL and VDSL2 (very high speed digital subscriber line).

The speed of the service depends on the distance between the subscriber's home and the telephone company's nearest facility. In general, the speed indicated by the provider is only theoretical, as actual speeds are largely dependent on factors such as the quality of the external network and the number of services running on the same backbone cable of copper pairs, among others. ADSL allows higher download speeds than upload speeds from the subscriber's computer to the telephone exchange. There are various asymmetrical data transmission standards on the loop as a result of its technological evolution since 1998, when the first ADSL Lite standard was published, making it possible to reach 1.5 Mbps download speed and 512 kbps upstream over distances of from three to five kilometres from the telephone exchange. New standards set theoretical speeds of up to 12/2 Mbps ADSL2 and 24/3.5 Mbps in ADSL2+ over distances up to one kilometre.

Completing this technological trajectory is the VDSL2 (very high bit-rate digital subscriber line 2), which allows very high theoretical speeds of up to 100/100 Mbps at distances of less than 500 metres from the distribution node; at distances greater than 2 kilometres, its performance tends to be similar to ADSL2+. In general, these technologies' download speeds do not exceed 30 to 50 Mbps. Although announced for 2006 and 2007, worldwide VDSL2 deployments began in early 2008, when the technology, which was standardized in 2005, had matured. This technology allows telecom operators to compete with cable operators, since both must bring fibre optic lines close to their customers.

## 2. Cable modem

The cable modem is a special type of modem used by cable television providers to send data signals through their infrastructure, making use of free (unused) bandwidth in the cable television distribution system and bandwidth that is released for providing Internet access. Under this modality, convergent packages of television, telephony and data are commonly available at competitive prices (e.g., triple-pack services).

In order to operate bi-directionally, cable modems use the channel spectrum previously earmarked for television for downstreaming and the reserved bandwidth for upstreaming. In order to permit the use of these bands, the specification called DOCSIS (Data Over Cable Service Interface Specification), which is certified by CableLabs, was developed. This specification covers several aspects of interoperability between the CMTS (cable modem termination system) located at a *cable* company's hubsite and the CM (cable modem) located at the customer's location.<sup>24</sup>

The data rate that is obtained depends on modulation and the bandwidth allocation. Under the standard used in the United States, downstream channels are 6 MHz and upstream channels are from 0.2 MHz to 3.2 MHz. Typically, download speeds run 38 Mbps on a 6 MHz channel and uploads run 9 Mbps on a 3.2 MHz channel. Subsequently DOCSIS 2.0 made 30 Mbps upload capacity available on a 6.4 MHz channel. The most recent approved protocol, DOCSIS 3.0 (2006), which allows channel bonding, can reach up to 40 Mbps download capacity per channel and up to 120 Mbps upload capacity. This standard supports IPv6 and IPTV (Internet Protocol TV), making it possible for cable television operators to compete with telecom operators in providing on-demand television services. For the European standard (Euro-DOCSIS), capabilities are higher because it uses 8 MHz channels, and the spectrum reserved for upstream traffic is from 5 MHz to 65 MHz. Speeds of as much as 52 Mbps per 8 MHz channel can be reached with a modulation of 256 QAM (quadrature amplitude modulation).

While the speeds are comparable to xDSL, this technology's upstream channel is subject to physical constraints caused by two factors: one is the low bandwidth reserved for such use; the other is the presence of noise which prevents the use of the entire upload bandwidth. Moreover, the upload

---

<sup>24</sup> These DOCSIS standards were adopted early on (August 1997), before ADSL standards, and were first used before 1998, when they were officially approved by ITU in its DOCSIS version 1.0. The DOCSIS version 1.1 enabled VoIP, QoS and authentication.

bandwidth is shared by all the clients connected to the same coaxial cable node, which means that the connection speed depends on the number of people using the service simultaneously. This forces cable operators to connect nearby nodes with customers utilizing fibre optics, for which they use hybrid fibre-coaxial (HFC) networks.

### 3. Fibre optics (FTTx)

Fibre optic technology converts electrical signals carrying data over waves of light that do not reach the visible spectrum and then sends them through transparent glass fibres with a diameter close to that of a human hair. Fibre transmits data at speeds faster than other technologies such as xDSL or cable modems, although the actual speed depends on factors such as available bandwidth and service configuration.

There are several ways to access this technology, depending on the density of the area to cover: fibre to the cabinet (FTTCab), fibre to the curb (FTTC), fibre to the premises (FTTPremise), fibre to the home (FTTH), fibre to the building (FTTB) and fibre to the node (FTTN) (as in the case of cable modem access in HFC networks). Only FTTPremise access in its FTTH and FTTB versions is a pure case of fibre to the customer, since the other fibre-optic access technologies include short final tracts of coaxial cable or copper pair (see figure A.2).

Figure A.2  
Fibre optics access modes

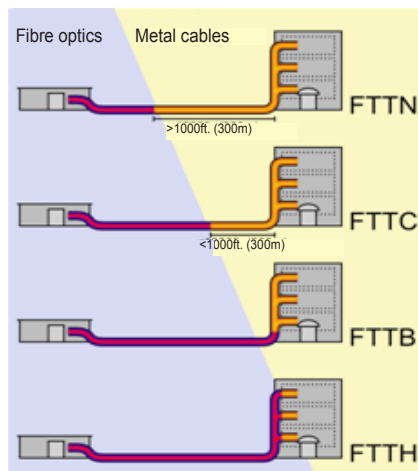

Source: Wikipedia.

Passive optical network (PON) technology is the most used and least expensive in FTTP networks because the distribution of signals does not involve the use of active elements on the net until it reaches the customer. When the fibre reaches a building, generally, the fibre network is continued on to the end user using a splitter. In other cases, the final access consists of a copper pair and VDSL2 or coaxial cable and DOCSIS links on subscriber television operator networks. The transmission mode for downstream is by wavelength division and distribution encoded on each wavelength for individual reception. Upstream, terminal equipment transmits in the time slot indicated by the central computer in time division multiplexing (TDM) mode.

Active FTTP technologies include active equipment packet switching, including routers, switches or multiplexers, and in general use Ethernet to form a network of clients linked to the operator.

#### **4. Broadband over power lines (BPL)**

Broadband over power lines (BPL) is the service offered through low- and medium-voltage electric energy distribution networks to transmit digital signals which can carry data at high speeds. BPL transmission rates are comparable to DSL and cable modems.

Although BPL has great potential because the electrical infrastructure is already installed and has broad coverage, there are as yet no major commercial deployments for two reasons. On the one hand, there is no standard mechanism to regulate network access; on the other, the tests performed using proprietary BPL protocols have been problematic, forcing many companies to shut down operations.

In view of the deployment of other technologies and the advance of wireless access, it is more than likely that BPL may be used for onsite transmission, but not for access.

### **B. Wireless technologies**

Wireless broadband uses a radio link between the customer's access point and the service provider's facility, which may provide fixed or mobile services.

Initially, wireless technology provided fixed access with limited mobility in closed areas using short-range delivery technologies. Subsequently, the development of wireless technologies with a longer range made it possible to provide broadband services in remote or sparsely populated areas where it would be costly to provide

wired broadband technologies. Finally, technological advances have enabled the development of mobile wireless broadband, which is primarily offered by mobile operators. Although at present this service offers lower access speeds than fixed broadband, it is becoming a vehicle for broadband access growth, spurred by the exponential growth of data traffic from mobile devices.

The significant and rapid advances made by these technologies have allowed them to become progressively more competitive, to the point where it is starting to look like they may be just as important a market as wired access services, which could lead to the elimination of natural monopolies in this latter category. In addition, given their lower cost and greater coverage, wireless technologies will be the main tool for the universalization of telecommunications (telephony as well as broadband) and the multiple associated services (León, 2009).

## **1. 3G mobile technologies**

This category includes several technologies defined in the IMT-2000 standards of the International Telecommunication Union (ITU), which are, in turn, subdivided into two major groups: 3GPP<sup>25</sup> (created in 1998 to coordinate GSM,<sup>26</sup> EDGE,<sup>27</sup> UMTS,<sup>28</sup> and other such technologies) and 3GPP2<sup>29</sup> (CDMA2000, EV-DO, among others). The technologies in the first group seem to be the ones that will dominate in the migration to 4G technologies.

Broadband data transmission starts with general packet radio service (GPRS), a packet-oriented mobile data service available to users of second-generation (2G) and third-generation (3G) GSM (global system for mobile communications) cellular communications systems. Initially, time slots between voice packets were used to transmit data; later, multislots came into use thanks to optimization with EDGE technology. 3G was launched along with Evolved EDGE, which leads to much higher transfer rates. EDGE is the first technology that was considered to be 3G by ITU, although sometimes it is classified as 2.5G.

---

<sup>25</sup> 3rd Generation Partnership Project (3GPP): A cooperation between groups of telecommunications organizations to develop standards for the 3G mobile telephone system to be applied globally within the context of the International Mobile Telecommunications 2000 project of the International Telecommunication Union (ITU). 3GPP is working on the standards for the evolution of the global system for mobile communications (GSM).

<sup>26</sup> Global system for mobile communications.

<sup>27</sup> Enhanced data rates for GSM Evolution (EDGE)

<sup>28</sup> Universal mobile telecommunications system.

<sup>29</sup> 3GPP2 represents the group of telecommunications organizations working on the definition of 3G standards based on CDMA technology within the framework of the ITU IMT-2000 project.



In 2001, W-CDMA (UMTS release 99) was first implemented using a 5 MHz channel for voice and data access. (In GSM, the channel is 200 KHz.) This technology was deployed in overlay to GSM networks, and its use led to the growth of a market that justified the deployment of HSDPA (high-speed downlink packet access) and HSUPA<sup>30</sup> (high-speed uplink packet access); these more advanced 3G technologies allow *high-bit-rate packet transfer* on the way to 4G — the total integration of systems and networks based on IP protocol.

Continuing the trend towards 4G, 3GPP is developing other versions that use HSPA+ on more than one 5 MHz channel, thus improving the service. Along the same path as 3GPP, 4G networks will use an enhanced version of LTE, which is attracting interest in connection with the direct migration from HSPA to LTE.

The deployment of all-IP HSPA+ networks defined in 3GPP version 7, which reach data speeds close to those expected for 4G, has recently begun. It is expected that, in Latin America and the Caribbean, operators will migrate directly towards HSPA+ before LTE,<sup>31</sup> despite the latter's expected growth in the rest of the world. There are several reasons for this trend: problems in obtaining terminals, new spectrum band requirements, the need for large investments in a market that has yet to mature in regard to technologies that are already on the market, and the extent of resource-sharing ability with WCDMA/HSPA networks.

Table A.1 reflects the theoretical maximum speed of data transmission for the technologies just mentioned,<sup>32</sup> although the speeds actually reached are lower.

Table A.1  
Data transmission speed, by technology

Technology	Download	Upload
EDGE	474 kbps	474 kbps
Evolved EDGE	1.9 Mbps	947 kbps
UMTS (W-CDMA 5 MHz)	2,048 Mbps	768 kbps
CDMA2000 1x RTT	307 kbps	307 kbps
CDMA2000 1xEV-DO Rev.0 1.25 MHz	2.4 Mbps	153 kbps
CDMA2000 1xEV-DO Rev.A 1.25 MHz	3.1 Mbps	1.8 Mbps
CDMA2000 1xEV-DO Rev.B 5 MHz	14.7 Mbps	4.9 Mbps
HSDPA 5 MHz	14.4 Mbps	384 kbps
HSDPA/HSUPA 5 MHz	14.4 Mbps	5.76 Mbps
HSPA+ (3GPP version 7)	42 Mbps	11.5 Mbps

Source: de León, Omar (2009), "Perspectivas de las tecnologías de telecomunicaciones y sus implicancias en los mercados y marcos regulatorios en los países de América Latina y el Caribe," ECLAC.

<sup>30</sup> Evolved HSDPA, commonly called 3.5G plus or 3.75G.

<sup>31</sup> Long Term Evolution: new standard of the 3GPP, known as mobile 4G.

<sup>32</sup> See "3G Americas, EDGE, HSDPA and LTE: The Mobile Broadband Advantage".

## 2. 4G mobile technologies

ITU is working on the International Mobile Telecommunications-Advanced (IMT-Advanced-4G) system and is analysing various technologies with a view to their inclusion in the category of fourth-generation mobile networks. So far, 4G definitions are solely a function of operators' and suppliers' commercial needs.

ITU established the 4G requirements first, before analysing the technologies and verifying their compliance with those requirements, in line with the organization's standard procedures. Its radiocommunications sector (ITU-R) has made substantial progress in developing these initial definitions, which were issued as ITU-R Report M.2134. According to the timeline defined for this process, it is expected that the final definition of IMT Advanced or 4G interfaces will be ready in 2011. Document IMT-ADV/1-E established the main features for the air interface of IMT Advanced: (i) A wide scope of shared functionality around the world; (ii) the compatibility of services within IMT and fixed networks; (iii) seamless interoperability with other radio access systems; (iv) high-quality mobile services; (v) compatible terminals worldwide, (vi) user-friendly applications, equipment and services; (vii) global roaming; and (viii) high speeds for advanced applications and services with a target transfer rate of 100 Mbps for mobile terminals with a travelling speed of up to 150 km/h and a 1 Gbps stationary bandwidth for nomadic or fixed links. Additionally, they should be all-IP systems that are fully converged with fixed networks.

There are three possible 4G technologies — IEEE 802.16m,<sup>33</sup> LTE and UMB<sup>34</sup> — that are competing for the first deployments while the ITU standard is completed. Although LTE is known commercially as a 4G technology, the first version is really a 3.9G technology, as it does not fully comply with the requirements of IMT Advanced. This standard is a step towards LTE Advanced, which will be a true 4G technology.

3G technologies managed by the 3GPP and 3GPP2 groups have remained in operation. On the threshold of 4G, while each of these groups has its technology (LTE and UMB), the first is driving market expectations, and it appears that UMB will not be launched commercially. In December 2008,

---

<sup>33</sup> Wireless broadband standard of the IEEE 802.16 family developed by IEEE (Institute of Electrical and Electronics Engineers), marketed under the name WiMAX (Worldwide Interoperability for Microwave Access).

<sup>34</sup> Ultra Mobile Broadband: 3GPP2 standard.

Verizon Wireless announced that it had decided to deploy LTE instead of UMB in the roll-out of its 700 MHz-based network; this decision affirmed the 3GPP2 standard and illustrated the strength of LTE vis-à-vis UMB, which has led to its accelerated global deployment. AT&T and T-Mobile also plan to deploy LTE, which may be the death knell for UMB; however, they plan to wait between two and three years before they initiate deployment. Another blow to UMB was the decision on the part of the technology's main sponsor, Qualcomm, to abandon UMB development in November 2008 and to focus on LTE instead.

WiMAX technology (IEEE 802.16m) is expanding internationally and doing so quite strongly in some Latin American countries.

Table A.2 presents the main characteristics of the three technologies cited above.<sup>35</sup>

Table A.2  
4G mobile technologies

Technology	Standard	Preceding standard	Bandwidth	Download/Upload speed
LTE	3GPP	HSPA	1.25 a 20 MHz	173 Mbps/58 Mbps in 20 MHz. Difficulty in reaching 1 Gbps with a fixed link.
UMB	3GPP2	CDMA2000	1.25 a 20 MHz	140 Mbps/34 Mbps at 20 MHz
802.16m	WiMAX Forum	802.16e	5 a 20 MHz	Up to 30 Mbps download using a 20 MHz channel. Difficulty in reaching 1 Gbps with a fixed link.

Source: de León, Omar (2009) "Perspectivas de las tecnologías de telecomunicaciones y sus implicancias en los mercados y marcos regulatorios en los países de América Latina y el Caribe," ECLAC.

### 3. *Wireless local area networks (WLAN)*

Wireless local area networks (WLAN) are used to provide wireless broadband access over short distances. Wireless Fidelity (WiFi) technology emerged in response to the need for wireless broadband access in enclosed spaces such as offices and homes. Then it was extended to public places such as airports, restaurants and cafes, through free or paid hotspots. Some hotspots allow users to mesh, meaning they can access one another to form a network. This method can cover a relatively small area, such as a city of 20,000 people, using a few access points to connect to the backbone and then relaying broader coverage through the network of WiFi hotspots.

<sup>35</sup> These characteristics are indicative, since more antennas or different bandwidths can be used. For example, WiMAX has the following downlink peak spectral efficiency: 8 bps/Hz for 2x2 antennas and 15 bps/Hz for 4x4 antennas. Also, the data transfer rates depend on the terminal's travelling speed, falling off quickly when that speed exceeds 120 kilometres per hour.

The latest versions are the following:

802.11b. uses the 2.4 GHz ISM band and covers up to 100 metres indoors up to a speed of 11 Mbps.

802.11g. also uses the 2.4 GHz band but offers a speed of up to 54 Mbps.

802.11n. uses two frequency bands (2.4 GHz and 5 GHz) and reaches data transmission speeds of up to 600 Mbps. It can attain speeds up to 10 times greater than its predecessors and uses the less congested 5 GHz band. It was put forth in an Enhanced Wireless Consortium proposal approved in 2006 by the IEEE 802.11 working group. It is estimated that it can cover an area twice or three times greater than its predecessors.

Currently, this technology is being used in combination with others to provide rural broadband in remote locations. WiMAX and WiFi may well become complementary technologies in many cases. The configuration would be to use WiMAX as the backhaul and WiFi as a distribution technology for short distances.

WiMAX and LTE are 4G technologies that together provide more robust links than WiFi and 3G, allowing faster speeds, more stability during movement and better access in difficult areas where there may be a lot of bouncing or wave reflections. WiFi and WiMAX are therefore not comparable technologies.

#### **4. *Satellite broadband***

Satellite links are used to serve remote or sparsely populated areas that are difficult to access via terrestrial resources.

Satellite systems have several technical features which, in some cases, allow them to cope more successfully with certain types of problems associated with broadband technology, for example, latency or lag in transmission, which can pose a major challenge for the use of interactive applications such as VoIP.

Various factors influence the uplink and downlink data transmission rates for satellite broadband, including the provider's system, the line of sight between the end user and the satellite, and weather conditions. While download and upload speeds are on the order of 1 Gbps and 10 Mbps, respectively, in practice average speeds are 1 Mbps downlink and 256 kbps uplink.

## **5. Other wireless technologies**

### *Ultra wideband (UWB)*

This technology emerged almost four decades ago in the military. Today it is seen as a technology that enables very high data rates over short distances and within small enclosures. UWB provides a bandwidth of between 100 and 200 Mbps and is thought to reach fairly stable speeds of 450 Mbps due to its short range, which limits the number of clients that can use the system simultaneously, as is also the case of mobile services with a greater reach.

The distance that can be covered is on the order of the reach of bluetooth (10 m) due to the restrictions set by regulatory agencies, including the United States Federal Communications Commission (FCC). Transmission is performed by sending very low-power pulses at an extremely high frequency, so a very large bandwidth is needed (around 500 MHz).

### *LMDS (Local Multipoint Distribution Service)*

LMDS technology can meet video, data and voice needs. It can achieve high data transmission rates over short distances because it works with very high frequencies (Ka Banda, in the vicinity of 28 GHz). In some countries, because the link is seriously affected by rain, it has been used at lower frequencies. With the emergence of newer technologies such as WiMAX, it has lost ground.

### *Femtocells*

Femtocells are small cellular base stations for indoor use that connect to fixed broadband via xDSL or cable modems (“femto” is a prefix denoting a factor of  $10^{-15}$ ). It is used to route mobile phone communications. In April 2009, 3GPP published its specifications for femtocells in the Universal Mobile Telecommunications System (UMTS). Its deployment is expected to gain momentum thanks to a simplified architecture and the re-use of familiar protocols.

There are two reasons for using femtocells: the saving realized in relation to external base stations systems, with consequent reductions in price and cost; and improved indoor coverage without increasing investment in base stations. Although deployment is still limited, femtocells will be massively deployed with the launch of LTE in the United States and around the world

## Bibliography

- Anderson, Chris (2004), “The Long Tail,” *Wired*, October.
- Anderson, Chris (2010), “The Web is dead. Long Live the Internet. Who is to Blame: Us,” *Wired*, September.
- Anderson, Janna and Lee Rainie (2010a), *Internet evolution: Where hyperconnectivity and ambient intimacy take us*, [presentation] WorldFuture 2010, Pew Research Center’s Internet & American Life Project, Boston, July 7.
- (2010b), *Millennials will make online sharing in networks a lifelong habit*, series The Future of the Internet, Pew Research Center’s Internet & American Life Project, Washington, D.C., July.
- (2010c), “The future of cloud computing,” *The Future of the Internet*, Pew Research Center’s Internet & American Life Project, Washington D.C., June.
- BBC (2010), “Finland makes broadband a ‘legal right,’” *BBC*, July 1, [online], <<http://www.bbc.co.uk/news/10461048>>
- ECLAC (2008), *La transformación productiva 20 años después. Viejos problemas, nuevas oportunidades*, ECLAC, Santiago de Chile.
- (2010), *Las TIC para el crecimiento y la igualdad*, ECLAC, Santiago, Chile.
- Cimoli, Mario, Giovanni Dosi y Joseph E. Stiglitz, (Editors) (2009), *Industrial Policy and Development. The Political Economy of Capabilities Accumulation*. Oxford University Press.
- CISCO (2010), *Hypertextuality and the Approaching Zettabyte Era*, CISCO, San Jose, California.
- Echeberria, Raúl (2010), *Desarrollo de infraestructura e interconexión regional*, Latin American and Caribbean Internet Addresses Registry (LACNIC), Montevideo.
- Federal Communications Commission (2009), “Is broadband a general purpose technology?,” *Notes*, September 28 [online], <[http://www.facebook.com/note.php?note\\_id=141038966044](http://www.facebook.com/note.php?note_id=141038966044)> [Retrieved on: July 31, 2010].
- Fundación Telefónica (2008), *La generación interactiva en Iberoamérica*, Fundación Telefónica, Madrid.
- Helpman, Elhanan y Manuel Trajtenberg (1998) “A time to sow and a time to reap: growth based on general purpose technologies,” *General Purpose Technologies and Economic Growth*, Massachusetts Institute of Technology, Cambridge, Massachusetts.
- Jordán, Valeria, Wilson Peres y Fernando Rojas (2010), *Banda ancha: una urgencia para América Latina y el Caribe*, L.C/R.2158, Production, Productivity and Management Division, ECLAC, Santiago de Chile.
- León, Omar de (2009), *Perspectivas de las tecnologías de telecomunicaciones y sus implicancias en los mercados y marcos regulatorios en los países de América Latina y el Caribe*, Production, Productivity and Management Division, ECLAC, Santiago de Chile.
- (2010), *Panorama de la banda ancha en América Latina, 2010*, Production, Productivity and Management Division, ECLAC, Santiago de Chile.
- Mell, Peter and Tim Grance (2009), “Definition of Cloud Computing,” Cloud Computing Forum and Workshop (May 20, 2010) National Institute of Standards and Technology, United States Department of Commerce, Gaithersburg, Maryland.
- OECD (2004), *Towards high-performing health systems*, Health Project Summary Report, OECD, Paris.
- (2008), *Broadband growth and policies in OECD countries*, Ministerial Meeting on The Future of the Internet Economy (June 17-18, 2008, Seoul), OECD, Paris.

- \_\_\_\_\_ (2009), *Network developments in support of innovation and user needs*, DSTI/ICCP/CISP (2009)2/FINAL, Working Party on Communication Infrastructures and Services Policy, OECD, Paris.
- Peres, Wilson and Martin Hilbert (2009) *La sociedad de la información en América Latina y el Caribe, desarrollo de las tecnologías y tecnologías para el desarrollo*, ECLAC Books, ECLAC, Santiago de Chile.
- Rosenberg, Nathan and Manuel Trajtenberg (2001), "A general purpose technology at work: The Corliss Steam engine in the late 19th century United States," Working Paper Series, Vol. w8485, National Bureau of Economic Research, Cambridge, Massachusetts. [online] <<http://www.nber.org/papers/w8485>>.
- Stross, Randall (2010), "YouTube Wants You to Sit and Stay Awhile," *New York Times*, May 28, [online]. <[http://www.nytimes.com/2010/05/30/business/30digi.html?\\_r=1](http://www.nytimes.com/2010/05/30/business/30digi.html?_r=1)>, [Retrieved on: August 5, 2010].
- The Economist (2010), "Information technology in transition: The end of Wintel," *The Economist*, July 29, [online] <<http://www.economist.com/node/16693547>>, [Retrieved on: August 5, 2010].
- \_\_\_\_\_ (2009), "Clash of the clouds," October 15, [online], <<http://www.economist.com/node/14637206>>, [Retrieved on: July 30, 2010]
- ITU, Broadband Commission (2010), "What Broadband Brings," [online] <<http://www.broadbandcommission.org/whatbroadbandbrings.html>> [Retrieved on: August 2, 2010].
- ITU, International Telecommunications Union (2010a), *Measuring the Information Society 2010*, ITU, Geneva.
- ITU, International Telecommunications Union (2010b), "Key Global Telecom Indicators for the World Telecommunication Service Sector," [online] <[http://www.itu.int/ITU-D/ict/statistics/at\\_glance/KeyTelecom.html](http://www.itu.int/ITU-D/ict/statistics/at_glance/KeyTelecom.html)> [Retrieved on: August 4, 2010].
- Wikipedia (2010) "Web semantics," [online]. <[http://es.wikipedia.org/wiki/Web\\_Sem%C3%A1ntica#cite\\_note-1](http://es.wikipedia.org/wiki/Web_Sem%C3%A1ntica#cite_note-1)> [Retrieved on: August 11, 2010].
- Wikipedia (2010) "Visual networking," [online] <[http://en.wikipedia.org/wiki/Visual\\_networking](http://en.wikipedia.org/wiki/Visual_networking)> [Retrieved on: July 31, 2010].
- Wikipedia (2010) "Cloud computing," [online] <[http://en.wikipedia.org/wiki/Cloud\\_computing](http://en.wikipedia.org/wiki/Cloud_computing)> [Retrieved on: July 31, 2010].
- Wolff, Michael (2010), "The Web is dead. Long Live the Internet. Who is to Blame: Them," *Wired*, September.
- Worden, Nat (2010) "Time Warner Cable CEO: Cable Prices Not Too High," Dow Jones Newswires, June 4, [online] <http://www.nasdaq.com/aspx/company-news-story.aspx?storyid=201006041002dowjonesdjonline000544&title=time-warner-cable-ceo-cable-prices-not-too-high>, [Retrieved on: August 9, 2010].





## II. The contribution of broadband to economic development

Raúl L. Katz<sup>1</sup>

### A. Introduction

Although the spread of broadband is a fairly recent phenomenon, its possible social and economic effects have already attracted the interest of researchers. Interest in the analysis of these effects has increased further in recent years, as many governments in both developed and emerging countries are implementing policies designed to increase broadband deployment. National plans, digital agendas and broadband universalization policies are all guided by the belief that broadband can contribute to economic growth, increased productivity, job creation and social inclusion.

In this chapter, evidence provided by research on the economic impact of broadband in Latin America and developed countries will be examined. The first section presents research results regarding the economic impact of broadband in developed countries, covering areas ranging from its contribution to GDP growth to job creation through increased productivity gains. The second section presents research findings regarding Latin America and focuses primarily on broadband's contribution to economic growth in terms of GDP and job creation.

---

<sup>1</sup> The author gratefully acknowledges Dr. Antonio Botelho, DIRSI Brazil, as well as Javier Avila, Giacomo Mielle and Julian Katz-Samuels, analysts at the Columbia Institute for Tele-Information, for their collaboration in preparing this study.

## B. The impact of broadband on economic growth

Broadband contributes to economic growth initially by producing a series of effects similar to those generated by infrastructure deployment. Beyond the benefits for GDP growth, it also has significant economic effects on consumer surplus (see figure II.1).

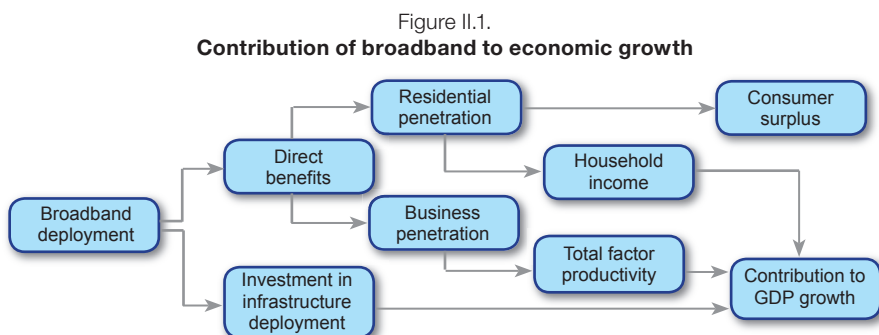

Source: Prepared by the author.

Some of these effects —such as the impact of investment on infrastructure— have been estimated quantitatively through input-output analyses. Others, such as the impact on productivity growth and the elasticity of supply, as well as the multipliers of household income, have not yet been studied in detail. However, beyond this chain of causality, research in developed countries has begun to generate evidence of causality between broadband and growth, as well as the microeconomic effects it can have on business productivity. The next section presents the results of the research conducted to date in these areas.

### 1. The effect on economic growth

Research pertaining to broadband's contribution to GDP growth in developed countries indicates that it is having a positive impact, although the magnitude of that impact varies substantially. The analyses conducted to date have been limited by the availability of information and have therefore focused mainly on the countries of the Organisation for Economic Co-operation and Development (OECD) and, in particular, on the United States.

Using data from OECD countries, two studies have evaluated the impact of broadband on GDP growth. The first (Czernich et al., 2009) analysed this impact in 25 OECD countries between 1996 and 2007. The authors determined

that the adoption of broadband was statistically significant in regard to the rise in per capita GDP, with a ratio of 1.9% to 2.5%.<sup>2</sup> Koutroumpis (2009) tried to solve the underlying problem of endogeneity between variables by constructing simultaneous equations. His analysis focused on 22 OECD countries over the period 2002-2007. Again, the results indicated that there is a statistically significant relationship, with a 1% increase in broadband penetration leading to a 0.025% increase in the GDP growth rate. The author also determined that broadband's contribution to GDP growth increases with its diffusion due to network effects: in countries with low penetration rates (less than 20%), a 1% increase in broadband adoption contributes 0.008% to GDP growth; in countries with an average degree of penetration (between 20% and 30%), the effect is 0.014%; while in countries with high penetration rates (over 30%), the impact on GDP growth rate is 0.023% for every 1% increase in broadband adoption (see figure II.2).

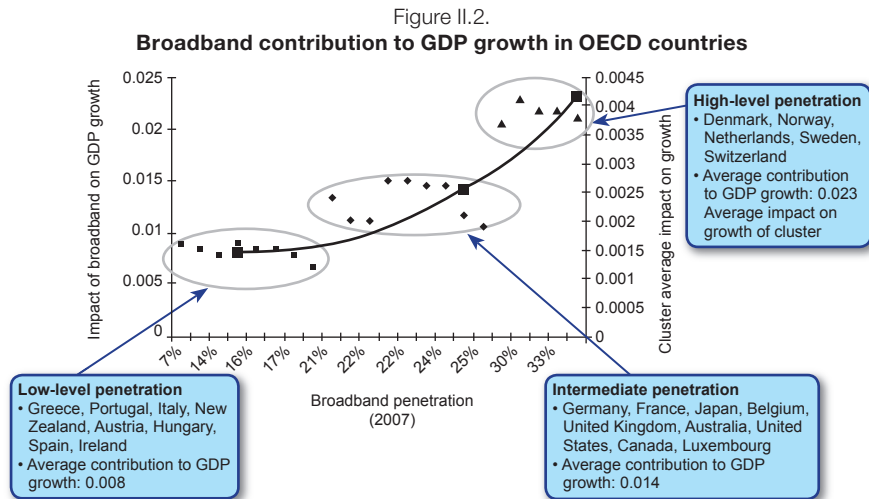

Source: Adapted from Koutroumpis (2009).

A year later, Katz et al. (2010a) calculated the extent of the contribution that Germany's national broadband plan could have on the country's GDP growth. The estimate was based on a statistical analysis of the impact of broadband on economic growth of the German counties (landkreise) between 2000 and 2006. Based on 424 observations, controlling for population growth

<sup>2</sup> To resolve problems of endogeneity (for example, controlling for the effect of the larger investments in broadband made by more advanced countries compared to less developed countries), the study's authors used instrumental variables for broadband penetration, tele-density and cable television infrastructure.

and the starting point for economic development, and using a Hedrick-Prescott filter to control for cyclical effects, the authors determined that a 1% increase in broadband penetration contributes 0.0255% to GDP growth. This result coincides with Koutroumpis' estimate (2009) and, at the same time, validates the existence of an incremental impact of broadband penetration. For the counties with an average broadband penetration of 24.8%, the contribution to GDP growth was around 0.0238%, while, for those with an average penetration of 31%, broadband contributed 0.0256% to GDP (see table II.1).

Table II.1.  
**Germany: the contribution of broadband to GDP growth**

Dependent variable: GDP growth between 2003 and 2006						
G_GDP (03-06) = 1 * GDP_Capita_2000 + 2 * G_POP (00-06) + 3 * G_BBPEN (02-03)						
	Total		Low penetration		High penetration	
Per capita GDP: 2000 (* 1.000.000)	0.0261 (0.041)		0.0627 (0.121)		0.0185 (0.050)	
Population growth (2000-2006)	0.6318 (0.075)	***	0.5311 (0.102)	***	0.7731 (0.116)	***
Broadband penetration growth (2002-2003)	0.0255 (0.002)	***	0.0238 (0.005)	***	0.0256 (0.003)	***
R <sup>2</sup> adjusted	0.6317		0.6321		0.6305	
Number of observations	424		210		214	

Source: Katz et al., 2010a.

Note: \*\*\* indicates the statistical significance at a 1% level. Standard errors indicated in brackets.

In addition to studies of OECD countries, there are two studies on broadband's contribution to GDP growth in the United States. Crandall et al. (2007) examined the effect of broadband penetration on GDP in 48 states within the United States over the period 2003-2005. In this case, the model used to measure the impact on the GDP of the non-agricultural private sector did not generate significant results.<sup>3</sup> The authors concluded that this was due to errors in GDP estimates for the individual states. A year later, Thompson et al. (2008) attempted to measure the indirect impact of broadband on GDP in 46 states over 2001-2005.<sup>4</sup> Using Battese's and Coelli's stochastic production function (1995) to estimate a production function and inefficiency model simultaneously, the authors determined that broadband has a significant impact on production: a 10% increase in penetration is linked to a 3.6% increase in efficiency.

<sup>3</sup> The only significant coefficient was the dummy for the mountainous western region of the United States.

<sup>4</sup> The authors did not analyse other series due to a lack of data.

In the only cross-sample analysis that includes data from developed and emerging countries, Qiang et al. (2009) applied the Waverman model (2005) to measure endogenous technological change between GDP and broadband historical series. The results revealed a trend opposite to that identified by Koutroumpis (2009) and Katz et al. (2010a). For most developed countries (and, as such, countries with higher broadband penetration rates), every 1% increase in penetration leads to an increase of 0.121% in GDP, whereas, in *low- and middle-income developing economies*, a 1% increase in broadband penetration generated 0.138% in economic growth.<sup>5</sup> The magnitude of broadband's contribution to GDP growth is much higher in the study conducted by Qiang et al. (2009) than is indicated by earlier studies (see table II.2).

Table II.2.  
Research results regarding the impact of broadband on GDP growth

Country/Region	Study	Data	Impact
United States	Crandall et al. (2007)	48 states in the United States, 2003-2005	No statistically significant impact on GDP growth
	Thompson et al. (2008)	46 states in the United States, 2001-2005	A 10% increase in broadband penetration was linked to a 3.6% increase in efficiency
OECD	Czernich et al. (2009)	25 OECD countries, 1996-2007	Broadband adoption elevated per capita GDP by between 1.9 % and 2.5%
	Koutroumpis (2009)	22 OECD countries, 2002-2007	A 10% increase in broadband penetration produced a 0.25% increase in GDP growth
Germany	Katz et al. (2010a)	424 counties in Germany, 2000-2006	A 10% increase in broadband penetration produced a 0.255% increase in GDP growth
Developed countries	Qiang et al. (2009)	Developed countries from a sampling of 120 countries, 1980-2002	A 10% increase in broadband penetration produced a 1.21% increase in GDP growth
Low- and middle-income countries	Qiang et al. (2009)	Remaining countries (low- and middle-income developing economies) from a sampling of 120 countries, 1980-2002	A 10% increase in broadband penetration contributed 1.38% to economic growth

Source: Prepared by the author.

As illustrated in table II.2, with the exception of one study, all of the research regarding the impact of broadband on GDP growth concludes that there is a positive effect. However, the impact varies between 0.025% and 0.138% for each 1% increment in penetration.<sup>6</sup> The reasons for this difference are manifold. Clearly, part of the variance can be explained by the use of different databases, as well as different model specifications. However, this point aside, it is important to note the methodological limitations of some econometric models. First, when working with highly aggregated data (for example country-level series), it is impossible to understand the wide divergence of effects between

<sup>5</sup> The coefficient associated with low- and middle-income developing countries was not statistically significant.

<sup>6</sup> Assuming a 1% increase in productivity or efficiency leads to a 1% increase of GDP, then the total effect on GDP could be 3.6% (Thompson et al, 2008).

regions, which tends to be explained by fixed effects (see Katz et al., 2010a). As a result, in the case study of Qiang et al. (2009), much of the variance is explained by dummy variables for Africa and Latin America (nearly 10 times more than the estimates provided by Barro (1991) in the original formulation of his model of economic growth). This suggests that the most appropriate method of analysis is the differentiation of fixed effects. The difference in results also indicates the need to break down country data by working at lower levels of aggregation, such as provinces, states, counties or postal codes. Obviously, the availability of information on the relationship between broadband and economic performance is much more limited. The only studies in developed countries with a breakdown of broadband's impact on economic growth are Thompson et al. (2008), Crandall et al. (2007) and Katz et al. (2010a).<sup>7</sup>

Second, studies should address the methodological issue of reverse causality. Assuming that the demand for broadband is determined in part by price elasticity, then economic growth and increased broadband penetration would be linked by a bilateral effect. However, of the various studies that have addressed this methodological problem, only those of Katz et al. (2010a) and Koutroumpis (2009) have produced positive results.<sup>8</sup>

## **2. Job creation**

Beyond the impact of broadband adoption on economic growth, numerous studies have focused on its impact on job creation. This impact can be split into two types of effects: jobs generated by the initial deployment of infrastructure; and employment resulting from network effects and their spillover into other areas of the economy. The next section explores these two impacts.

### *Job creation stemming from the building of broadband networks*

The construction of broadband networks has three effects on job creation. First, network deployment entails direct job creation, since people such as telecommunications technicians, construction workers and equipment manufacturing operators are needed to install these networks. Second, direct job creation leads to indirect job creation in, for example, metallurgical and electrical product industries that supply the industries directly involved. Finally, household spending resulting from direct and indirect job creation leads to induced employment.

---

<sup>7</sup> Section 3 presents a study with a comparable level of disaggregation for Chile.

<sup>8</sup> Katz et al. (2010a) address the issue through lagging historical series, while Koutroumpis (2009) uses a system of simultaneous equations.

Direct, indirect and induced employment resulting from the construction of broadband networks can be calculated using an input-output analysis. The interrelationship of these three effects is measured by means of multipliers, which estimate the total change in employment in an economy as a result of a unit increase in inputs.

There are six studies that estimate the impact of broadband network construction on employment: Crandall et al. (2003), Katz et al. (2008), Atkinson et al. (2009), Katz et al. (2009a), Liebenau et al. (2009) and Katz et al. (2010a). All of these studies estimate the number of jobs created as a result of capital investments in the deployment of broadband networks: US\$ 63 billion required to roll out broadband services throughout the United States (Crandall et al., 2003); CHF 13 billion to build a national fibre optic network in Switzerland (Katz, 2008); US\$ 10 billion (Atkinson, 2009) and US\$ 6.3 billion (Katz et al., 2009a) as part of stimulus packages in the United States (Katz et al., 2009a); US\$ 7.5 billion to complete the deployment of broadband in the United Kingdom (Liebenau et al, 2009); and US\$ 47 billion to implement the National Broadband Plan in Germany (Katz et al., 2010a).

Crandall et al. (2003) undertook a study for the New Millennium Research Council using an input-output analysis to estimate the impact that a programme to deploy broadband in United States households could have on employment. Based on a capital investment budget designed to attain a 95% household penetration rate (up from 60%), the authors estimated the number of jobs that would be created in the manufacturing of telecommunications equipment and the multiplier effect in consumption resulting from the increased income. Applying multipliers calculated by the Bureau of Economic Analysis of the United States, the authors estimated that a US\$ 63.6 billion capital investment in the construction of broadband networks would create 61,000 jobs per year. On the other hand, if the investment were allocated to next-generation broadband platforms such as VDSL and FTTx, the cumulative effect would be 140,000 jobs per year. The increased consumption resulting from universal broadband adoption would in turn create 665,000 jobs, which, added to the 546,000 that would be created by network construction, totals 1.2 million jobs.

Similarly, Atkinson et al. (2009) also used an input-output analysis from the Bureau of Economic Analysis of the United States to estimate the impact on job creation of an investment of US\$ 10 billion in broadband access deployment. The authors concluded that this investment would directly create 64,000 jobs and result in 166,000 indirect and induced jobs.

Katz et al. (2009a) also estimated the effect on job creation of the construction of a broadband system, but, in this case, they calculated the

effect of an investment of US\$ 6.39 billion, a figure based on the contribution earmarked for broadband in the Obama Administration's stimulus programme, the American Recovery and Reinvestment Act of February 2009. Again using an input-output analysis to estimate direct, indirect and induced employment, the authors estimated that the investment would generate 127,000 jobs per year over the four years that it would take to build networks covering households in rural areas. Of these jobs, 37,283 would be direct and 31,098 would be indirect. A breakdown by industrial sector is presented in table II.3.

Table II.3.

**United States: estimated direct and indirect job creation per year as a result of the implementation of the broadband stimulus programme**

	Sectors	Jobs
Direct jobs	Electronic equipment	4,242
	Construction	26,218
	Communications	6,823
	Total direct jobs	37,283
Indirect jobs	Distribution	9,167
	Other services	8,841
	Transport	1,536
	Electronic engineering	959
	Metallurgical products	1,839
	Others	8,704
	Total indirect jobs	31,046
<b>Total jobs</b>		<b>68,329</b>

Source: Katz et al. (2009a).

Once direct and indirect job creation had been estimated, induced job creation was calculated. In this case, induced job creation resulted in an additional 59,500 jobs. Adding up the three effects, the resulting figure is 127,800, or 31,950 jobs per year. The resulting multipliers are consistent with those estimated by the other two studies carried out for the United States (see table II.4).

Table II.4.

**United States: compared investment multipliers**

		Katz et al. (2009a)	Atkinson et al.(2009)	Crandall et al.(2003)	
Estimated investment (in millions of US dollars)		6,390	10,000	63,600	
Jobs	Direct	Jobs in equipment manufacturing, construction and telecommunications	37,300	63,660	546,000
	Indirect	Jobs created through direct expenditures	31,000		
	Induced	Jobs created through direct and indirect expenditures	59,500	165,815	665,000
	Total	Types I and II	127,800	229,475	1,211,000
Multipliers	Type I	(Direct+indirect)/direct	1.83		
	Type II	(Direct+indirect+induced)/direct	3.42	3.60	2.17

Source: Katz et al. (2009a).

Taking a similar approach to the one used in the research conducted in the United States, three studies have been carried out to estimate the effect of



broadband deployment in European countries. Katz et al. (2008) studied the impact of a CHF 13 billion investment to build a national fibre optic network in Switzerland. Using Eurostat data for input-output analysis, the study estimated that the deployment of such a network would generate 114,000 jobs per year: 83,000 direct jobs and 31,000 indirect jobs.<sup>9</sup>

Likewise, Katz et al. (2010a) estimated the impact that the implementation of the National Broadband Plan in Germany would have on employment. After estimating that the implementation of this plan would require 35.9 billion euros, based on an input-output analysis carried out by Germany's Federal Statistical Office, it concluded that the construction of broadband networks would result in the creation of 304,000 jobs (over 60,000 jobs per year) between 2010 and 2014 and 237,000 jobs per year (almost 40,000 jobs per year) between 2015 and 2020 (see table II.5).

Table II.5.  
**Germany: total effect of broadband construction on employment**  
(Jobs/year)

Type of impact	2014: National broadband strategy	2020: Development of ultra-broadband	Total
Direct jobs	158,000	123,000	281,000
Indirect jobs	71,000	55,000	126,000
Induced jobs	75,000	59,000	134,000
Total	304,000	237,000	541,000
Multiplier type I	1.45	1.45	
Multiplier type II	1.92	1.93	

Source: Katz et al. (2010a).

The impact, by industry, of direct and indirect effects in Germany is shown in table II.6:

Table II.6.  
**Germany: sector-based impact of direct and indirect job creation**  
(Jobs/year)

	2014: National broadband strategy	2020: Development of ultra-broadband	Total
Construction	125,000	99,000	224,000
Telecommunications	28,400	21,000	49,400
Other services	17,000	13,000	30,000
Distribution	10,700	8,400	19,100
Metallurgy	4,800	3,700	8,500
Electronic equipment	4,700	3,400	8,100
Electrical equipment	3,200	2,500	5,700
Financial services	3,000	2,000	5,000
Other	32,200	25,000	57,200
Total	229,000	178,000	407,000

Source: Katz et al. (2010a).

<sup>9</sup> The study did not estimate induced job creation.

Finally, Liebenau et al. (2009) calculated the impact on employment of the implementation of the Digital Britain plan in the United Kingdom. According to this study, the US\$ 7.5 billion investment required to implement the programme would result in the creation of 211,000 jobs (76,500 directly and 134,500 indirectly or induced).

In summary, these studies estimate the amount of investment needed to deploy broadband and the total amount allocated by industry and then estimate the impact on industrial sector output and job creation sources based on the calculation of multipliers. The results of the six studies all indicate that broadband network construction has a positive impact on employment (see table II.7).

Table II.7.  
**Job creation for broadband deployment**

Country	Authors	Objective	Result
United States	Crandall et al. (2003)	Estimate the impact on employment of a US\$ 63.6 billion investment in broadband deployment to increase the household penetration rate from 60% to 95%	<ul style="list-style-type: none"> <li>• Create 140,000 new jobs per year</li> <li>• Total jobs: 1.2 million (including 546,000 in construction and 665,000 indirect)</li> </ul>
	Katz et al. (2009a)	Estimate the impact of a US\$ 6.3 billion investment made as part of a federal government stimulus package for employment	<ul style="list-style-type: none"> <li>• Total jobs: 128,000 (including 37,000 direct, 31,000 indirect and 60,000 induced)</li> </ul>
	Atkinson et al. (2009)	Estimate the impact of a US\$ 10 billion investment in broadband deployment	<ul style="list-style-type: none"> <li>• Total jobs: 180,000 (64,000 direct and 116,000 indirect and induced)</li> </ul>
Switzerland	Katz et al. (2008)	Estimate the impact of the deployment of a national fibre optics network requiring an investment of CHF 13 billion	<ul style="list-style-type: none"> <li>• Total jobs: 114,000 (83,000 direct and 31,000 indirect)</li> </ul>
Germany	Katz et al. (2010a)	Estimate the impact of the US\$ 47 billion investment required to implement the National Broadband Plan	<ul style="list-style-type: none"> <li>• Total jobs: 542,000 (including 281,000 direct, 126,000 indirect and 135,000 induced)</li> </ul>
United Kingdom	Liebenau et al. (2009)	Estimate the impact of a US\$ 7.5 billion investment in the Digital Britain plan	<ul style="list-style-type: none"> <li>• Total jobs: 211,000 (including 76,500 direct and 134,500 indirect and induced)</li> </ul>

Source: Prepared by the author.

Based on input-output analyses, all the studies calculated the multipliers that measure the creation of job sources in the production system based on broadband construction. The Type I multiplier (direct employment + indirect employment / direct employment) measures the relationship between the sectors directly involved in broadband deployment (for example, telecommunications, construction and engineering) and the sectors that are direct suppliers for those sectors (for example, metallurgy, commerce, transportation and professional services). The Type II multiplier (direct employment + indirect employment + induced employment / direct employment) measures the relationship between the sectors involved directly, those affected indirectly and the effects of induced consumption. The estimation of multipliers is relatively consistent across the different studies (see table II.8).

Table II.8.

**Compared multiplier effects of broadband network construction**

Country	Authors	Type I	Type II
United States	Crandall et al. (2003)	n.d.	2.17
	Katz et al. (2009a)	1.83	3.42
	Atkinson et al. (2009)	n.d.	3.60
Switzerland	Katz et al. (2008)	1.38	n.d.
Germany	Katz et al. (2010)	1.45	1.94
United Kingdom	Libenau et al. (2009)	n.d.	2.76

Source: Prepared by the author.

Note: Crandall et al. (2003) and Atkinson et al. (2009) do not differentiate between indirect and induced effects, and the type I multipliers can therefore not be calculated for these studies; Katz et al. (2008) does not calculate type II multipliers because the induced effects were not estimated.

According to these findings, by creating jobs in broadband network construction, between 0.8 and 0.3 additional jobs could be indirectly generated; this number rises to as much as 2.60 when both indirect and induced job creation is taken into consideration. While the multipliers cannot be extrapolated from one economy to another—due to the fact that they reflect specific inter-sectoral relationships—their comparison is a useful means of visualizing the effects in different countries.

### *Job creation as a result of externalities*

Beyond job creation as a result of the construction of broadband networks, the impact of externalities on employment, referred to as “innovation” or “network effects” (Atkinson et al. 2009), have been studied. By looking at the externalities resulting from the adoption of broadband, numerous effects have been identified:

- Introduction of new services and applications, such as tele-medicine, Internet information searches, e-commerce, distance education and social networks (Atkinson et al., 2009)
- New forms of trade and financial intermediation (Atkinson et al., 2009)
- Development of new products and services (Atkinson et al., 2009)
- Improved productivity as a result of the introduction of more efficient business processes through the use of broadband, and marketing of excess inventories and supply chain optimization<sup>10</sup> (Atkinson et al., 2009)

<sup>10</sup> Efficient telecommunications make it possible to reach a broader market, facilitating business processes. They also result in reduced input costs as the capacity to search for lower prices increases.

- Revenue growth resulting from extended market coverage (Varian et al., 2002, and Gillett et al., 2006)
- Growth of industries within the services sector (Crandall et al., 2007)
- Impact on the composition and deployment of industrial value chains. Broadband can attract jobs from other regions by making it possible to process information and provide services remotely. The services that feel the greatest impact of this type are outsourcing and the deployment of virtual customer service centres.

Job creation resulting from externalities has been calculated based on econometric analyses of historical data series, which have yielded significant findings about the network effects involved. These studies have been carried out mainly in the United States, although one was conducted in Germany. Table II.9 presents the econometric studies that were used to estimate the impact of the positive externalities of broadband on job creation.

Table II.9.  
Impact of positive broadband externalities on employment

Country	Authors	Data	Effect
Germany	Katz et al. (2010a)	German counties, 2000-2006	A 1% increase in broadband penetration makes a 0.002% contribution to employment growth
	Gillett et al. (2006)	United States postal code areas, 1998-2002	Availability of broadband access increases employment growth by between 1% and 0.5%
	Crandall et al. (2007)	48 states in the United States	For every 1% increase in broadband penetration in each state, employment would increase by an estimated 0.2% - 0.3% per year, assuming that the economy is not at full employment
United States	Thompson et al. (2008)	48 states in the United States, 2000-2006	Job creation varied by industry
	Shideler et al. (2007)	Counties (disaggregated data) in the state of Kentucky for 2003-2004	A 1% increase in broadband penetration made a contribution of between 0.14% and 5.32% to employment growth, depending on the industry
State of California (United States)	Kolko (2010)	California postal code areas, 1999-2006	The study did not find a significant relationship, in part because broadband service is measured based on the number of operators per postal code

Source: Prepared by the author.

According to these studies, once broadband is deployed, its contribution to employment growth ranges from 0.14% to 5.32%, depending on the territory and the industrial sector concerned. More precisely, a 1% increase in broadband penetration contributes between 0.002% and 0.5% to employment growth.

Beyond the aggregate impact on job creation, studies conducted by Crandall et al. (2007), Thompson et al. (2009), Katz et al. (2009a), Gillett et al. (2005) and Shideler et al. (2007) show that the effect on job creation tends to vary by region and industry (see table II.10).

Table II.10.  
**The effect on job creation, by region or sector**

Country	Authors	Effects
Germany	Katz et al. (2010a)	A 1% increase in broadband penetration contributes between 0.006% and 0.003% to employment growth, depending on the region
	Gillett et al. (2006)	The relationship between broadband penetration and employment is not linear because technology is adopted first by those sectors that obtain the greatest benefits, followed by those that obtain a lesser benefit
United States	Crandall et al. (2007)	The impact of broadband is greater for the services sector, although there is also an impact in manufacturing
	Thompson et al. (2009)	The impact on job creation varies by industrial sector, with the greatest impact being seen in the financial and services sectors
State of Kentucky (United States)	Shideler et al. (2007)	The impact of broadband on tourism is negative and significant (0.34%), which suggests that broadband deployment could substitute technology for jobs in this industry

Source: Prepared by the author.

The study regarding the German market demonstrates that the impact on job creation varies by region and illustrates this by breaking down the country into counties with high broadband penetration (31%, on average, in 2008) and low penetration (24.8%, on average, in 2008). In counties with high broadband penetration, once penetration increases, the effect on job creation is significant in the short term but fades in the long term. On the other hand, in counties with low broadband penetration, the increase in broadband deployment has a negative impact on job creation (in other words, a reduction in the number of jobs) in the short term but has a positive effect in the long term. A comparison of these effects is presented in figure II.3.

Figure II.3.  
**The regional effect of broadband on job creation, by level of penetration**

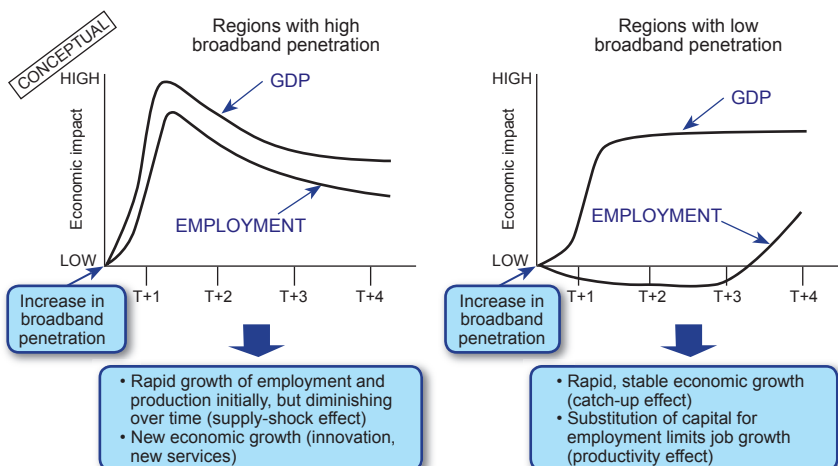

Source: Prepared by the author.

These different effects can be explained by the fact that increased broadband deployment in more advanced regions creates a supply shock in companies that can leverage technology to generate new business and increase efficiency. In contrast, in regions with lower broadband adoption, the increase in penetration leads to substitution between capital and labour, whereby the productivity gains generated by broadband use produce a decline in employment.<sup>11</sup> In the medium term, the increase in broadband adoption has a positive impact, which can be explained in terms of the learning process involved in the assimilation of technological inputs and the generation of job-creating innovations. In other words, in those regions that are lagging behind, the effect of network bandwidth is increased productivity in the short term and, as a result, the loss of jobs; in the medium and long terms, the resulting innovation leads to job creation.

Causal analysis of simultaneous effects of opposite signs was formalized by Fornefeld et al. (2008) in a study on broadband and job creation for the European Commission. According to the study, an increase in broadband deployment has three effects on job creation. The first is accelerated innovation as a result of the introduction of applications and services provided by broadband (which leads to job creation); the second effect is improved productivity as a result of the adoption of more efficient business processes (which leads to a reduction in jobs); the third effect is the ability to attract jobs from other regions given the possibility of remotely processing information (which results in an increase in employment). These three effects act simultaneously and therefore have effects of opposite signs on job creation (see figure II.4).

Figura II.4.

#### Causal chain between broadband penetration and job creation

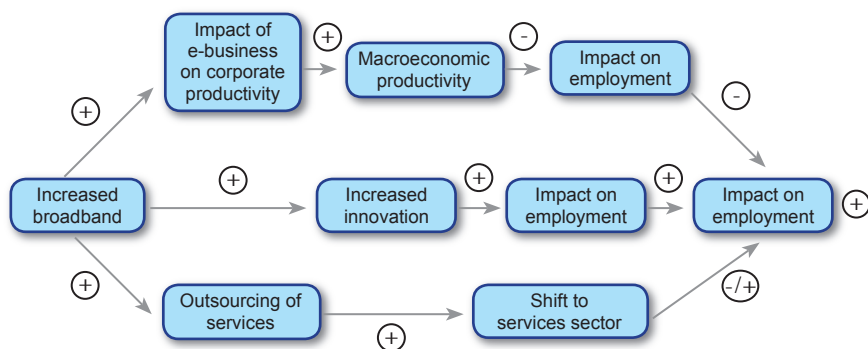

Source: Adapted from a model developed by Fornefeld et al. (2008).

<sup>11</sup> This effect was alluded to by Gillett et al. (2006) when they stated that broadband can facilitate capital-labour substitution, thereby resulting in slower employment growth. Thompson et al. (2008) also mentions that it is possible that a substitution effect between broadband and employment exists.

According to a study by Fornefeld et al. (2008), once the simultaneous effects are quantified, the impact on innovation, combined with the attraction of new businesses due to outsourcing, neutralizes the negative effect of job losses as a result of the initial effect on productivity.

In general, studies based on econometric analysis do not differentiate between the effects of network construction and externalities. However, from an analysis of these studies' findings, it is possible to identify certain impacts on the non-uniformity of spillover effects. This analysis indicates that the job creation resulting from broadband adoption tends to be concentrated in the services sector (for example, financial services and health, among others).

Beyond what can be inferred from the econometric analysis of externality effects on job creation, Pociak (2002) and Atkinson et al. (2009) used a multiplier of network effects, which was then applied to the estimates of the effects of deployment. For example, Pociak used two multiplier estimates (an IT multiplier of 1.5 and 2.0 IT attributed to a United States research centre and a multiplier of 6.7 attributed to Microsoft) and calculated an average of 4.1. Similarly, Atkinson et al. (2009) calculated a multiplier of 1.17 based on the work of Crandall et al. (2003). While this methodology makes it possible to rapidly arrive at an estimate of externalities, it lacks a theoretical foundation. When this methodology is used, the externality effects are not calculated on the basis of inter-sectoral relationships, as is done when using input-output matrices, which allow researchers to estimate the impact of technology on employment and production by industrial sector.

In conclusion, beyond the positive impact on job creation of network construction, the positive externalities of broadband vary according to the region and industry in which it is deployed. Overall, the evidence shows significant positive effects in technologically advanced regions, as well as in the service sector, whereas, in less technologically sophisticated regions, research indicates that broadband deployment initially produces a negative effect, which, however, gives way to a positive impact in the medium term.

### **3. Productivity gains**

Academic research has shown that the productivity of information workers and, thus, economic growth depends directly on ICT capital investments. Studies for Latin America (Katz et al., 2009b) and for industrialized countries (Katz, 2009a) show that the larger the percentage of the workforce engaged in processing or generating information is, the higher the proportion of investment devoted to the acquisition of information technology capital goods will be. Thus, the higher the IT capital investment is as a proportion of total fixed capital investment, the higher labour productivity will be (Katz, 2009b).

Similarly, capital investment in telecommunications is beginning to affect the rate of change in productivity. In a study of economic series in Chile (Katz, 2009b), it was observed that, when the rate of investment in telecommunications grows, two years later the rate of productivity growth increases. In the opposite case, when the rate of investment in telecommunications declines, so does productivity. This means that ICT investment and productivity are inextricably linked. The same relationship was tested in a study on Spain (Katz, 2009c). In addition, ECLAC studies have concluded that ICT capital investment contributed 0.62% to the growth of the Chilean economy between 1990 and 2004 and 0.21% to the growth of Brazil between 1995 and 2004 (de Vries et al., 2007). In the case of the Chilean telecommunications sector, Katz (2009b) shows that a 10% increase in investment can lead to an 2% increase in the productivity growth rate.

What explains this relationship between broadband and productivity? Economic development involves the introduction of complex production processes that require coordination along the various stages of a company's value chain, as well as an efficient supply of components and product distribution. In the early stages of industrial development, the need for coordination and efficiency led to the adoption of certain business processes and the recruitment of workers to process the information needed to coordinate them. However, in the long term, broadband is a platform that allows these workers to increase their efficiency in processing and transmitting information. Without broadband, the productivity of this sector of the workforce would stagnate (see figure II.5).

Figure II.5.

### Causal chain between broadband and productivity

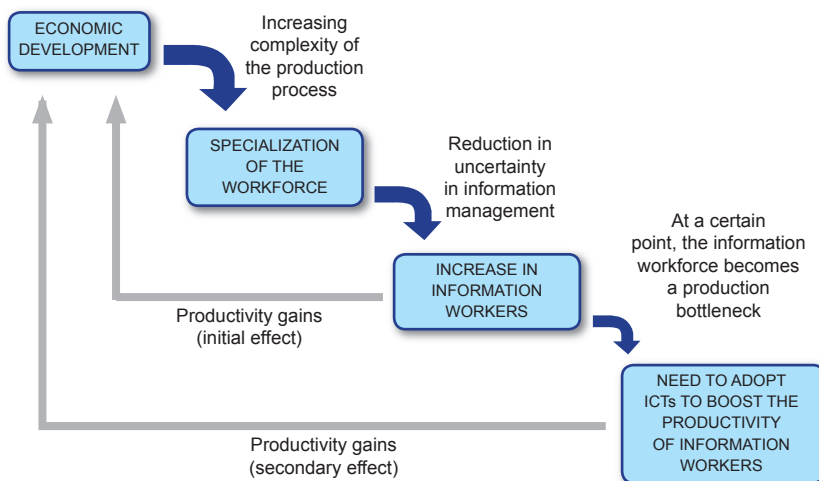

Source: Prepared by the author.



In 2009, Waverman et al. (2009) studied the economic impact of broadband in 14 European countries and the United States using historical series from 1980 to 2007. Based on an augmented production function, derived from Waverman et al. (2005), two models were specified: a production function and a hedonic function for ICT capital stocks. The researchers determined that broadband had an impact on the order of 0.0013 on the productivity of the countries studied. The results were statistically significant at 5%. The original coefficients were 0.0027 for two thirds of the more advanced countries in the sample and negative for the one third of the sample composed of less developed economies. When the authors assumed that the latter would be zero, the coefficient for the entire sample reached 0.0013. In other words, for every 1% increase in broadband penetration, productivity increased by 0.13%. It is important to note the clarification that the authors made in a subsequent presentation of their findings, in which they mentioned that, in countries with relatively low ICT penetration (Greece, Italy, Portugal, Spain and Belgium), the impact of broadband on productivity is zero, which points to high costs of adoption and high thresholds of critical mass. In other words, in order for broadband to influence productivity, the ICT ecosystem must be sufficiently developed so that technology makes a positive contribution. The authors provide an example of this relationship in the United States. In this case, they note that productivity grew at an average of approximately 2% per year between 1999 and 2007, while broadband subscriptions increased by 2.5 lines per inhabitant per year. According to their model, broadband accounted for approximately 0.26% per year of productivity, resulting in an additional US\$ 0.11 per hour worked, or US\$ 29 billion per year.

Numerous studies have analysed the binding causality existing between broadband and productivity on a microeconomic level. For example, Varian et al. (2002) found that the adoption of Internet-based applications allows companies to reduce their costs (by US\$ 155 billion for United States companies and by US\$ 8.3 billion for companies in France, Germany and the United Kingdom). Atrostic and Nguyen (2006), for their part, analysed the productivity of 25,000 manufacturing plants based on data collected by the United States Bureau of the Census. These authors found a correlation of from 3.85% to 6.07% between the intensive use of business processes automated through the introduction of broadband and labour productivity. A similar methodology was applied by Rincon-Aznar, Robinson and Vecchi (2006) at the National Institute of Economics and Social Research in the United Kingdom using a database on companies that employ e-business processes. These authors concluded that 90% of the companies in the services sector improved their productivity by 9.8%, on average, after adopting broadband-based e-business processes. The

study's findings also showed that the improvement in productivity as a result of the introduction of e-business processes is approximately twice as great in the services sector as it is in the financial sector. These results are consistent with the analysis of survey results conducted by e-Business@Watch, which indicate that the degree of improvement in productivity as a result of the introduction of business processes facilitated by broadband depends on the industrial sector concerned.

Obviously, the more information-intensive a company's operations are, the greater the impact of broadband on productivity will be. For example, Fornefeld et al. (2008) estimated that the impact of information on labour can be as high as 20%. The above-mentioned results are summarized in table II.11.

Table II.11.

**Broadband-driven productivity gains**

Economic sector	Study	Impact of e-business on company's productivity	Share of information activities that involve external entities
Manufacturing	Atrostic et al. (2006)	~5%	~25%
Services	Rincón-Aznar et al. (2006)	~10%	~50%
Information	Fornefeld et al. (2008)	~20%	100%

Source: Fornefeld et al. (2008).

Thus, researchers are beginning to use econometric analyses of national variables and microeconomic studies at the company level to explore the causal link between the introduction of broadband and productivity.

#### **4. Impact on innovation**

The impact of broadband on business innovation has been studied primarily at a microeconomic level. Some studies have evaluated the impact of this technology in areas such as increased turnover, the establishment of new businesses and the development of new products and services.

Clarke (2005) has studied the impact of broadband Internet access on exports of industrial and service companies in low- and middle-income developing countries in Eastern Europe and Central Asia. The study controlled for variables such as company size, industrial sector, presence of foreign capital, controlling shareholder, company performance, level of competition in the domestic market, participation in international trade organizations, progress in privatization, and urban population and telecommunications infrastructure. Also, taking precautions with respect to reverse causality, the author found that manufacturing companies with broadband connectivity and Internet access generate 6% more sales than those

of their peers that do not have broadband access. For companies in the services sector, the increase in sales is between 7.5% and 10%.

The impact on the development of products and services is tied to the network effect generated by providing a significant number of households with broadband connections, which facilitates e-commerce and the development of new businesses (e.g., through information searches and advertising). Crandall et al. (2007) have studied this kind of impact on the United States economy and estimate a multiplier of 1.17 from the network effects of a universal broadband service. Liebenau et al. (2009), in a similar study on the British economy, estimated a lower multiplier (0.33) based on lower broadband penetration (40%).

In an estimate used in macroeconomic analysis, Fornefeld et al. (2008) calculated the impact of innovation on European Union economies, distinguishing two types of effects: increased market share for industrial sectors as a result of broadband adoption, and the development of new markets as a result of the launch of new services. To arrive at a quantitative estimate of the impact, the authors assumed that 100% growth in knowledge-based information services can be attributed directly or indirectly to innovation driven by the introduction of broadband. For the rest of the services sector, the authors calculated the ratio of jobs eliminated as a result of productivity gains to the jobs created thanks to innovation in new businesses. This relationship was used to calculate the effect of job creation as a result of innovation. The authors estimated that this effect resulted in the creation of 549,000 jobs in the 27 European Union countries in 2006.

In summary, research at a national level, as well as at the enterprise level, is beginning to demonstrate the impact of broadband on innovation in production processes and new product development.

## **5. Positive externalities in consumption**

The positive externalities of broadband also have been studied in terms of its impact on the consumer surplus, defined as the benefit derived by consumers when acquiring a good at a lower price than they would be willing to pay. The consumer surplus may change as the result of two factors. First, the demand curve can move upward due to a greater penetration of broadband. Second, prices can be reduced as a result of increased productivity or increased competition.

The calculation of the consumer surplus resulting from the penetration of broadband is important inasmuch as this economic benefit does not form part of estimated GDP. Greenstein and McDevitt (2009), in an analysis of

the United States in the period 1999-2006, determined that the consumer surplus generated in 2006 by broadband accounted for US\$ 7.5 billion (or 27% of the total surplus of US\$ 28 billion). This calculation is based on primary information about how much users were willing to pay to use broadband and replace narrowband dialup access.

More recently, these authors estimated the surplus in six countries: Canada, United Kingdom, Spain, Mexico, Brazil and China (Greenstein and McDevitt, 2010). Since the available data were limited, the authors restricted the analysis to price movements, which diminishes the magnitude of the effect. Even so, they calculated a total surplus of US\$ 7.03 billion in 2009 for Brazil, of which 22% is considered to be consumer surplus. In the case of Mexico, the total surplus was US\$ 2.3 billion, while the consumer surplus was 8%. In general terms, they concluded that the overall scale of broadband deployment determines the amount of the total surplus.

Beyond the quantitative estimates, the consumer surplus can be conceptualized in terms of the benefits that broadband provides to users. The variables that influence users' willingness to pay more than the established price represent the user benefits of adopting the technology. In the case of broadband, benefits include obtaining information quickly and efficiently, saving the physical travel time involved in carrying out transactions, and realizing gains in health and entertainment.

### **C. The contribution of broadband to the performance of small and medium-sized enterprises**

Empirical research on the contribution of broadband to the performance of small and medium-sized enterprises (SMEs) is fairly limited. To date, most microeconomic studies on the subject have tended to focus on large and medium-sized enterprises or on the differential impact when it is broken down by industry. On the other hand, studies on the impact of ICTs on SMEs have made no distinction between communications technologies and information systems. Given the importance of this sector in Latin American economies, this effect should be explored. Until such research findings become available, some hypotheses regarding the impact of broadband on this type of economic player can be formulated, while bearing in mind that they will need to be verified empirically.

In theory, broadband should have a strong impact on small and medium-sized enterprises via the network effects arising from their more efficient integration into the production system. For example, when studying

the impact of broadband on the competitive position of companies in the United Kingdom, Clayton et al. (2004) determined that companies that have broadband connections tend to be more fully integrated into their business environment, which allows them to obtain more and better information about their competition and, most importantly, to communicate more efficiently with suppliers and partners. Thus, it is conceivable that broadband adoption by SMEs allows them to access resources which would otherwise be unaffordable because of the company's size or the cost of those resources. Another consideration is that broadband can help to reduce the cost of distributing information, thereby helping SMEs to access new, more efficient production processes and to reduce costs. Broadband can also help them to forge a place for themselves in distribution channels and to cover a wider market.

As for all businesses, ICT is a key production factor for SMEs, regardless of their type of activity. Kotelnikov has defined four stages in the adoption of these technologies by SMEs (see table II.12).

Table II.12.  
Stages of ICT adoption by SMEs

	Basic communications	Basic information technology	Advanced communications	Advanced information technology
Telecommunications	<ul style="list-style-type: none"> <li>• Fixed telephony</li> <li>• Mobile telephony</li> <li>• Fax</li> </ul>		<ul style="list-style-type: none"> <li>• e-mail</li> <li>• Internet access</li> <li>• Videoconferencing</li> <li>• File sharing</li> <li>• e-Commerce</li> <li>• VoIP</li> </ul>	
Information technology		<ul style="list-style-type: none"> <li>• Personal computer equipped with basic software (spreadsheet and word processing)</li> </ul>		<ul style="list-style-type: none"> <li>• Databases</li> <li>• ERP</li> <li>• Inventory management</li> <li>• CRM</li> </ul>

Source: Kotelnikov (2007)

For SMEs, the importance of ICTs, including broadband, varies by type of business. For example, most internationalized SMEs that are integrated into the global economy are highly dependent on proper broadband access. Since this is a non-discretionary factor of production, an international SME cannot access competitive markets without adequate telecommunications support. In order for such a firm to attain a sustainable competitive position, it can be assumed that the level of equipment and service must be equivalent to that of a similar company in a developed economy.

This imperative extends to SMEs in emerging economies that form part of the supply chains for large companies. Given that 60% of orders for raw materials made by companies such as Intel are transmitted electronically (Kotelnikov, 2007), a small company seeking to serve this segment that does

not have this technological capability would find it extremely difficult to do so. This underscores, once again, the importance of broadband access.

This is not necessarily the case for SMEs that serve low-value-added and labour-intensive domestic product markets (especially when the labour inputs are unskilled or semi-skilled). In these markets, SMEs tend to operate in areas with low ICT intensiveness, and the competitive pressure to participate in a supply ecosystem, such as those mentioned above, is not as strong, unless the SME is a supplier of a large local distributor or supplies a local provider that requires its buyers to use an automated platform.<sup>12</sup> If an SME is operating in an underdeveloped domestic market, the competitive pressure for automation may not be as intense.

Whatever category an SME may fall into, the pressure to reduce costs and improve its competitive position is an incentive for the adoption of ICTs. Academic research has determined that one of the main factors that leads SMEs to adopt ICT is the expectation that they will be able to modify their operations and become more efficient and thereby reduce their costs (Buuno et al., 2008). These authors consider that, beyond the traditional structural barriers (high cost of purchasing equipment or services), there is a cultural element that can operate as a barrier to ICT adoption when firms do not believe that value added is generated by adopting these technologies.

Despite the lack of empirical evidence, it is possible to continue formulating hypotheses regarding the contributions of broadband—as part of the ICT universe—to the performance of SMEs. These contributions may have a substantial impact, depending on the segment in question.

#### **D. Economic impact of broadband in Latin America and the Caribbean**

Research on the economic impact of broadband in Latin America and the Caribbean is a developing discipline. To date, few studies exist, and those that have been conducted are mainly focused on understanding the impact of technology in specific industries.<sup>13</sup> This section presents the first study that has been carried out to quantify the impact of broadband on GDP growth and job creation in the region.

---

<sup>12</sup> For example, Walmart does not work with suppliers that cannot operate with the multinational's inventory systems.

<sup>13</sup> See de Vries and Koetter (2008), Larios (2010), Barrantes (2010) and Camara (2010) for examples.

## **1. Impact on gross domestic product growth**

In a first study on the subject, Katz (2009d) presented a simple regression model linking broadband penetration and economic growth. Subsequently, research has advanced in developing a model of endogenous growth (Barro, 1991) that has been used by several researchers to assess the impact of broadband on the economic growth of a country (Qiang et al., 2009; Crandall et al., 2007; Garbacz et al., 2008).

Due to the lack of sufficiently extensive historical series on broadband penetration in the region,<sup>14</sup> a decision was made to conduct a cross-sample analysis of data for 2004-2008 based on an ordinary least squares (OLS) analysis with robust errors. Using this method potentially involves two types of problems, one produced by the omission of variables and one derived from the existence of endogeneity between independent and dependent variables.

The first problem, known as the “omitted variable” problem, produces a bias in the estimated coefficients. There are at least two ways to deal with this type of problem: by including “relevant variables”, and by using panel data (Islam, 1995). Due to the lack of global series for the countries of Latin America and the Caribbean, variables which may explain the observed differences in the trend of growth and employment in the countries to be analysed were included in this study. Specifically, it is expected that the inclusion of technology variables will mitigate the effects of variables that are not considered.

The second problem arises if there is a potentially endogenous relationship between economic growth (dependent variable) and the level of technology adoption (independent variable) which would lead to inconsistency and bias the estimates. The current literature recommends the use of equation systems and instrumental variables to deal with this kind of problem. For the particular case of estimating the effect of broadband penetration on growth, Koutroumpis (2009) developed an equation system in which the model for decisions regarding the supply and demand for bandwidth is a function of several variables, including the price of service. Although this approach is attractive, its application to emerging countries is extremely problematic due to the issues involved in the development of price series. Therefore, in designing a study on countries in the region, the independent variable was left out in an attempt to reduce the degree of endogeneity. At the same time, to

---

<sup>14</sup> Information is available on broadband penetration for most of the countries of Latin America and the Caribbean after 2003 (19 countries included in the sample).

generate a significant number of observations, a panel based on two distinct periods for each country was created. Table II.13 presents the variables used for this analysis:

Table II.13.  
**Variables used to measure the impact of broadband on economic growth in Latin America and the Caribbean**

Variable	Series	Sources	Observations
Economic growth	GDP growth for 2004-2006 and 2007-2009	World Bank and central banks	Dependent variable
Growth in broadband penetration	Growth in broadband penetration for 2001-2003 and 2004-2006	International Telecommunication Union (ITU) and national regulatory agencies	Independent variable
Investment level	Average investment/GDP for 2004-2006 and 2007-2009	World Bank	Measure to differentiate levels of capital investment
Population growth	Population growth during 2004-2006 and 2007-2009	World Bank	Measure to differentiate population size
Human capital	Tertiary education (2002)	UNESCO, Earthtrends, University of West Indies, Euromonitor, Government of the Commonwealth of Dominica	Measure to determine differences in human capital
Level of development	Per capita GDP at the start of 2003 and 2006	World Bank	Measure of starting point of growth
Level of globalization	Average of globalization index (2001-2003) and (2004-2006)	Dreher et al. (2008)	Measure to differentiate levels of economic, social and political integration

Source: Prepared by the author.

The results are presented in table II.14:

Table II.14.  
**Impact of broadband on economic growth in Latin America and the Caribbean**

GDP growth	Coefficient	Standard error	Statistic – t	P> t	95% confidence interval	
Growth in broadband penetration for 2001-2003 and 2004-2006	0.0158715	0.0080104	1.98	0.054	-0.0002942	0.0320372
Average investment/GDP for 2004-2006 and 2007-2009	-0.0471624	0.1689699	-0.28	0.782	-0.3881575	0.2938328
Population growth in 2004-2006 and 2007-2009	-0.4469177	1.40418	-0.32	0.752	-3.280668	2.386832
Higher education (2002)	0.2139614	0.1108325	1.93	0.060	-0.0097076	0.4376304
Per capita GDP at the start of 2003 and 2006	-0.0006957	0.0001806	-3.85	0.000	-0.0010602	-0.0003313
Average globalization rate for 2001-2003 and 2004-2006	-0.0653024	0.1929498	-0.34	0.737	-0.4546908	0.324086
Constant	13.02883	12.04659	1.08	0.286	-11.28217	37.33982

Number of observations	49
F(6,42)	7.18
Prob>F	0.0000
R <sup>2</sup>	0.3814
Root MSE	7,024

Source: Prepared by the author.



The regression results show that, when statistically controlling for the level of education and the starting point of economic growth, a 1% increase in broadband penetration contributes 0.0158% to GDP growth. This result is more optimistic than the estimate calculated by Koutroumpis (2009) for countries with less than 20% penetration and more pessimistic than the study of Katz et al. (2010a) for regions in Germany with an average broadband penetration of 24.8%. Finally, the model's estimation is markedly more conservative than those put forth in the study by Qiang et al. (2009) (see table II.15).

Table II.15.  
**Comparative estimate of the impact of broadband on GDP growth**

Study	Region/Country	Average penetration of broadband	Impact of an increment of 1% in penetration on GDP
This study	Latin America and the Caribbean	5.4% (2008)	0.0158%
Koutroumpis (2009)	25 OECD member countries	>20%	0.008%
Katz et al. (2010a)	Less developed regions of Germany	24.8%	0.0238%
Qiang et al. (2009)	Low-income and middle-income economies		0.138%

Source: Prepared by the author.

Based on this estimate, the contribution of broadband to GDP growth is calculated for Latin America and the Caribbean. According to projections of the International Monetary Fund (IMF), the region's economic growth was 3.4% between 2009 and 2010, resulting in a total GDP of US\$ 3.9 trillion. Assuming the possibility of bias in the sample (and given the limitation on the time series), a range of elasticity is determined that stretches from the value estimated by this model to the value determined by Koutroumpis (2009) for countries with broadband penetration below 20% (using a level of GDP contribution of 0.008%). Thus, using both ends of the impact range and given the level of broadband growth in the region between 2007 and 2008 (which was around 37%), the calculations indicate that it contributed between US\$ 6.7 billion and US\$ 14.3 billion. This impact includes direct (in the telecommunications industry) and indirect (spillover) effects.

## **2. Broadband and job creation: the case of Chile**

In addition to estimating the contribution of broadband to GDP growth, its impact on job creation was calculated. To this end, a data panel for Chile was created using quarterly data by region. This database was developed to collect information for each of the country's regions (except the Metropolitan Region, due to a lack of quarterly data) from 2001 to the fourth quarter of 2009. The database contains the information presented in table II.16.

Table II.16.

**Variables used to measure the impact of broadband on job creation in Chile**

Type of variable	Series	Source	Observations
Employment	Employment rate (2002-2009)	Regional statistical institutes	Dependent variable
Production level or economic activity	Economic activity index (2001-2009) <sup>1</sup>	Regional statistical institutes	Independent variable
Growth in broadband penetration	Growth in broadband penetration (2002-2009)	Office of the Under-Secretary for Telecommunications (Subtel)	Independent variable

Source: Prepared by the author.

The specific characteristics of each region that have an impact on the labour market (industrial sectors, education) are controlled for with the fixed effects of the panel data. The results of the model are presented in table II.17.

Table II.17.

**Chile: Impact of broadband on job creation**

Employment rate	Coefficient	Standard error	Statistic - t	P>[t]
Economic activity index (-1)	0.0003509	0.0000595	5.90	0.000
Growth in broadband penetration (-1)	0.18118	0.04708	3.85	0.000
Constant	0.8682527	0.0079638	109.03	0.000

Number of observations	324
F(2,310)	60.89
Prob>F	0.0000
R <sup>2</sup>	0.2820

Source: Prepared by the author.

As an alternative to this model, the education variable (the population's average years of schooling, by region) was included to control for the effects of human capital on job creation. Since a complete series for this variable was lacking, a smaller number (276) of observations was used. The results in this case remained significant. However, the coefficient of the human capital variable showed a negative sign (see annex II.1). This is due to a peculiarity in the Chilean labour market, which has been previously studied by Contreras et al. (2008), whereby unemployment increases as the education level rises due to specific inter-generational effects. Therefore, the original model, which excludes the variable of human capital but generates statistically significant results, was retained.

According to the model, a 1% increase in broadband penetration leads to a 0.18% increase in the employment rate. With an average employment rate of 93% of the economically active population, the Chilean workforce consists

of 6.5 million people. On this basis, it is estimated that, given that broadband penetration in Chile amounts to 9.78%, it made a contribution, through its direct and indirect effects, of 1.76% (114,426 jobs) to the employment rate. Obviously, job creation varies from one region and industrial sector to the next.

## E. Conclusion

In conclusion, research and analysis of the economic impact of broadband is a developing discipline. This chapter has presented the available research findings to date, which indicate that broadband is having a substantial social and economic impact. The studies that have been done on its economic impact illustrate its positive effects on GDP growth, job creation, productivity and innovation. These impacts are not confined to developed countries. Broadband's contributions to GDP growth and job creation have also been demonstrated with models constructed for Latin American countries.

The evidence generated to date also indicates, however, that the economic impact of the adoption of broadband depends on the conditions existing in each region, country and industrial sector. From the standpoint of public policies, broadband deployment should be complemented by actions that drive entrepreneurship as well as measures that foster the accumulation of intangible capital, such as business training, in order to maximize its economic impact.

## Bibliography

- Acil Tasman. (2004). *Economic Impacts of Broadband Adoption in Victoria*. Report prepared for Multimedia Victoria. ACIL Tasman Pty Ltd
- Atkinson, R., Castro, D. & Ezell, S.J. (2009). *The Digital Road to Recovery: A Stimulus Plan to Create Jobs, Boost Productivity and Revitalize America*, Washington, DC, The Information Technology and Innovation Foundation.
- Atrostic, B.K. & Nguyen, S.V. (2006). *How businesses use information technology: insights for measuring technology and productivity*. United States Bureau of Census, Washington, DC.
- Barrantes, R. (2010). The impact of mobile phones on profits from livestock activities - Evidence from Puno, Peru. Paper presented at the IV Conference of ACORN-Redecom, Brasilia, May
- Barro, R. (1991). Economic Growth in a Cross Section of Countries. *The Quarterly Journal of Economics*, Vol. CVI, No. 425, pp. 407-443
- Battese, G. & Coelli T. (1995). A Model for Technical Inefficiency Effects in a Stochastic Frontier Production Function for Panel Data. *Empirical Economics* 20: 325-332

- Bunno, T., Idota, H., and Tsuji, M. (2008). Comparative analysis of information communications technology use among Japanese SMEs. Paper submitted to the XVII Biennial Conference of the International Telecommunications Society. Montreal, June 24-27
- Camara, M. A. (2010). TICs para o desenvolvimento na zona rural: uma politica necessaria. Presentation at the IV ACORN-Redecom Conference, Brasilia, May
- Clarke, G (2008) . Has the internet increased exports for firms from low and middle-income countries? *Information Economics and Policy* 20
- Clayton, T., Franklin, M., Stam, P. (2005). *ICT impact assessment by linking data*. UK Office for National Statistics
- Contreras, D., L. de Mello and E. Puentes (2008), “Encouraging Labour Force Participation in Chile”, OCDE Economics Department Working Papers, No. 608, OCDE Publishing
- Crandall, R., Jackson, C., & Singer, H. (2003). *The Effect of Ubiquitous Broadband Adoption on Investment, Jobs, and the United States Economy*. Washington DC: Criterion Economics.
- Crandall, R., Lehr, W., & Litan, R. (2007). The Effects of broadband deployment on output and employment: a cross-sectional analysis of United States data. *Issues in Economic Policy*, 6.
- Crandall, R., & Singer, H. (2009). *The Economic Impact of Broadband Investment*.
- Czernich, N., Falck, O., Kretschmer T., & Woessman, L. (2009, December). Broadband Infrastructure and Economic Growth. CESifo Working Paper No. 2861
- Darby, L. F, Fuhr, J. P. Jr., & Pociask S. B. (2010). *The Internet Ecosystem: Employment Impacts of National Broadband Policy*. Washington, DC: American Consumer Institute for Citizen Research
- De Vries, Mulder, Dal Borgo & Hofman, (2007) *ICT Investment in Latin America: Does it Matter for Economic Growth?*. CEPAL.
- De Vries & Koetter. (2008). *How does ICT enhance productivity? Evidence from latent retail technologies in Chile*.
- Fornefeld, M., Delaunay, G. & Elixmann, D. (2008). *The impact of broadband on growth and productivity*. A study on behalf of the European Commission (DG Information Society and media), MICUS.
- Garbacz and Thompson (2008). *Broadband Impacts on State GDP: Direct and Indirect Impacts*. Paper submitted to the Telecommunications Policy Research Conference.
- Gillett, S., Lehr, W., and Osorio, C., & Sirbu, M. A. (2006). *Measuring Broadband's Economic Impact*. Technical Report 99-07-13829, National Technical Assistance, Training, Research, and Evaluation Project.
- Greenstein, S & McDevitt, R. (2010). *Broadband Internet's Impact on Consumers in Seven Countries*. New York: The Conference Board.
- Greenstein, S & McDevitt, R. (2009). *The Broadband Bonus: Accounting for Broadband Internet's Impact on United States GDP*, NBER Working Papers 14758
- Islam, N. (1995). Growth Empirics: A Panel Data Approach. *The Quarterly Journal of Economics*, MIT Press, vol. 110(4), pages 1127-70
- Katz, R. L., Zenhäusern, P. & Suter, S. (2008). *An evaluation of socio-economic impact of a fiber network in Switzerland*, mimeo, Polynomics and Telecom Advisory Services, LLC.
- Katz, R., & Suter, S. (2009a). *Estimating the economic impact of the broadband stimulus plan*. Columbia Institute for Tele-Information Working Paper
- Katz, R. L. (2009b). *La Contribución de las tecnologías de la información y las comunicaciones al desarrollo económico: propuestas de América Latina a los retos económicos actuales*. Madrid, Spain: Ariel.

- Katz, R. (2009c). The economic and social impact of telecommunications output: a theoretical framework and empirical evidence for Spain, *Intereconomics*, volume 44 – Number 1 – January/February
- \_\_\_\_\_. (2009d). *Estimating Broadband Demand and its Economic Impact in Latin America*. Document submitted to the ACORN REDECOM Conference 2009, Mexico City, September 5, 2009. <http://www.acorn-redecom.org/program.html>
- Katz, R. L., Vaterlaus, S., Zenhäusern, P., Suter, S. (2010a). The impact of broadband on jobs and the German economy. *Intereconomics*, January-February, Volume 45, Number 1, 26-34.
- Kolko, J. (2010). Does Broadband Boost Local Economic Development?. *Public Policy Institute of California Working paper*.
- Kotelnikov, V. (2007). *Small and medium Enterprises and ICT*. Bangkok: Asia-Pacific Development Information Programme
- Koutroumpis, P. (2009). The economic impact of broadband on growth: A simultaneous approach. *Telecommunications Policy*, 33, 471-485.
- Larios, G. (2010) Difusion de las TIC en los territorios de México: un análisis de relaciones causales. Paper presented at the IV Conference of ACORN-Redecom, Brasilia, May
- Liebenau, J., Atkinson, R. D., Kärrberg, P., Castro, D. & Ezell, S. J. (2009, April 29). The UK's Digital Road to Recovery. Retrieved from: <http://ssrn.com/abstract=1396687>
- Pociask, S.B. (2002). *Building a nationwide broadband: speeding job growth*. TeleNomic Research, LLC, Herndon, VA.
- Qiang, C. Z., & Rossotto, C. M. (2009). Economic Impacts of Broadband. In *Information and Communications for Development 2009: Extending Reach and Increasing Impact*, 35–50. Washington, DC: World Bank.
- Rincón-Aznar, A., Robinson, C., & Vecchi, M. (2006). *The productivity impact of e-commerce in the UK, 2001: Evidence from microdata*. The National Institute of Economic and Social Research, United Kingdom.
- Shideler, D., Badasyan, N., & Taylor, L. (2007, September 28-30). The Economic Impact of Broadband Deployment in Kentucky. *Telecommunication Policy Research Conference*, Washington D.C.
- Thompson, H., & Garbacz, C. (2008). Broadband Impacts on State GDP: Direct and Indirect Impacts. *International Telecommunications Society 17th Biennial Conference*, Canada.
- Varian, H., Litan, R., Elder, A. & Shutter, J. (2002). *The net impact study: the projected economic benefits of the internet in the United States, United Kingdom, France and Germany*, Available from: <http://www.cisco.com>
- Waverman, L., Meschi, M. & Fuss, M. (2005). The Impact of Telecoms on Economic Growth in Developing Countries. *Vodafone Policy Paper Series*, 2, London, United Kingdom.
- Waverman, L. (2009, February 29). *Economic Impact of Broadband: An Empirical Study*. London: LECG.

## Annex II.1

This annex presents an alternative model for measuring the impact of broadband on job creation. Its specification includes human capital variables as well as variables to control for differences in terms of the specialization of production in different regions. The variables are:

Table A.II.1.

**Chile: Variables used to measure the impact of broadband on job creation**

Type of variable	Series	Source	Observations
Employment	Employment rate (2002-2009)	Regional statistical institutes	Dependent variable
Production level or economic activity	Economic activity rate (2001-2009)	Regional statistical institutes	Independent variable
Growth in broadband penetration	Growth in broadband penetration (2002-2009)	Telecommunications Secretariat (SUBTEL)	Independent variable
Human capital	Education attainment for population over 15 years of age	Employment survey, National Institute of Statistics (INE)	Independent variable
Specialization	Contribution of dynamic sectors (2002-2009)	Central Bank of Chile	Control based on regional industries (financial & mining)
Specialization	Contribution of dynamic sectors (2002-2009)	Central Bank of Chile	Control based on regional industries (agriculture & commerce)

Source: Prepared by the author.

The results are as follows:

Table A.II.2.

**Chile: Impact of broadband on job creation**

Occupation rate	Coefficient	Standard error	-Statistic - t	P>[t]
Penetration of broadband (-1)	0.1774	0.0693	2.56	0.0110
INACER (-1)	0.000353	6.16E-0.5	5.72	0.0000
Educational attainment	-0.0042	0.002243	-1.87	0.0620
Dominant sector	-0.00133	0.000804	-1.66	0.0980
Dynamic sector	0.001743	0.001376	1.27	0.2060
Constant	0.913817	0.035212	25.95	0.0000

Number of observations	276
F(5,259)	20.78
Prob>F	0.0000
R <sup>2</sup>	0.2863
F(11,259)	24.41
Prob >F	0.0000

Source: Prepared by the author.

As can be seen in the above table, the coefficient for the penetration of broadband was stable despite the different model specifications (0.18 in the first model, 0.17 in the alternative model). It is important to note that

the variable used as a proxy for human capital —educational attainment of the population— was negative and significant. Contreras et al. (2008) show that this effect is to be expected due to two major changes in today's younger generations; first, the enormous change in the percentage of people enrolled in academic institutions and, second, the substantial increase in the number of women in the labour market.





### **III. Broadband: the new digital divide**

Valeria Jordán

The economic and social impact of broadband will vary depending on the way in which it is disseminated, as well as on the manner and extent to which it combines with other ICTs and key development variables (production structure, capabilities, innovation system and institutions). These technologies are complementary assets for the creation and dissemination of knowledge. Sectors that do not make use of these technologies will not only be deprived of their benefits but will also have a limited capacity for interaction with those that have them and for taking advantage of positive externalities, thereby giving rise to a digital divide that only further exacerbates the other divisions existing between different countries (ECLAC, 2010, Cimoli, Hofman and Mulder).

Indeed, while the innovations resulting from the digital revolution are a source of opportunities for growth, they also represent a threat to countries that do not make the necessary effort to disseminate the new paradigm and adapt it to their management and organizational processes, as well as to their production structures. This is especially the case for countries in Latin America and the Caribbean that are experiencing this revolution while trying to cope with economic and social development constraints and the lag inherent in the exogenous nature of technological progress in the world today.

It is therefore not surprising that the dissemination of broadband in the most advanced countries and in the countries of the region differs, and this is giving rise to a widening gap at the international level. The speed

with which leading countries innovate, and the consequent advancement of technology at the frontier (dynamic efficiency), outstrips the speed with which other countries learn, imitate, adapt and, consequently, narrow that gap. The speed of adoption (uptake) of such technologies is conditioned by social and economic factors that create gaps between different population segments within a country, as well. The two interacting types of gaps (external and internal) act as a constraint on the growth of developing economies (Peres and Hilbert, 2009). This is precisely the problem facing the countries in the region, as the broadband gap could deepen other asymmetries, such as gaps in innovation, productivity and equity, among others (Jordan, Peres and Rojas, 2010).

The countries in the region are in a difficult position in this respect, particularly since most developed countries are working to boost their broadband systems. This will only widen the new digital divide further. This is a particularly complex issue because of its multidimensional nature.

This chapter examines the ways in which the digital divide has evolved in the course of the development of broadband technologies and then goes on to gauge the magnitude of their various components.

## **A. From a one-dimensional to a multidimensional gap**

The broadband gap is a more complex issue than the traditional digital divide which originated with the emergence of the Internet. This is because, as discussed in chapter I, broadband is a dynamic and multidimensional system that encompasses much more than the use of the Internet to access simple applications such as Web browsing or e-mail. Along with the degree of the incorporation and use of content, applications and advanced electronic services, the quality of access becomes important, creating new dimensions in the digital divide: the quality of connectivity and the degree of digital appropriation. The way in which the digital divide has evolved will be reviewed here with a focus on how the technological progress of ICTs not only changes the issues to be addressed, but also requires that public policies be continuously adjusted.

### **1. The telephony gap: voice communications**

The term “digital divide” refers to the difference between the opportunities available to people who have effective access to ICTs and those open to people who do not. Its origin dates back to the mid-1990s

with the commercial development of Internet and the increase in the number of home computers. However, even before the emergence of ICTs, the least developed countries faced a gap in terms of their access to telecommunications services, in particular telephony. Figure III.1 depicts the dynamic existing among the elements that comprise the gap: network infrastructure, affordability and features of the relevant services, and availability of terminal equipment. The infrastructure needed to provide telephone services was based on mono-service networks, which were undemanding in terms of resources for routing traffic, while the operators of each service were limited to clearly defined markets. The basic functionality was voice communication, user-generated content and a relatively homogeneous quality; although there were differences between, for example, urban and rural areas, they did not affect use.

Figure III.1  
**Components of the gap in access to telephony**

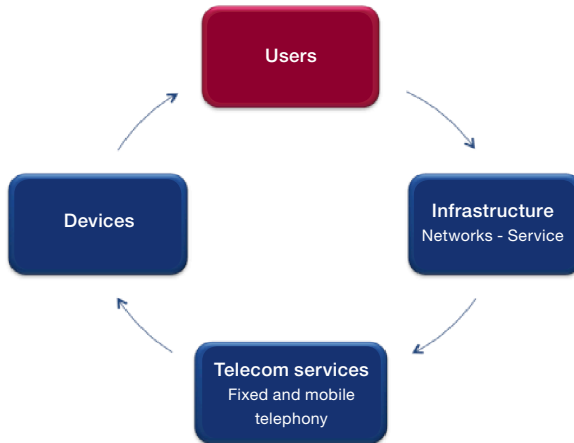

Source: Prepared by the author.

Fixed telephony was generally affordable, especially in urban areas, with the main constraints for users being its availability and the cost of the phone line. In mobile telephony, although the rates were initially high, prepaid plans and the “calling party pays” modality made the service affordable for a large percentage of the population. Fixed telephones were usually provided by the operators, whereas, in the mobile market, a wide range of mobile phones

with various features and functions in addition to voice communication became available, and their cost fell quickly, especially in the case of the less sophisticated devices.

The factors limiting the dissemination of telephony were infrastructure and service affordability. Since using a telephone requires minimal skills, the gap in telephony was exclusively rooted in access issues. Because of this and because services were uniform, this gap was one-dimensional and, within the telecommunications sector, it was dealt with through regulatory reforms designed to increase market competition and block anti-competitive practices and market dominance through universal access policies providing for the expansion of public fixed-telephony networks.

## **2. *The digital divide: internet access***

By the mid-1990s, the Internet's potential as a driver of economic growth had become clear in developed countries. Being a general-purpose technology, its impact varied depending on the sector concerned and its degree of dissemination and use. This opened up a new two-dimensional gap: *access*, as a function of the coverage of the service and its dissemination among the different economic agents; and *use*, in terms of agents' capacities for handling the technology (see figure III.2).

The access gap originally referred to narrow-band Internet service with dial-up or Integrated Services Digital Network (ISDN) connections with theoretical maximum speeds of 56 kbps and 128 kbps, respectively; later, the focus shifted to access to first-generation broadband speeds of 256 kbps. These developments were triggered by technical advances in data transmission, which led to the use of the IP protocol. An environment of technological convergence emerged in which circuit-switched and packet data transmission networks co-existed, driving the development of multiservice networks. These changes transformed the dynamics of telecommunications markets by facilitating competition in services among different network operators. Telephony service providers began to compete with cable television providers in the Internet access service market, which led to an increase in the number of service providers that a potential customer could choose from, in addition to making it more affordable.

Figure III.2  
**Components of the digital divide**

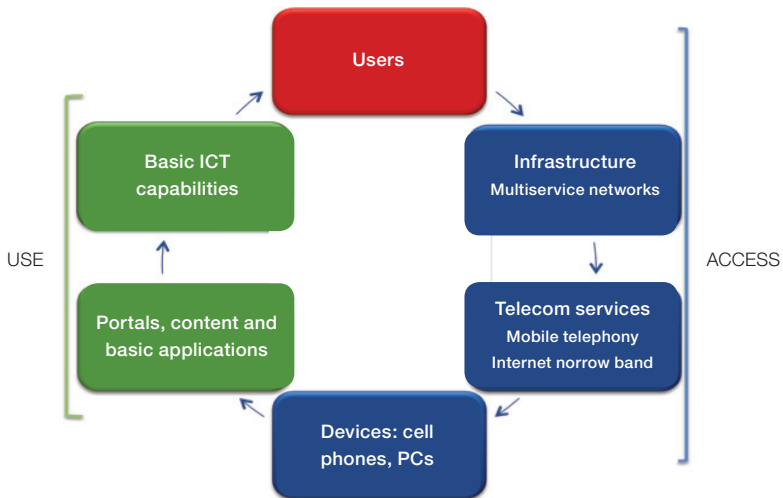

Source: Prepared by the author.

At this stage, Internet access made it possible to use services such as e-mail, to surf the World Wide Web (WWW) and to take advantage of other slightly more advanced IP services, such as VoIP. This was a consistent service for users that offered the access to what were basically the same benefits, although the user experience improved with increased connection speeds that allowed users to obtain faster and better-quality services such as VoIP. Internet access gradually became more significant as it began to offer increased functionality and enable multimedia communications (text, voice, audio and video).

Terminal equipment was limited to desktops and laptops, and the hardware was not associated with the provision of access service. The high price of such equipment and the cost of access service were the main obstacles to dissemination. In the least developed countries, this led to the emergence of public access centres that helped to diminish the gap.

The economic and social impacts of the Internet are heavily influenced by the type of use that is made of it, and this depends, in turn, on the availability and diversity of relevant and useful content and applications for users. The development of portals and content in local languages was

therefore essential. At this stage, communication was unidirectional and reactive, with information content being written in hypertext format,<sup>1</sup> while applications, for the most part, did not allow for real-time interaction. Also, this was generally one-to-one (from one individual or computer to another) communication or one-to-many communication. The applications were developed for individual use by private computing resources, i.e., software designed to carry out user tasks or activities stored on computers or servers. In this area, new actors, such as hardware and software producers and content generators, took on decisive roles in the development of the digital paradigm, which added complexity to its dynamic.

In this context, the basic skills required to use a phone were no longer enough, and it became evident that users were going to have to attain digital literacy, understood as the development of the skills needed for the generation, organization, analysis and management of information through ICTs, including hardware management and the use of the Internet and software. As a result, new facets of the digital divide began to emerge which called for more complex policies, since they had to reach beyond the telecommunications sector in order to address the various components of the paradigm. To this end, countries developed cross-cutting and comprehensive strategies for the development of the information society that required the creation of a special institutional structure

### **3. *Broadband: the new digital divide***

Technological progress in the provision of broadband access is changing the digital paradigm in significant ways. Given its ability to transmit large volumes of data and make the use of more advanced applications viable, broadband embodies the digital revolution's potential for economic growth and social development and is giving rise to a system in which its components are developed within an environment supported by this technology. The associated technical progress is proceeding at breakneck speed and is transforming the system's components, adding multiple dimensions and complexity to the digital divide. In the process, the access gap has gone from being an issue of connectivity and use to one of digital ownership (see figure III.3).

---

<sup>1</sup> Text on the screen of an electronic device that leads the user to another related text.

Figure III.3  
**Broadband: the dimensions of the new digital divide**

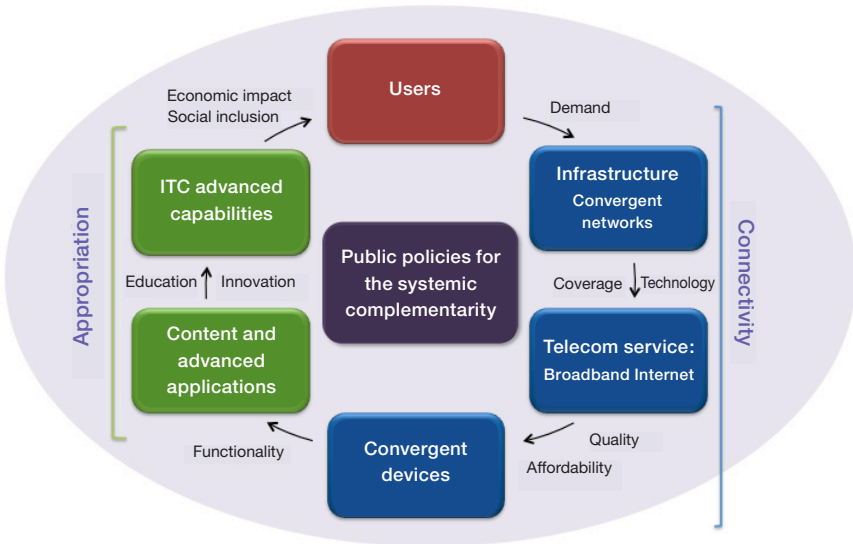

Source: Prepared by the author.

In terms of infrastructure, technical progress poses challenges in regard to network technology and coverage. The convergence of networks and services and the growth of Internet traffic are driving the deployment of next-generation technologies with greater transmission capacity which require more network resources and a more intelligent system of traffic management. These networks support the delivery of multiple services via broadband, which makes it necessary to improve subscriber access and distribution networks (backhaul). By 2020, the capacity of these networks in Latin America will have to increase by a factor of 100 in order to support the volume of data traffic and the millions of devices that will be in operation (Nixon, 2010). In this sense, as will be discussed in greater detail in chapter IV, the choice of which technology to adopt will be of crucial importance, since the transmission capacity of the various options will determine the path of digital development.

The existence of various broadband access technologies with widely differing connection speeds (from 256 kbps to 100 Mbps) is a new aspect to consider in relation to the digital divide, in addition to the traditional problem

of coverage. Transmission capacity determines the functionality of the service, which is no longer uniform. As discussed in chapter I, users with slow connections are limited to the use of simple applications, while better connectivity not only improves users' experience with those applications, but also gives them access to services based on more sophisticated applications and cloud computing.

In this environment, the issue of service affordability becomes more complex because current business models (segmentation based on ability to pay and intensity of use) restrict access to advanced services, which hold out the greatest potential for social inclusion. In the countries of Latin America and the Caribbean, the high cost of connections (in particular the fastest ones) and low levels of per capita income render the service unaffordable for most of the population. Additionally, the cost of acquiring access devices must be evaluated. Equipment, especially the most sophisticated types, continues to be out of reach for most people in many countries, although the dynamic in this market has led to sharp declines in prices. This factor also influences the use of technology, since the characteristics of the equipment (computing power, storage, media, connectivity, screen size, etc.) influence its use.

In order to maximize the potential of broadband, it is becoming increasingly necessary to develop online content and applications that are adapted to access devices and add value to the network. Market dynamics are currently driving continuous innovations in the areas of production and entertainment, while the pace of innovation is slower in areas such as health, education and governance. Moreover, digital literacy is now essential in the workplace and for social inclusion. As more advanced ICT skills come to be required, it is expected that the education system will focus on inculcating the skills needed to adopt and appropriate the necessary technological tools.

Thus, broadband is the central element of a new development dynamic based on information and knowledge, whose evolution depends on the synergy among the elements that comprise it: network infrastructure; access quality and dissemination; availability of applications and content to create value; and necessary skills for their effective use and development.

Access infrastructure is a necessary condition within this system, which is why public policies generally place priority on deploying and upgrading networks. However, investment in broadband will have a greater impact if accompanied by improvements in other system components. The most



advanced countries are working in this direction as they strive to develop institutional policies to coordinate different economic and social sectors to take advantage of spillover effects and create complementarities. In order to cope with the issues posed by the digital divide in broadband use, the various dimensions of the issue must therefore be addressed, with priority being placed on different aspects depending on the level of development of each country.

## **B. The magnitude of the digital divide**

### **1. The connectivity gap**

#### **(a) Infrastructure: networks and technology**

##### *Network coverage and subscribers*

The way in which the ICT technological frontier is constantly shifting makes the gap in access to these technologies a moving target; as progress is made to close the gap in a specific service, a new one is opened up by some other emerging technology. The dynamic within the sector is such that the time between the appearance of one new development and the next is becoming shorter and shorter, thus making the race to the frontier increasingly difficult. In the 1980s, the key service was fixed telephony; later, in the mid-1990s, it became mobile telephony and, then, in the late 1990s and early 2000s, narrowband Internet, which was followed by broadband in 2005.

In recent years, countries in Latin America and the Caribbean have made progress in reducing the external access gap, measured as the difference between the average penetration rate of services in the countries of the region and the equivalent rate in member countries of the Organisation for Economic Co-operation and Development (OECD). This difference has declined in fixed telephony services and, in particular, in mobile telephony. However, the gap is greater and is widening at an exponential rate for broadband Internet access, both for wired-connection users and mobile broadband subscribers (see figure III.4).

Figure III.4  
**Access gap between OECD and Latin America and the Caribbean,  
 by type of service, 1980-2009**  
*(Percentage points)*

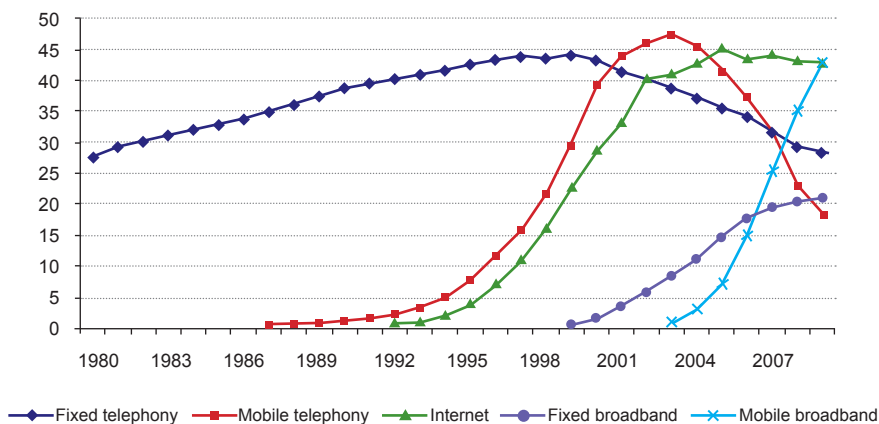

Source: ECLAC, based on data from the International Telecommunication Union (ITU), World Telecommunications Indicators Database, 2010.

Note: The access gap is the difference between the penetration levels of services in the countries of Latin America and the Caribbean and in member countries of OECD. The average penetration rate has been used for measurement purposes. The penetration rate for fixed telephony, mobile telephony and broadband corresponds to the number of subscribers of these services as a percentage of the total population. Internet penetration is calculated as the number of users, measured as a percentage of in the total population.

The region falls within the average range of global access to fixed telephony, with a penetration rate of 18% of its population as of 2009 and, at a rate of 89%, is well above the world average penetration rate for mobile telephony of 68%. The number of Internet users in the region has also grown substantially in recent years, climbing from a penetration rate of 17% in 2005 to 31% in 2009. The region is positioned above the world average of 27%, but behind Europe and North America, which had rates of 63% and 76%, respectively, in 2009. During the same period, while there was a sharp increase in the number of broadband connections, penetration rates in the region were lower than the global average of 8% in fixed broadband and 10% in mobile, with penetration levels of 6% and 4%, respectively. This places the region well behind Europe and North America, where more than 30% of the population has access to this service. The lag is particularly large in the adoption of mobile broadband, with the region's penetration rate being the second-lowest in the world, after Africa (see figure III.5).

Figure III.5  
**Penetration of telecommunications services, by region, 2009**  
 (Percentages)

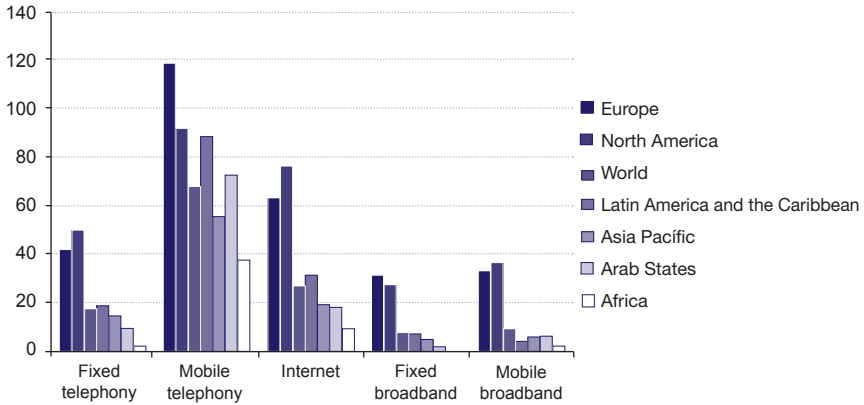

Source: ECLAC, based on data from ITU, World Telecommunications Indicators Database, 2010.

In the countries of the region, the increase in Internet penetration has not been accompanied by similar increases in the capacity of international bandwidth. International bandwidth per 1,000 Internet users rose from 1 Mbps in 2005 to 5 Mbps in 2009, while in OECD countries it rose from 4 Mbps to 27 Mbps over the same period. Limited connection speeds have a negative impact on quality and service capabilities.

To facilitate an analysis of the status of broadband in the region, figure III.6 shows the penetration rates for fixed and mobile broadband for selected countries. The global trend points to a significant expansion of mobile broadband, which has become the predominant means of access. In OECD countries, mobile access rates are double the rate for fixed access and, in countries such as Egypt, Indonesia and the Philippines, mobile Internet is four, five and nine times greater, respectively, than fixed access. Although, at the region-wide level, the penetration rate of this service in Latin America and the Caribbean was less than a tenth of the level that it was in OECD (4.2% versus 47%), the penetration rate for mobile broadband was twice as high as the fixed broadband access rate in Trinidad and Tobago and the Bolivarian Republic of Venezuela and was three times higher in Guatemala and Nicaragua. The countries with the highest penetration rates for mobile broadband in 2009 were Trinidad and Tobago, followed by the Bolivarian Republic of Venezuela, Argentina, Mexico and Brazil. This development has been driven by the deployment of 3G networks, increased availability of devices equipped for the use of this technology and prepaid payment plans. In fixed broadband, the difference between the Latin American and Caribbean region and the OECD countries is smaller (being equivalent to a factor of four: 6% versus

27%). Fixed broadband still outweighs mobile broadband in the region, but this situation is expected to reverse itself in 2011. The best-performing countries are Chile, Mexico, Argentina, Trinidad and Tobago, Brazil, the Plurinational State of Uruguay and the Bolivarian Republic of Venezuela, although none of them has as many as 10 connections per 100 inhabitants. Ecuador, Suriname, Nicaragua, Guatemala, Guyana and Honduras lag the furthest behind, with penetration rates below 1% in the last four countries.

Figure III.6  
Fixed and mobile broadband penetration rates in 2009  
(Percentages)

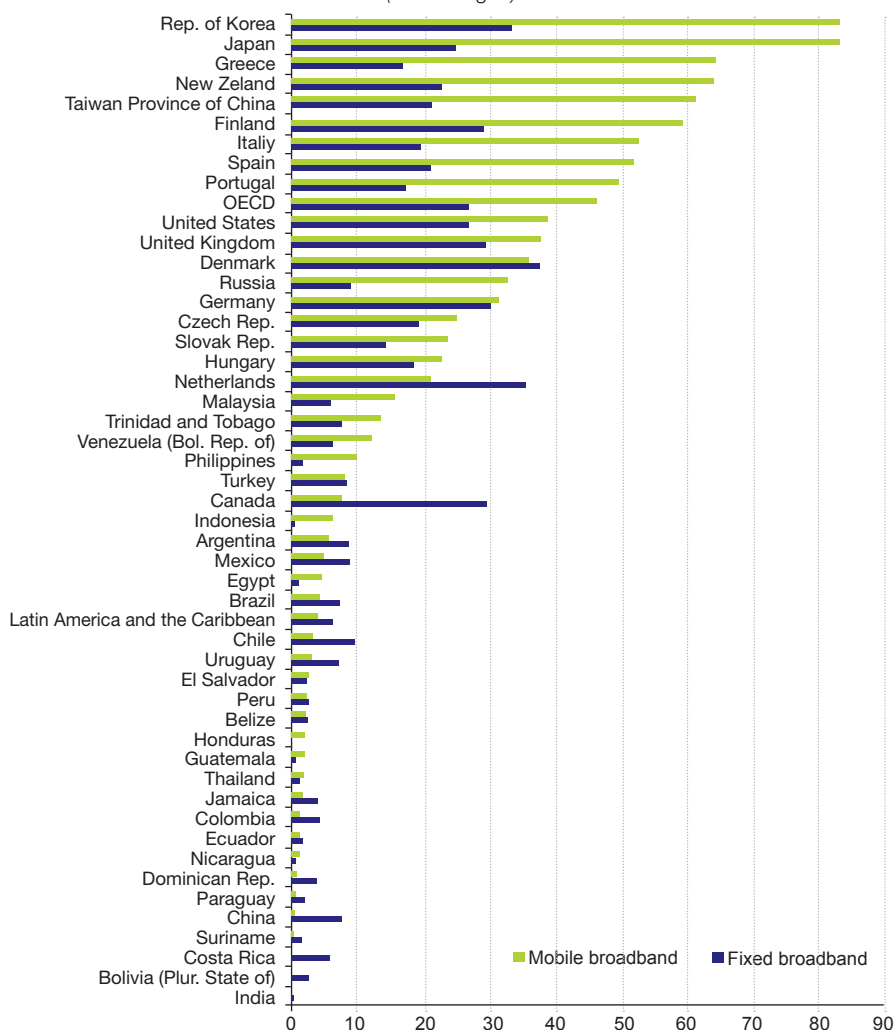

Source: ECLAC, based on data from ITU, World Telecommunications Indicators Database, 2010.

Calculating broadband penetration based on the number of households, rather than the number of inhabitants, does not substantially alter the countries' rankings (see figure III.7). The two indicators match for the five worst-performing countries and for four of the five leading ones (Brazil is replaced by the Bolivarian Republic of Venezuela in fifth place.) The most marked change in the ranking is for Uruguay, which fell four places; this can be accounted for by the fact that it has the smallest household size in the region. When measured in terms of households, the gap with OECD countries also narrows. (The OECD average is 2.8 times higher than the average for the region, as opposed to 4.2 times higher for the per capita penetration rate.) These figures reflect the difference in average household size between the two regions (about 4 people per household in Latin America and the Caribbean versus 2.5 people per household in OECD countries in 2009).

Figure III.7  
Fixed broadband connections per 100 households, 2009

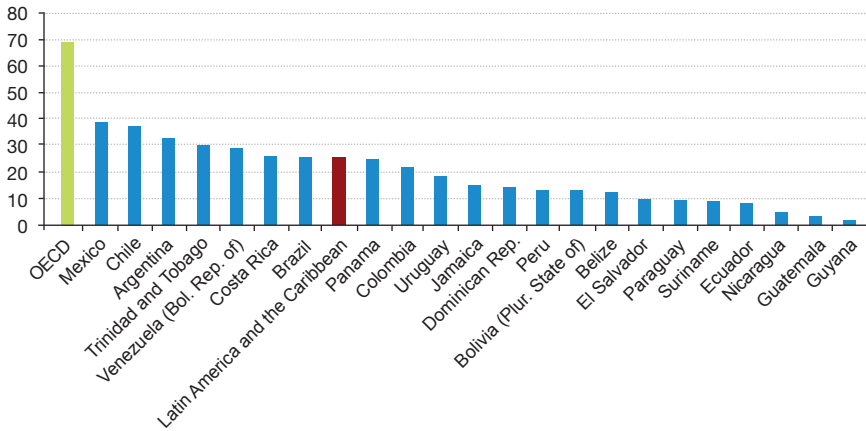

Source: ECLAC, based on data from ITU, World Telecommunications Indicators Database, 2010.

Trends in mobile broadband use do not follow the same pattern as for fixed broadband in terms of income levels. In the case of fixed broadband, the higher per capita income is, the higher the penetration of the service is (with the exception of the Republic of Korea, which greatly exceeds expectations based on per capita GDP). There is not such a direct correlation in mobile connectivity, and there is a significant variance in the spread of services across countries with similar income levels (see figure III.8). These differences are explained by the lower prices of devices and access plans, as well as regulatory adjustments in the telecommunications sector such as the liberalization of the electromagnetic spectrum to facilitate the service's expansion.

Figure III.8  
**Relationship between penetration of fixed broadband and mobile broadband,  
 by per capita GDP, 2009**

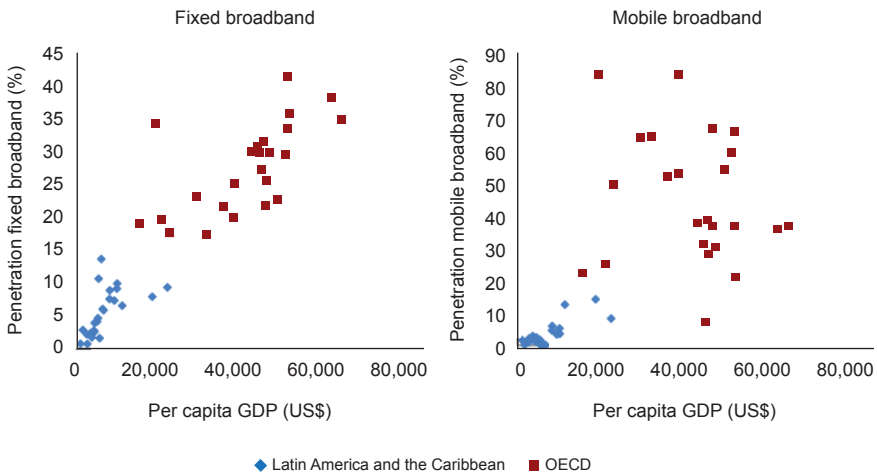

Source: ECLAC, based on data from ITU, World Telecommunications Indicators Database, 2010.

Thus, as will be discussed further in chapter VI, given the degree of income inequality and lack of basic infrastructure existing in many countries of the region, in addition to the geographical dispersion of the population and the difficult terrain that makes some areas largely inaccessible, mobile broadband can be an efficient means of reducing the digital divide because of its lower network deployment costs and its payment facilities (pre- and post-pay schemes that include terminal equipment).

The region's already low levels of penetration drop even further outside its capital cities and metropolitan areas, where the coverage and scope of networks falls off sharply. This, in turn, is related to the level of development of different regions, provinces or localities, as is demonstrated by the fact that the region of Antofagasta in Chile, where mining activities are concentrated, has an even higher broadband penetration rate than the country's capital city does. In Brazil, the most developed regions have service penetration levels above the national average, and this situation is replicated to a greater or lesser extent in the rest of the countries shown in table III.1.

Table III.1  
**Broadband penetration in selected Latin American countries**  
*(Percentages)*

Country	Penetration > National average	National penetration	Penetration < National average		
Argentina (June 2009)	City of Buenos Aires	46.2%	9.3%	Mendoza	6.9%
	San Luis	12.9%		Cordoba	5.2%
	Neuquén	11.3%		Santa Fe	3.7%
				Jujuy	0.2%
Brazil (December 2009)	São Paulo	11.4%	6.0%	North	3.5%
	South	7.6%		North-east	1.4%
	South-east	6.3%			
	West central	6.1%			
Colombia (June 2009)	Bogotá	12.3%	4.7%	Coffee-growing region	4.1%
	Antioquia	6.4%		Cundinamarca	3.3%
	Boyacá	5.9%		Valle-Chocó-Nariño	2.2%
Chile (March 2010)	Antofagasta region	13.7%	9.9%	Atacama region	8.1%
	Metropolitan region	12.9%		Bío Bío region	7.7%
	Valparaíso region	10.7%		Lib. B. O'Higgins region	5.3%
				Maule region	4.3%
Peru (December 2009)	Lima	6.2%	2.9%	La Libertad	2.7%
	Arequipa	3.5%		Ica	2.3%
	Tacna	3.5%		Moquegua	2.1%
				Lambayeque	2.1%

Source: ECLAC, based on Cisco Broadband Barometer and data from the Subsecretariat of Telecommunications of Chile.

This dichotomy is especially marked between urban areas and rural areas in which infrastructure expansion is not a profitable venture. Figure III.9 not only illustrates the heterogeneity of Internet penetration across countries in the region, but also shows, as noted above, that the digital revolution is, in many cases, occurring only in large cities. Uruguay, Costa Rica and Mexico have the smallest differential between rural and urban areas of all the countries in the region. With Internet penetration rates in rural areas at 9.2%, 7.4% and 6.3%, respectively, they exceed even the urban areas of El Salvador, the Plurinational State of Bolivia and Honduras.

Figure III.9  
**Internet access in urban and rural households**  
*(Percentages)*

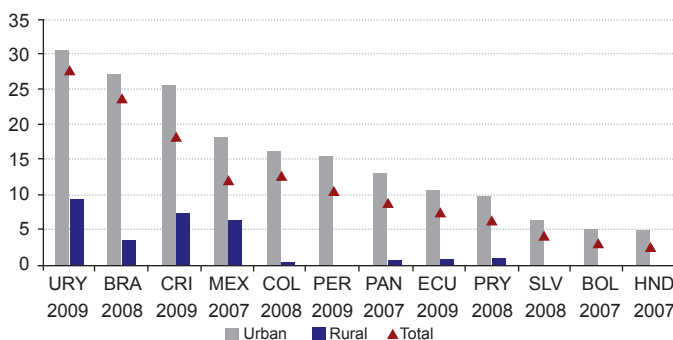

Source: ECLAC, the Observatory for the Information Society in Latin America and the Caribbean (OSILAC), based on information from household surveys conducted by national statistics institutes for the most recent year available.

Unlike the most developed countries, where the expansion of the Internet is determined by preferences, interests, generational constraints and, to a lesser extent, the expansion of infrastructure, in Latin America and the Caribbean socio-economic variables, such as income and education levels, are the determining factors. Figure III.10 shows the differences in access to ICT services of households with different income levels. In 10 countries of the region, where the average access to mobile telephony in the richest households is twice as great as that of the poorest households, the gap in Internet access amounts to a factor of 37, and this gap grew even wider in 2005-2010, according to OSILAC.

Figure III.10  
**Household access, by income quintile, in selected Latin American countries**  
*(Percentages)*

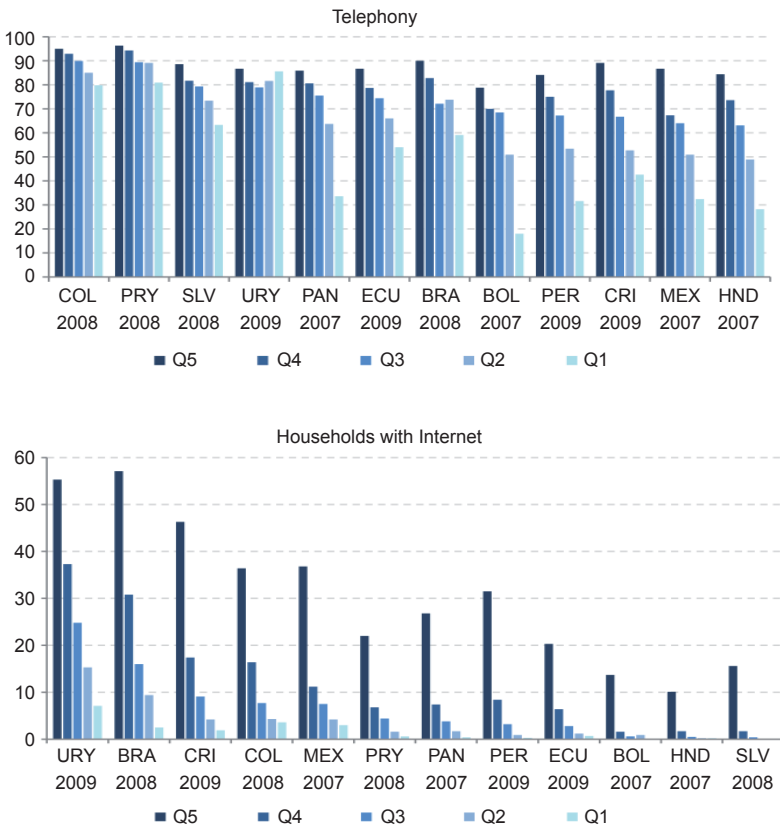

Source: ECLAC, Observatory for the Information Society in Latin America and the Caribbean (OSILAC), based on information from household surveys conducted by national statistics institutes for the most recent year available.



In most of the countries in the region, mobile telephony is widespread in all population segments. Although this trend is not as strong in the Plurinational State of Bolivia, Honduras and Mexico, the subscriber base is very large in all countries. Having a strong mobile phone platform creates opportunities for the popularization of the Internet through mobile broadband. As shown in chapter VI, this opens up an opportunity for significantly increasing access.

Shared access is an effective means of addressing the digital divide, since it facilitates the inclusion of the poorest segments by providing them with access to ICT services, equipment and training (see figure III.11). However, because shared access entails low connection speeds, transfer costs and the use of a shared environment, it does not provide ideal conditions for Internet use. This results in lower use rates in terms of the time spent on the Internet and the use of advanced applications. In particular, it is not the appropriate solution in areas such as education and employment, which require continuous, frequent use in environments conducive to concentration.

Figure III.11  
**Internet use, by access point**  
(Percentage of users between 15 and 74 years of age)

Country and year	Brazil 2008	Costa Rica 2008	Ecuador 2009	El Salvador 2008	Honduras 2007
Home	60	38	34	31	17
Public access center	35	40	62	45	77
Another person's home	19	6	7	2	ND
Work	37	36	25	12	21
School	15	10	26	9	13

Country and year	Mexico 2009	Panama 2007	Paraguay 2008	Peru 2009	Uruguay 2009
Home	47	31	39	28	65
Public access center	35	41	38	64	25
Another person's home	3	5	6	ND	17
Work	25	33	24	18	33
School	8	14	13	5	10

Source: ECLAC, Observatory for the Information Society in Latin America and the Caribbean (OSILAC), based on information from household surveys conducted by national statistics institute for the most recent year available.

To leverage ICT in order to increase social inclusion, connectivity must be addressed by opening up multiple options, from shared access to mass residential access. In Latin America and the Caribbean, although there have been significant advances in both directions, the problem is far from resolved, particularly in view of the fact that the quality of connections,

i.e., the connection speed rather than access per se, is becoming increasingly important. In fact, countries with a very good performance in terms of service penetration do not necessarily excel in terms of other aspects of the gap, which makes a multidimensional approach all the more valuable.

*Technologies and network development: digital communication capacity*

Unlike the traditional digital divide produced by the Internet, in which users' and subscribers' access to the service was a relevant indicator, in the case of broadband access, technology assumes a central role because it determines the data transmission capacity, which, in turn, determines whether or not advanced applications and services will be accessible. From this perspective, an assessment of the magnitude of the digital divide based on the number of subscribers to a service is unsuitable because the differences in transmission capacity associated with different technologies need to be taken into account. This is why it is important to examine network development in terms of access technology, particularly since technological progress is increasing this capability exponentially.

Wired and wireless technologies have various performance variables, one of which is data transmission capacity. The broadband access technologies used in Latin America and the Caribbean are similar to those used in the rest of the world, but their degrees of diffusion and performance differ depending on their architecture and use of network resources. In the region, in 2009, 20% of wireless networks were 3G networks, while 4% of total wirelines were digital subscriber line (xDSL) technology. Worldwide, 13% of fixed telephone lines have been upgraded to xDSL, and 3G represents just over a fifth of wireless technologies (Yongsoo, Kelly and Raja, 2010). Regionally, this points to a lag in the modernization of the wireline network. The situation of the countries of Latin America and the Caribbean is as follows:

- The most commonly used wired technologies are xDSL and those that combine cable modem with optical fibre (Hybrid Fibre Coaxial, HFC).
- xDSL services offer lower quality and speed than in developed countries, given the increasing age of telephone lines and the greater distances between user locations and the corresponding switchboards.
- The networks for cable modem services usually have lower HFC fibre capillarity, resulting in nodes that share a higher number of

"homes passed". Given that the capacity is divided among a greater number of users, the highest potential speed is lower.

- Fibre optic (FTTx) deployment is still in its infancy and is available commercially only in some of the higher-income metropolitan areas of Argentina, Brazil, Colombia and Chile. In developed countries, in contrast, there are fibre deployments to the home or to the cabinet<sup>2</sup> and VDSL (Very High Speed DSL) that allow higher speeds and, as a result, a greater transmission capacity (see figure III. 12). Asian countries account for around 80% of this technology in the world (Vanier, 2010).

Figure III.12  
**Market share, by technology and world region (2009)**  
*(Percentages)*

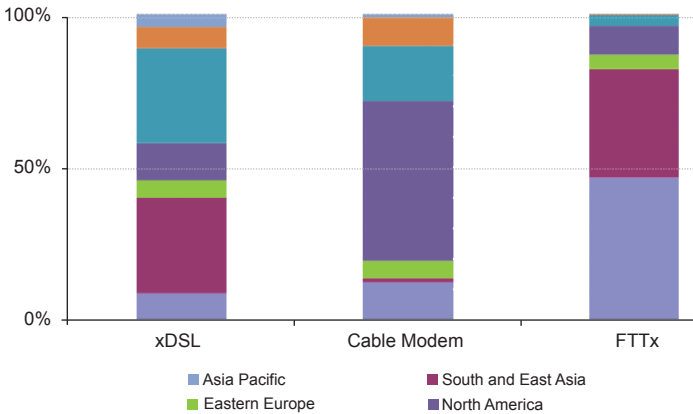

Source: Point Topic, World Broadband Statistics, Q4 2009, March 2010.

In terms of wireless modes of access in the region, it can be said that:

- The deployment of wireless infrastructure is denser than it is in the case of fixed technologies, while the situation in regard to network deployment is more similar to what is seen in developed countries. However, the sharing of radiobase stations between users is more intensive, which results in a lower download speed.

<sup>2</sup> A system for laying fibre optic cables up to a point of local loop concentration, known as the "feeder distribution interface," which can serve hundreds of subscribers.

- WiMAX technology is less developed in the region but this is not having a major effect on the deployment and use of broadband, as is also true in the more advanced countries.
- The deployment of mobile broadband is slower due to constraints in respect of the allocation of the electromagnetic spectrum and delays in licensing, although this situation appears to have been improving since 2009. This development is driven by the rapid deployment of 3G networks (HSPA) and the greater availability of devices for this technology. In October 2010, about 60 such networks were registered in the region (3G Americas, 2010).
- As of October 2010, the only HSPA + networks in operation were in Chile, while 4G networks (LTE) were still in the planning and testing phases, with initial commercial deployments planned for the end of 2013.
- Broadband satellite connections are limited and are generally used only to reach remote areas. Given the characteristics of this technology, its lower level of deployment has a greater impact in terms of the popularization of Internet service.

By cross-referencing the degree of diffusion of each technology in each country with its data transmission capacity, it is possible to gauge the total capacity for information exchange. This indicator of connectivity is an increasingly useful tool for evaluating digital development. Even if the countries of Latin America and the Caribbean were to reach the same penetration rates as the most developed economies, a gap in the transmission of information would remain because they would be accessing the same service with inferior technology or with similar technologies but under conditions that reduce their performance (for example, via 2.5 technology instead of 3G or higher or cable modems passed through too many households).

Figure III.13 shows the number of kbps per capita that can be transmitted with cable modem and xDSL technologies in Latin America and the Caribbean and the European Union in order to compare the total transmission capacity (download and upload) in the two regions. The gap has widened significantly since 2003. In 2008, an inhabitant of the European Union had 497 kbps more than people in Latin America and the Caribbean did; five years earlier, the difference was only 27 kbps (Hilbert, López and Vásquez, 2010). By measuring the gap in terms of a per capita comparison of fixed Internet subscribers, it can be seen that the more advanced countries are pulling further ahead of

the less advanced ones. In 2008, the broadband penetration rate in European Union countries was 2.3 times higher than in Latin America and the Caribbean (26.7% vs. 11.6%), while the gap in transmission capacity was nearly five times greater (625 kbps versus 128 kbps).

Figure III.13  
**Total broadband transmission capacity in Latin America and the Caribbean and the European Union, by technology, cable modem and xDSL**

(kbps per inhabitant)

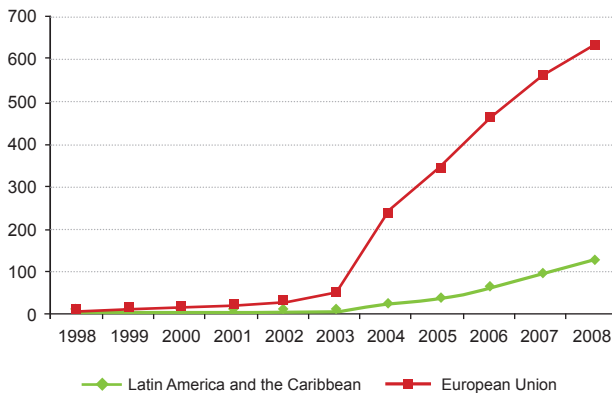

Source: Martin Hilbert, Priscilla López and Cristián Vázquez (2010), "Information Societies or 'ICT equipment Societies'? Measuring the digital information processing capacity of a society in bits and bytes", *The Information Society: An International Journal*, vol. 26, issue 3.

Note: Capacity is calculated as the product of the number of subscribers to the different technologies and the transmission rate for each

As will be discussed in the next chapter, the differences are even more striking when fibre optic technology (which made its appearance in the region in mid-2010) is included, since the increase in the number of broadband subscribers in the region has not been accompanied by an increase in transmission capacity (see table III.2). Indeed, between 2000 and 2007, the region increased its share of broadband subscribers worldwide from 0.5% to 8.2%, while, at the same time, its share of total transmission capacity dropped from 2.9% to 1.1%. As explained above, this has a negative impact in terms of the possibility of using more advanced applications.

Table III.2  
**Latin America and the Caribbean: share of total internet access worldwide**  
 (Percentages)

	1993	2000	2007
Broadband subscribers	0.5	4.4	8.2
Transmission capacity	0.2	2.9	1.1

Source: Prepared by the author on the basis of information presented in chapter IV.

### (b) Access to services: quality and affordability

#### *Quality of connections: speed and latency*

The distinction between the gap in access and the gap in connectivity—determined by transmission capacity—is of crucial importance, as the latter is the one that reflects the actual ability to exchange information. Figure III.14 shows the lag existing in the region with regard to the highest download speeds, which is another reflection of this gap. When comparing the fixed broadband download speeds available in Latin America and the Caribbean and selected OECD countries, it becomes clear that not only is there a significant difference between the two regions, but that there is also a considerable degree of heterogeneity within each of these regions. The average rate offered in OECD countries is 12 times greater than that of the Latin American and Caribbean region (30.6 Mbps compared to 2.5 Mbps). But the range of connection speeds offered in OECD countries varies from 20-25 Mbps in Italy and Belgium to 1 GB in Portugal and the Slovak Republic. In the region, Chile, Argentina and Brazil have the highest speeds (20-30 Mbps), but these speeds do no more than approach the lowest speeds available in Europe. In most of the other countries, the maximum speeds offered are less than 10 Mbps. In Guatemala, the Bolivarian Republic of Venezuela, El Salvador, Nicaragua and Cuba, the highest offered speed does not exceed 2 Mbps.

Figure III.14  
**Maximum download speeds offered in fixed broadband in selected countries, 2009-2010**  
 (Mbps)

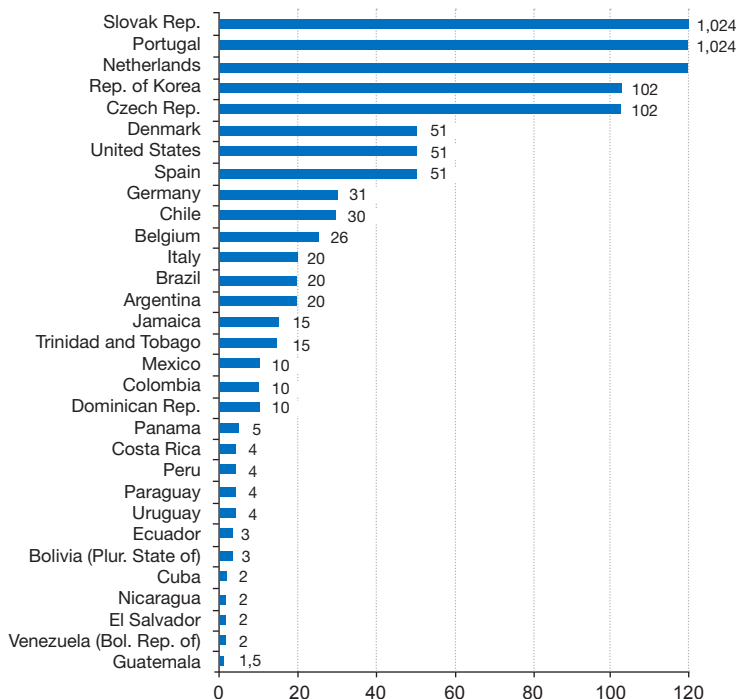

Source: ECLAC, based on data from OECD, online site <http://www.oecd.org/sti/ict/broadband>.

Note: This graph reflects the current data for all available technologies. The information for Latin America and the Caribbean is the information published by major service providers in each country as of March 2010; OECD data correspond to October 2009. The data include bundled services, as high-speed broadband services are available only in this modality.

Furthermore, the majority of commercial packages in the region offer speeds between 512 kbps and 2 Mbps, followed by the range of 2 to 10 Mbps. Figure III.15 shows that narrowband (less than 256 kbps) is still an important element in the market for Internet access, particularly in Argentina, Trinidad and Tobago, and the Plurinational State of Bolivia, where it represents about 30% of the total.

Figure III.15  
**Commercial Internet access packages in Latin America and the Caribbean  
 based on offered speeds, March 2010**  
*(Percentages)*

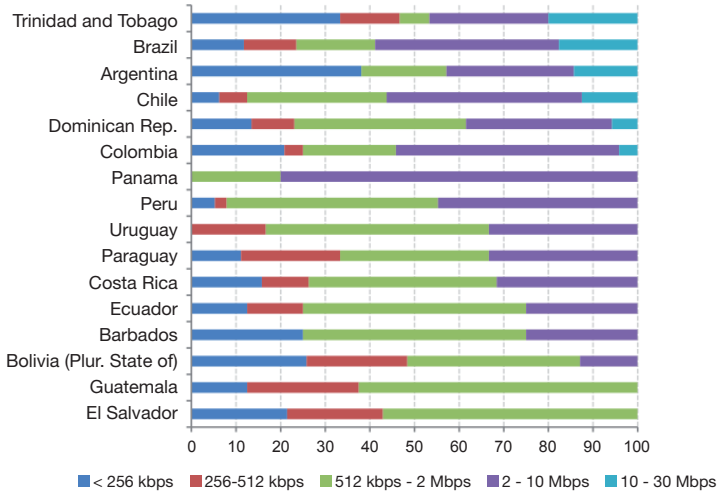

Source: Prepared by the author on the basis of information from the main operators in each country.

According to these supply parameters, in many countries a significant number of users are subscribed to connections with download speeds ranging from 1 - 2 Mbps (see table III.3). In comparing information from the end of 2008, when most subscriptions fell within the range of from 512 kbps to 1 Mbps, it becomes apparent that definite progress has been made, although, in some countries, the percentage of connections over 2 Mbps is still small. Moreover, in most countries of the region, commercial packages have upload speeds of only 256 kbps, which is very low vis-à-vis the requirements of Internet users who are carrying out work-related activities or using social networks. In particular, that speed is insufficient for voice, video or telecommuting that involves exchanging large files and for simultaneous activities that include, for example, voice, video and e-mail. The inadequacy of these speeds is even more apparent in the case of remote diagnostics, remote education and e-government applications, which demand much higher transmission capacities.



Table III.3

**Internet connections, by connection speed**

	< 256 kbps	256 - 512 kbps	512 kbps - 1 Mbps	1 – 2 Mbps	> 2Mbps
Argentina (June 2009)	2%	10%	39%	49%	0%
Brazil (June 2009)	10%	25%	27%	38%	
Colombia (March 2010)		7%	32%	39%	22%
Costa Rica (June 2009)	10%	26%	37%	20%	7%
Chile (June 2010)	2%	3%	12%	57%	27%
Peru (June 2009)	7%	39%	44%	10%	0%

Source: ECLAC, based on the Cisco Broadband Barometer, data from the Subsecretariat of Telecommunications of Chile and the Ministry of Information Technologies and Communications of Colombia.

Commercial offerings illustrate the diversity of broadband access options in the market and, to some extent, their development potential. However, to evaluate the actual quality of the connections in terms of speed of access, the effective capacity of data transmission must be considered. Figure III.16 outlines the average effective upload and download speeds in Latin America and the Caribbean and the OECD countries as of September 2010. Again, there is a wide range. In the most developed countries, the average download speed is 12.5 Mbps and the average upload speed is 3.5 Mbps, compared to 2.4 Mbps and 0.7 Mbps, respectively, in Latin America and the Caribbean. Although in both cases the upload speed is four times lower than the download, the OECD average speeds are high enough to permit the use of sophisticated interactive applications and multimedia.

The countries in the region with the highest effective download speeds are Trinidad and Tobago, Chile, Jamaica and Brazil, with speeds exceeding 4 Mbps; this is similar to the speeds found in the OECD countries with the lowest rates (Italy and Turkey). At the opposite end of the spectrum are the Plurinational State of Bolivia, Belize, Guatemala and the Bolivarian Republic of Venezuela, with speeds below 1 Mbps. In regard to the effective upload speed, with the exception of Honduras, Chile, Jamaica and Saint Lucia, where the speed slightly exceeds 1 Mbps, the rest of the countries in the region have an average speed of 0.5 Mbps. Among OECD countries, the top-performing countries register speeds of 8 Mbps—with the exception of the Republic of Korea with speeds of 20 Mbps—while the poorest performers have upload speeds of around 1 Mbps.

Figure III.16  
Average effective upload and download speeds, September 2010  
(Mbps)

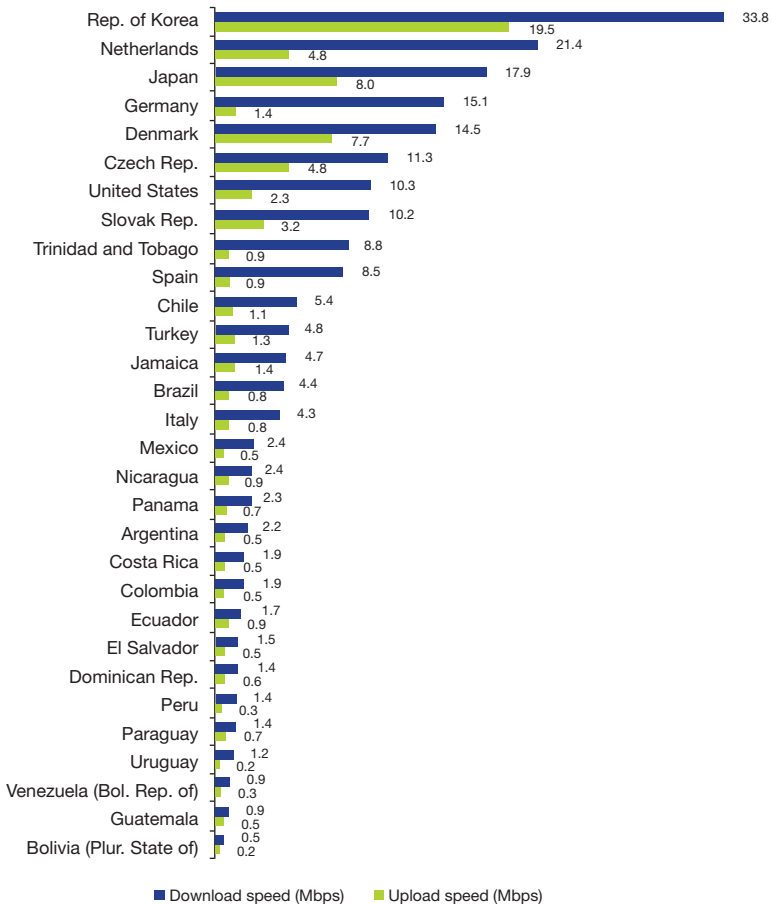

Source: [www.netindex.com](http://www.netindex.com) based on data from Speedtest.net

Note: The value is the average mobile performance in Mbps during the latest 30-day in which the average distance between the client and the server was less than 300 miles (483 km).

Although the *actual* download and upload speeds in OECD countries are five times higher than those in Latin America and the Caribbean, this ratio is even higher for *advertised* connection speeds, which are over 12 times faster in OECD countries than the average advertised in the region. As a result, the gap in *actual* speed, which is what influences how technology can be used, is less than what would be expected given the existing supply.

For an overview of the preparedness of countries to address current and future connectivity demands, figure III.17 shows the index of broadband quality (*Broadband Quality Score*),<sup>3</sup> which reflects an evaluation of connection quality in terms of download speed, upload speed and latency (Said Business School and University of Oviedo, 2009). This index illustrates a new dimension of the digital divide in which the countries of the region are also lagging far behind.

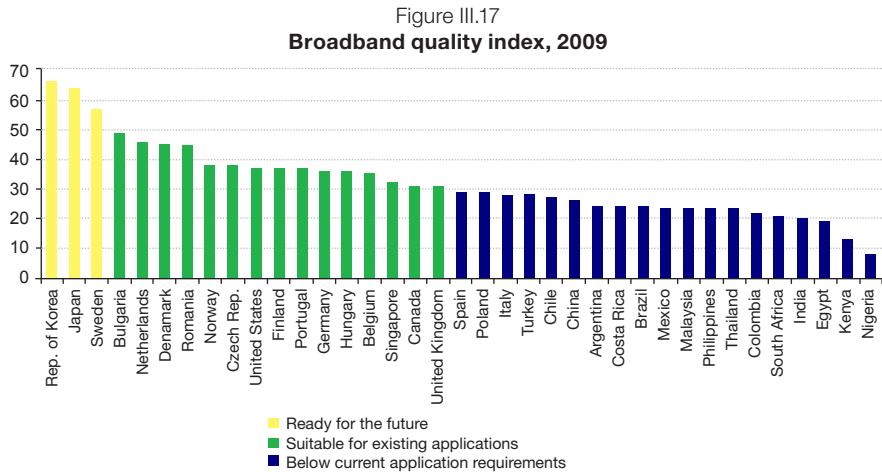

Source: CISCO, Broadband Quality Study, prepared by the Said Business School, University of Oxford, and University of Oviedo, 2009. Calculations based on data from Speedtest.net for May-July 2009.

### *Affordability of services*

As previously mentioned, countries' per capita income levels and service fees underlie the external gap in broadband penetration. In Latin America and the Caribbean, high service fees combined with relatively low income levels compare unfavourably with the situation in OECD countries. In 2009, the average price for 100 kbps bandwidth was US\$ 5.8 in the region versus US\$ 1.3 in OECD countries (excluding Mexico), while the average per capita GDP was US\$ 6,000 in the region versus more than US\$ 40,000 in the OECD countries (de León, 2010).

<sup>3</sup> The index is calculated by weighting three variables—download, upload and latency—in terms of information exchange requirements. For the purposes of the index, a download speed of 3.75 Mbps, an upload speed of 1 Mbps and 90 ms of latency are considered to be the current requirements. These variables are weighted at 55%, 23% and 22%, respectively. Future requirements—a presumed download speed of 11.25 Mbps, an upload speed of 5 Mbps and latency of 60 ms—are calculated by weighting the download speed at 45%, upload at 32% and latency at 23%.

Next, broadband access fees and the affordability of this service for the general population will be analysed. This analysis focuses on fixed broadband access fees, since they are the dominant mode in the region for DSL and cable modem connections.<sup>4</sup> The monthly fees differ sharply across the countries of the region and, in some cases, within them, e.g., the Plurinational State of Bolivia, Peru and Colombia (see figure III.18). These variations are due to price differences for ADSL and cable modem technologies and for different geographical areas, which have different transmission costs and different capacities in terms of economies of scale, with small towns located far from the moorings of submarine cables being at the greatest disadvantage.

Figure III.18  
**Monthly cost of fixed broadband and its relation to monthly per capita gross domestic product**  
*(Percentages, US\$ / 100 kbps per month)*

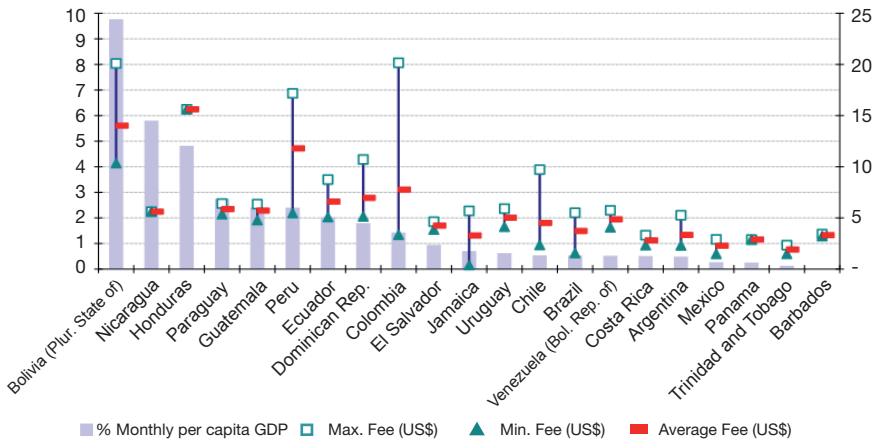

Source: Omar de León (2010), on the basis of information from operators of broadband services from August-October 2009, using downstream speeds of 1 Mbps as a reference rate.

The average monthly cost for a use level of 100 kbps in the Plurinational State of Bolivia and Honduras is between US\$ 14 and US\$ 15 (6% and 10% of per capita GDP per month, respectively), while in Trinidad and Tobago,

<sup>4</sup> Given that the terms and conditions offered for mobile broadband differ from those available for fixed broadband, neither modality is a substitute for the other. The multiplicity of mobile broadband plans offering different speeds of transmission, capacity limits on data transfer in both directions, handling methods if capacity is exceeded (speed reduced to 64 Kbps or 128 Kbps, charging per MB transmitted, among others), etc., makes a comparison with fixed broadband plans impossible.

Mexico, Costa Rica and Panama, the cost does not exceed \$ 3 per month (about 1.3% of per capita GDP per month). The average monthly cost of 100 kbps in the region is US\$ 5.8, equivalent to 2% of average per capita monthly income. These figures are very high, particularly if one considers that 100 kbps is no longer considered to be broadband. The cost of connections of up to 1 Mbps represent 10% of monthly income in many countries of the region, and as much as over 50% in the most extreme cases. At these values, a large part of the population cannot afford this service.

In the same vein, studies in Brazil and Chile in 2009 indicate that the high cost is one of people's main reasons for not using the Internet. The Brazilian study's findings indicate that the main reasons cited by the 76% of households that do not have Internet access were economic reasons (48%), the ability to access Internet outside the home (22%), lack of service coverage (22%), a lack of need or interest (8%) and, to a lesser extent, reasons such as a lack of the necessary skills and security issues (Brazilian Internet Steering Committee, 2010). In Chile, 87% of non-Internet users who do not plan to contract broadband service indicated a lack of interest and need, with cost appearing to be of secondary importance (Subsecretariat of Telecommunications of Chile, 2009).

### **(c) Availability of terminal equipment**

Another aspect of the connectivity gap associated with purchasing power is the cost of terminal equipment. As mentioned above, the technological sophistication of these devices facilitates broadband access. In the early 2000s, the main means of access were desktop computers, followed by laptops. Currently, there is a wide range of options thanks to the emergence of netbooks and mobile computers such as smart phones, PC tablets and others. At the household level in Latin America and the Caribbean, computer use is still lower than it is in more developed countries, with an average penetration rate of 25% versus 75% (see figure III.19). In the best-performing OECD countries (the Netherlands, Sweden, Japan and Denmark), this value exceeds 85%, while the lower range is around 60% (Portugal, the Czech Republic and Italy). In the region, the best results were recorded in Uruguay, followed by Chile and Costa Rica, with penetration levels of 48%, 40% and 37%, respectively. In contrast, in El Salvador, only 11 out of 100 households have computers, while in Peru, Panama, Paraguay and the Bolivarian Republic of Venezuela, the penetration level is 20%.

Figure III.19  
**Households with computers**  
 (Percentages)

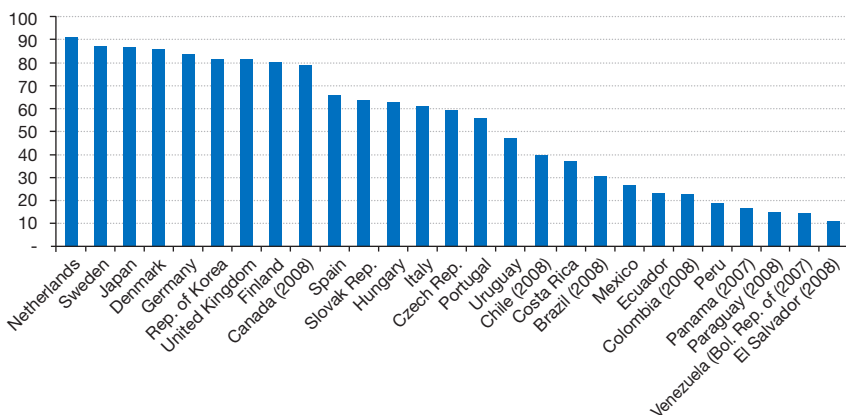

Source: ECLAC, the Observatory for the Information Society in Latin America and the Caribbean (OSILAC), based on information from household surveys conducted by national statistics institutes, the most recent year available and OECD data from its online site <http://www.oecd.org/sti/ict/broadband>.

The popularization of computer equipment in the region has proceeded slowly, given its high cost (between US\$ 500 and US\$ 2,000, depending on its characteristics) relative to per capita income, despite the efforts of many governments to reverse this situation through policies that include lower taxes, subsidies and the implementation of programmes such as the “One Laptop Per Child” campaign.

In this context, portable devices, particularly netbooks, emerge as an option for connectivity at a lower price. According to IDC data for the period from the third quarter of 2008 to the third quarter of 2009, while the Latin American market for desktop computers declined by 1%, the market for laptops increased by 52% (Temboury, 2010). This dynamic is attributable to the decline in prices and strong marketing efforts, in addition to the fact that mobile operators in many countries include the device as part of their broadband packages, allowing consumers to purchase it in instalments.

A price analysis of netbooks throughout the region (see figure III.20) shows that, with the exception of the Bolivarian Republic of Venezuela, where the average price is US\$ 700, values fluctuate between US\$ 300 in Mexico and US\$ 500 in Brazil, for an average of US\$ 430 (6% of annual per capita income). While a netbook costs less than a desktop, netbooks cost more in the region than in countries such as Spain, the United Kingdom, the United States and France, where the average cost of a netbook is US\$ 310 (1% of annual per capita income).

Figure III.20  
**Average price of netbooks in selected countries relative to annual per capita income, May 2010**  
*(US dollars and percentages)*

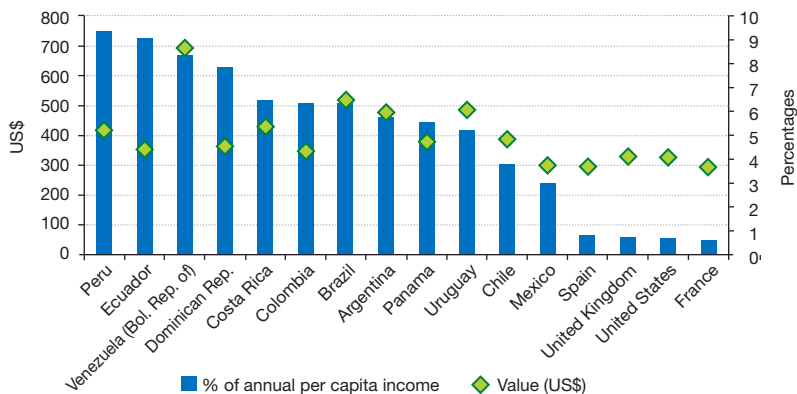

Source: ECLAC, based on information from service providers.

Note: The values shown correspond to the average price of at least three brands in the market for new netbooks having at least 160 GB, 1 GB RAM, N270Atom processor, 1.6 GHz and a 10.1" screen.

The lion's share of the market for mobile phones is made up of simple devices, while smartphones represent only 6% of the total (IDC, 2010). This value, although it doubled in 2009, is well below the world market average (12 out of 100 devices were smartphones in 2008). Brazil, Mexico, the Bolivarian Republic of Venezuela, Argentina, Chile and Peru are witnessing the strongest growth in this market, with these countries accounting for 90% of sales in the region (Salvador, 2009).

The lower penetration rate for smartphones in Latin America and the Caribbean is due to their high cost, especially compared with netbooks, which offer more features at a similar or lower price. Even so, market forecasts project a strong expansion of these devices, with their growth being driven by competition between mobile operators that see data traffic as an important source of income and smartphones as a means of encouraging that traffic. Since this would bring down prices, the remaining challenge for this market would then be the development of data-hungry applications.

## 2. The digital divide

Overcoming the digital divide requires that ICTs become integrated into daily life in ways that are conducive to activities that generate benefits for society as a whole. The development, dissemination and use of content and applications that have a positive impact on economic and social well-being should therefore

be promoted. The types of uses that are high up on most of the Latin American and Caribbean countries' digital agendas are e-government, e-education, e-health and e-business. In particular, e-government is seen as the most direct way to promote the use of online services among individuals and businesses.

Sustainable, equitable development of the information society must be based on dialogue and exchange between cultures and regions, and developers of content and applications must therefore address issues relating to the cultural and linguistic diversity of the population on a national and regional level. Local-language content and applications that address users' interests and needs are essential. Providing relevant, culture-specific content is an important way to bring ICTs closer to different groups within the population, and building local capacity for the production of software and content in those groups' native languages is therefore an important step.

For the region, this variable is yet another dimension of the digital divide. Despite the clear preference for native-language content (81% of pages visited worldwide are in users' local languages) (Fosk, 2010), there is a disproportionate ratio between the number of Spanish- and Portuguese-speaking Internet users and the number of websites available in these languages (see figure III. 21). The difference is even greater for indigenous languages. The situation is somewhat similar in terms of applications, which are usually adaptations of applications developed in advanced countries and therefore do not meet local needs.

Figure III.21  
Internet users and websites, by language, 2000-2008  
(Percentages)

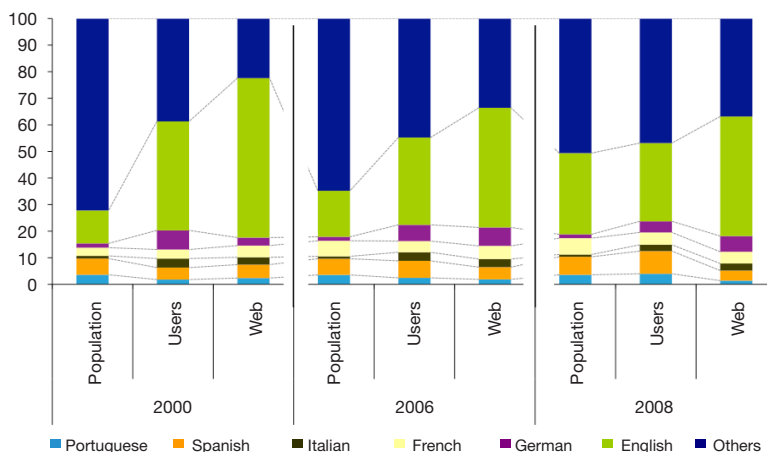

Source: ECLAC, based on data from the Observatory of the Languages and Cultures on the Internet, a project of FUNREDES (acronym in Spanish for Fundación Redes y Desarrollo) and the website Internet World Stats, 2009.



Communication is the main use made of the Internet in both Latin America and Europe. However, the use of applications in the fields of government, banking and commerce in the region is much lower; this points to a very basic type of Internet use in the region, which is not conducive to achieving the economic and social impact that ICTs can potentially have. These findings are in line with the results of a study on the status of the Internet in Latin America conducted by comScore which indicates that the primary uses being made of the Internet in the region are Web browsing, followed by interaction in social networks and e-mail (see figures III.22 and III.23).

Figure III.22  
**Internet use, by type**  
*(Percentage of users from 15 to 74 years of age)*

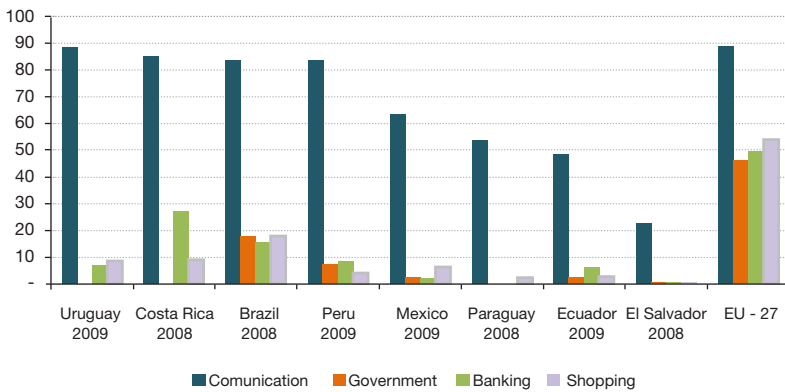

Source: ECLAC, the Observatory for the Information Society in Latin America and the Caribbean (OSILAC), based on household survey data.

Figure III.23  
**Internet use, by type of site visited**  
*(Percentage of users)*

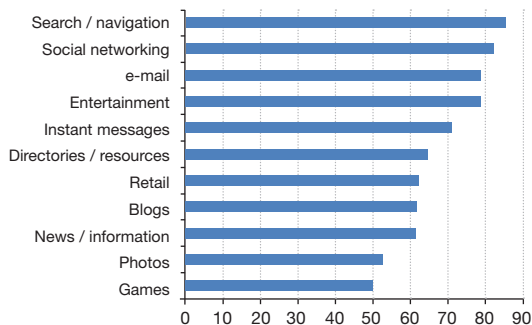

Source: comScore World Metrix, 2010.

It is worth noting that, despite low levels of broadband penetration, over 75% of Internet users access multimedia entertainment sites (music, movies, television and videos). The exchange of this type of content is driven by the widespread use of social networks. The most widely used applications are Google, among search engines, Facebook and Orkut (Brazil) as social networks, Hotmail for e-mail and YouTube for entertainment. In this universe, as well as in terms of news and information sites, there is significant local content development. The use of sites such as the Rede Globo and Terra has expanded rapidly, with this growth being spurred by the demand for national and regional content. YouTube has launched sites in Argentina, Brazil and Mexico to facilitate access to content produced in these countries (Fernández, 2010).

This signals a change in content access patterns. Until recently, most content was available primarily in the United States. The growth of peer-to-peer communication has significantly changed the flow of information. Currently, there are a large number of users who are simultaneously consumers and generators of content. The directions in which information flows are based on common interests regarding certain types of content. For example, music from a certain region is shared mostly by users of that geographic area. A similar situation exists in television programming and news. The use of content that is located in the areas where it is produced/occurs will reduce the cost of the traffic, since international links are not required, thereby facilitating the popularization of the service (Echeberria, 2010). Taking into account the consumer preference for local content and the fact that 70% of international traffic in the region in 2008 was headed to the United States (see table III.4), it is clear that many of those users were not seeking United States content, but rather Latin American content which is hosted in the United States, possibly due to lower hosting costs there.

Table III.4  
**Internet traffic flow, by region, 2001-2008**  
*(Percentages)*

	2001	2008
<b>Asia</b>		
Intraregional	17%	33%
With the United States and Canada	80%	54%
<b>Europa</b>		
Intraregional	75%	75%
With the United States and Canada	25%	21%
<b>América Latina</b>		
Intraregional	12%	29%
With the United States and Canada	88%	70%

Source: TeleGeography, 2009.

Moreover, as mentioned above, the true impact of broadband depends on the availability of applications that provide social returns, particularly in the areas of education, health and governance. The countries of the region are making headway in these areas, although broadband development at increasingly higher speeds calls for greater efforts in the generation of more advanced applications.

The development of educational portals has encouraged the creation of digital resources by increasing the availability of text content, images and sound files, as well as links to related sites. However, less than 70% of these portals make educational software available or provide links to sites where users can communicate with each other, and less than half offer distance learning courses (see figure III.24).

Figure III.24  
**Resources provided by educational portals, 2010**  
(Percentages)

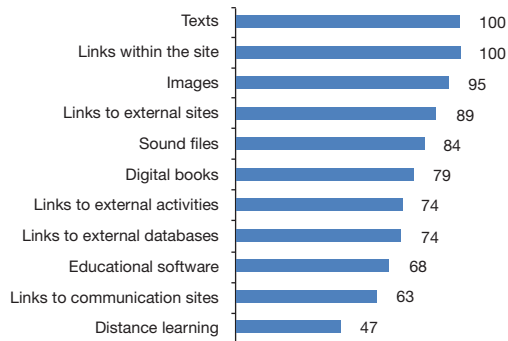

Source: ECLAC, "Monitoreo del plan eLAC2010: avances y desafíos de la Sociedad de la Información en América Latina y el Caribe" (Monitoring of the eLAC2010 plan of action: advances and challenges of the information society in Latin America and the Caribbean), 2010.

The development of e-health is less advanced. Although all of the relevant ministries in the region have official health-related websites, their content is mostly institutional information and does not provide the public with data on health systems, diseases or their treatment or information on how to complete health-care procedures. Only seven countries (Chile, Ecuador, El Salvador, Guatemala, Mexico, Paraguay and Peru) provide a way of locating health services through the ministry's website, and transactions can be carried out via those websites in only four countries (Brazil, Chile, Mexico and Uruguay). As for online health services, tele-medicine is just beginning to realize its potential for overcoming the access problems

experienced by people in remote locations or in areas where certain types of specialists are lacking.

With regard to e-government, over 75% of public-sector websites offer institutional information, providing access to sector-specific regulations and standards in digital format and links to other areas. About 20% of these sites allow two-way communication and offer transactional services. The use of ICTs as a means of facilitating citizen participation is in its infancy and thus far has focused on delivering information rather than consultations with members of the public. The one-stop shop for taking care of paperwork is still not widespread and, in many countries, the online procedures that are available are not transactional. The focus has been on front-office applications, while little progress has been made in system interoperability, and this is hampering the transition to more advanced stages of interaction and information exchange (ECLAC, 2010b).

Many of the constraints on the further development of digital services have to do with the cost of creating appropriate applications and the cost of certain types of equipment, such as high-capacity servers that require a great deal of maintenance. Cloud computing is one option for simplifying operations and reducing these costs, and it is beginning to take off in the region. It is, however, still concentrated in the financial and entertainment fields, and its full potential in social services has yet to be realized.<sup>5</sup>

The final element that completes the virtuous circle of broadband is the ability to use and appropriate it. A lack of skills inhibits the use not only of computers but also of interactive applications in such areas as e-government. Even basic Internet use, such as information searches, is beyond the capabilities of many would-be users. A significant portion of the population in the region lacks such skills, mainly due to a low level of education. In general, people with more years of formal education are the ones who use the most advanced ICTs, and this is particularly evident in the case of the Internet. Thus, the majority of Internet users are people with tertiary or some other sort of post-secondary educations, who represent only 11% and 31%, respectively, of the region's population.

Age is also a determinant of ICT access and use, as young people tend to have a greater ability and willingness to adopt new technologies. The highest rates of use in the region correspond to the age brackets of 15-24 years and 25-34 years, which together represent about 30% of the population. Adults access

---

<sup>5</sup> For example, Telefónica offers backup applications in the the cloud in Chile; it is developing software as a service (SaaS) applications in Argentina; and it implementing music streaming services in Colombia and Brazil.

the Internet primarily for information, while young people use it as a tool to meet their entertainment and social interaction needs. This type of use is more sophisticated because it is focused on interactive and multimedia applications. For this age segment, the Internet's main functions are: communication via e-mail, chat, VoIP, etc.; browsing and downloading content; participation in social networks and entertainment in the form of online games, radio and digital television; and online purchases (Foundation Telefónica, 2008). Carrying out these activities facilitates the development of skills involved in the selection and management of information and the advanced use of ICTs. The more contact that people have with technology, the less training they need in order to be able to use new applications and devices and the less reluctant they will be to do so. It is therefore important to facilitate access to ICTs from early childhood on and to guide children in making appropriate use of them so that they will build the skills they will need as adults to enhance their and others' overall economic and social well-being and, in turn, complete the digital development cycle.

## Bibliography

- 3G Americas (2010) "UMTS-HSPA Deployments in Latin America", *3G Americas*, [online] <<http://www.3gamericas.org/index.cfm?fuseaction=page&pageid=324>> [Retrieved on: September 16, 2010].
- Cimoli, Mario, André Hofman y Johan Mulder (2010) *Innovation and Economic Development. The Impact of Information and Communication Technologies in Latin America and the Caribbean*, Edward Elgar.
- Brazilian Internet Steering Committee, Comit  Gestor da Internet (2010), "Pesquisa sobre uso das tecnologias da informa o e comunica o no Brasil 2009", *Centro de Estudos sobre as Tecnologias da Informa o e da Comunica o*, Sao Paulo, Brazil.
- Communities and Local Government (2008), *Community, opportunity, prosperity. Annual Report 2008*, Department for Communities and Local Government, <[online] <http://www.communities.gov.uk/publications/corporate/annualreport08>>, May.
- Echeberria, Ra l (2010), *Desarrollo de infraestructura e interconexi n regional*, Latin America and Caribbean Internet Addresses Registry (LACNIC), Montevideo, Uruguay.
- ECLAC (2010a), *Las TIC para el crecimiento y la igualdad*. ECLAC, Santiago, Chile.
- \_\_\_\_\_ (2010b), *Monitoring of the Plan of Action eLAC2010: Advances and challenges of the information society in Latin America and the Caribbean, 2010*, ECLAC, Santiago, Chile.
- Fern ndez, Pablo (2010), "Youtube present  su versi n argentina," *La Naci n de Argentina*, September 8, 2010, [online] <[http://www.lanacion.com.ar/nota.asp?nota\\_id=1302523](http://www.lanacion.com.ar/nota.asp?nota_id=1302523)>, [Retrieved on: October 5, 2010].
- Fosk, Alejandro (2010), "Estado de Internet en Latinoam rica", *comScore* [presentation] comScore Webinar, [online] < [http://www.comscore.com/esl/Press\\_Events/Presentations\\_Whitepapers/2010/State\\_of\\_the\\_Internet\\_in\\_Latin\\_America](http://www.comscore.com/esl/Press_Events/Presentations_Whitepapers/2010/State_of_the_Internet_in_Latin_America)>, June 15, 2010.

- Fundación Telefónica (2008), *La generación interactiva en Iberoamérica*, Fundación Telefónica, Madrid, Spain.
- IDC (2010), “Latin America Predictions 2010”, IDC, [presentation] IDC Executive Webinar, [online] <<http://www.idclatin.com/campaign/predictions/pdf/LAPredictions2010.pdf>>, January 20, 2010.
- Kholod, Alexandre y John Lewis (2010), “The digital dividend: opportunities and challenges,” *ITU News Magazine*, Vol. No. 1, January.
- León, Omar de (2010), *Panorama de la Banda Ancha en América Latina*, División de Desarrollo Productivo y Empresarial, ECLAC, Santiago, Chile.
- Nixon, Patrick (2010) “Ericsson cree que Backhaul debe crecer 100 veces para tener 5.000 millones de equipos el 2020,” *Business News Americas*, July 6, 2010, [online] <[http://www.bnamericas.com/news/telecomunicaciones/Ericsson\\_cree\\_que\\_Backhaul\\_debe\\_crecer\\_100\\_veces\\_para\\_tener\\_5,000\\_millones\\_de\\_equipos\\_el\\_2020/194809930](http://www.bnamericas.com/news/telecomunicaciones/Ericsson_cree_que_Backhaul_debe_crecer_100_veces_para_tener_5,000_millones_de_equipos_el_2020/194809930)>, [Retrieved on: July 7, 2010].
- Peres, Wilson y Martin Hilbert (2009), *La sociedad de la información en América Latina y el Caribe, desarrollo de las tecnologías y tecnologías para el desarrollo*, ECLAC, Santiago, Chile.
- Said Business School, University of Oxford and University of Oviedo (2009) “Broadband Quality Score. A global study of broadband quality”, CISCO, [online] <[http://www.sbs.ox.ac.uk/newsandevents/Documents/Broadband%20Quality%20Study%202009%20Press%20Presentation%20\(final\).pdf](http://www.sbs.ox.ac.uk/newsandevents/Documents/Broadband%20Quality%20Study%202009%20Press%20Presentation%20(final).pdf)>, [Retrieved on: September 25, 2010].
- Salvador, Omar (2009), “Smartphones in Latin America: Big Opportunities for Operators and Suppliers”, *Pyramid Research*, Latin America Telecom Insider Vol. 1 No. 5, June.
- Subsecretaría de Telecomunicaciones de Chile (2009) “Encuesta Nacional de Consumidores de Servicios de Telecomunicaciones, Primer Semestre 2009”, *Ministerio de Telecomunicaciones*, Santiago, Chile, August.
- Temboury, Mercedes (2010) “Banda ancha móvil: tendencias en América Latina”, *ENTER-IE*, Nota ENTER-IE 61, April 12, 2010, [online] <<http://www.enter.es/cms/es/informe/9740/1>>, [Retrieved on: September 15, 2010]
- Vanier, Fiona (2010) “World Broadband Statistics, Q4 2009”, *Point Topic*, London, March.
- Yongsoo, Kim, Tim Kelly and Siddhartha Raja (2010), *Building broadband: strategies and policies for the developing world*, World Bank, June 22, 2010, [online] <[http://publications.worldbank.org/index.php?main\\_page=product\\_info&products\\_id=23841](http://publications.worldbank.org/index.php?main_page=product_info&products_id=23841)>, [Retrieved on: July 20, 2010].

## **IV. The broadband divide as a rapidly moving target**

Priscila López and Martin Hilbert

### **A. Capacity for digital communications over the Internet**

This chapter discusses the dynamic evolution of the Internet in terms of the number of subscribers and the corresponding communications capacity as measured in bits and bytes. We apply the methodology presented in Hilbert and López (2011a) and estimate digital communications capacity, which we basically obtain by multiplying the number of subscribers by the bandwidth of each subscription in kbit/s (upstream and downstream transmission rate). This latter variable reflects the most commonly used performance rates, not the theoretical maximum speeds of the technology. In a departure from Hilbert and López (2011a), in the present exercise we do not normalize on compression rates and focus on the installed hardware capacity in kbit/s, rather than actual usage rates (for other exercises of this nature, see Hilbert and López, 2011b-f).

The fixed Internet access technologies considered in this study include dial-up, ISDN (Integrated Service Digital Networks) with basic (BRI) and primary (PRI) access, cable modem, DSL (digital subscriber line), FTTH/B (fibre to the home/building) and “other/unidentified” technologies. The latter category includes subscribers using wireless access technologies such as WiFi, fixed WiMAX, satellite, microwave or electric wiring as well as those with wireless or fixed Internet subscriptions that use unspecified technologies; the lack of specification was a factor in the early years of this study and also arises in some cases in developing countries due to a lack

of available statistics.<sup>1</sup> To measure the actual performance of DSL, cable modem and other broadband technologies, we calculate an estimate based on the average national bandwidth reported by NetIndex (Ookla, 2010).<sup>2</sup> In addition, we calculate an estimate for the bandwidth capacity for mobile data traffic (including mobile Internet and SMS) over the following technologies: 2G (GSM, cdmaOne, PDC, TDMA, iDEN); 2.5G (GPRS, EDGE); and 3G (WCDMA (UMTS), CDMA2000 1x, CDMA2000 1xEV-DO). The data used for this purpose are from ITU (2010) and have been supplemented by other sources (see the supporting online material in López and Hilbert, 2010a).

In the following sections, we present two kinds of analyses. The first focuses on worldwide communications capacity, while the second compares the scenarios for the OECD member countries (“developed countries”) and for Latin America and the Caribbean. In both sections, the presentation is structured in the same way. We start with an overview of the types of subscriptions and then look at the corresponding communications capacity. We then draw three general conclusions, all of which emerge from the analysis.

## **1. Worldwide capacity**

### **(a) Subscribers**

Although the Internet’s beginnings can be traced back to the 1960s, it was not until the early 1990s—with the development of the World Wide Web and HTML and the introduction of browsers—that the real potential of this technology began to be exploited. Commercial Internet service first became a reality in 1989 when the first Internet service providers (ISPs) began to offer residential dial-up and ISDN subscriptions (The History of Computing Project, 2007; McDowell, 2010; Pearson Education, 2007). From that point in time, it took only four years to reach 50 million users, compared to 74 years to reach the same number of telephone subscribers (Goleniewski and Wilson, 2006).

---

<sup>1</sup> In practical terms, this category basically corresponds to the difference between the total number of subscribers to fixed Internet access technologies and the sum of subscribers to all the technologies mentioned above, except ISDN.

<sup>2</sup> NetIndex compiles the results of two connection speed measurements (Speedtest.net and Pingtest.net) upon which the average uplink and downlink rates are estimated for 164 countries starting from 1 January 2008 (for a total of 7,455,976 speed tests). In this chapter, for reasons of technical precision, the terms “upstream” and “downstream” are used for both wireless and wired technologies.



Figure IV.1 shows how the distribution of the worldwide subscriber base for fixed and mobile Internet (mobile data, including 2G, with SMS/fax) has evolved. In 1993, dial-up and ISDN-BRI were being used by 85% of all subscribers, as was also the case in 2000, while broadband technologies (ISDN-PRI, DSL and cable modem) accounted for only 7%. In 2005, the number of broadband subscribers surpassed the number of users of dial-up, and this trend had strengthened further by 2007, when dial-up represented 19% of the total (ISDN-BRI, 5%), while the above broadband technologies (not including those in the “other” category) accounted for over 50%. The data clearly reflect a technology-substitution process in which new subscribers preferred broadband technologies over lower-performing technologies (dial-up and ISDN).<sup>3</sup> In overall terms, the number of fixed Internet subscriptions increased from 5 million in 1993 to 209 million in 2000 and 648 million in 2007.

Meanwhile, data transmission via cellular phones has increased much more sharply. In 1993, there were only 1.4 million subscribers worldwide; in 2000 there were 650 million; in 2007, some 3.4 billion (i.e., five times the number of subscriptions to fixed Internet). Figure IV.1 also illustrates the shift from second-generation technology (2G) in 1993 and 2000 (when it represented 100%) to 2.5G (75% in 2007) and 3G (17% in 2007).

Figure IV.1  
**Distribution of fixed and mobile technology subscribers worldwide  
in 1993, 2000 and 2007**  
(Number of subscribers and percentages)

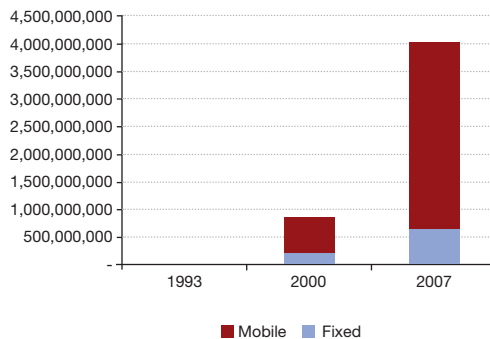

(continued)

<sup>3</sup> ISDN-PRI technology, which has primarily been used by companies for data transmission, was considered to be a broadband technology in the 1990s, as it performed six times better than ISDN and 14 times faster than dial-up.

Figure IV.1 (concluded)

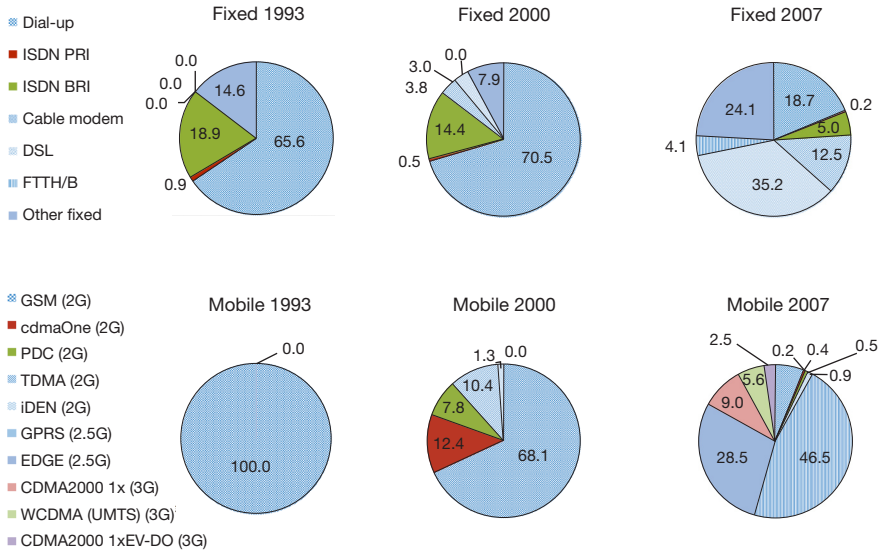

Source: Prepared by the authors on the basis of ITU (2010) López and Hilbert (2010).

DSL is the most successful broadband access technology in terms of the number of subscribers and has outdistanced other technologies such as cable modem and FTTH/B (fibre to the home/building). In 2007, DSL accounted for 35% of all subscribers, cable modem for 13% and FTTH/B for only 4%.

**(b) Transmission capacity**

Figure IV.2 presents information on how each technology contributes to total capacity, defined as the sum of downstream and upstream transmission capacities. It is important to point out that, for the purposes of the analysis presented in this chapter, capacity is measured in kbit/s, which is based on the average performance of a particular device (for example, dial-up 56 kbit/s downstream and 48 kbit/s upstream). In fact, the network infrastructure would not support the use of all devices at the same time if they were operating at their maximum advertised capacity (an effect that can be witnessed at midnight on New Year’s Eve in the case of the mobile phone network, for example). According to our estimates for 2007, the advertised fixed and mobile bandwidth potential is some 170 times greater than the real installed capacity worldwide. The fact that demand for a shared bandwidth in the packet-based networks is not simultaneous is what makes it possible to exploit economies of scale in

shared backbone networks. In this exercise, we look at the potential maximum bandwidths (compare with Hilbert and López, 2011e).

The following figure shows an approximation of the distribution of the contributions of different technologies to global traffic. Clearly, broadband technologies have been responsible for the lion’s share of capacity from 2002 onward. The reason for this is brought out clearly by a comparison between the average performance of a dial-up connection (downstream/upstream rates of 56/48 kbit/s) and a DSL connection (3,500/1,000 kbit/s in Europe), a cable modem connection (up to 7,000/2,000 kbit/s in Europe) or an optical fibre FTTH/B, which was expected to reach between 14,000/2,200 kbit/s in Europe and 30,000/30,000 kbit/s in Japan and the Republic of Korea (all for the year 2007).

While mobile telephony accounts for the vast majority of subscribers to digital technologies in the world, its contribution to global data transmission capacity is relatively small. A 2G mobile phone has a downstream/upstream performance of 14/14 kbit/s (2G GSM), while a 2.5G phone has one of 100/42 kbit/s (EDGE) and 3G phones have a performance level of 350/350 kbit/s (UMTS), all of which are much lower than fixed Internet transmission rates..

Figure IV.2  
**Worldwide transmission capacity, by technology**  
*(kbit/s)*

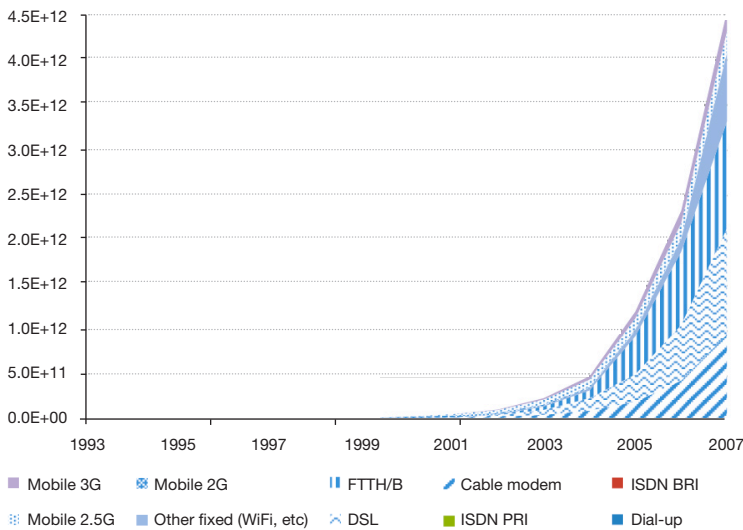

Source: Prepared by the authors.

For a more detailed analysis, figure IV.3 shows each technology's contribution to total capacity. In 1993, dial-up and ISDN BRI/PRI accounted for the bulk of capacity, representing 20% and 67% of the total, respectively, while SMS text messaging services on mobile phones already represented 8%. It is instructive to compare figure IV.3 with figure IV.1. The most notable case is ISDN-PRI, which, with less than 1% of the subscribers, represented 15% of total capacity at that time. In 2000, the same technologies were still the most important (dial-up with 29% and ISDN BRI/PRI with 21%). The boom in 2G phones was remarkable: with only 14/14 kbit/s downstream/upstream transmission capacity, they represented 38% of world data communications capacity. DSL and cable modem accounted for only 4% and 5%, respectively, of the total capacity of the Internet. This situation had changed dramatically by 2007, when ISDN and dial-up represented less than 1%, while FTTH/B, which had been an insignificant technology in 2000, accounted for 26% of total world capacity, even though its subscriber base amounted to only 4% of all fixed Internet subscribers. DSL, cable modem and the other access technologies represented almost half of global capacity (47%). While mobile subscribers accounted for the fastest-growing segment in terms of subscriptions (see figure IV.1), mobile telephony's contribution to advertised bandwidth capacity has been decreasing in recent years. Despite the introduction of 2.5G and 3G networks in 2001-2007, mobile technologies' contribution has shrunk from 38% to 10%.

Figure IV.3  
**Distribution of worldwide capacity, by fixed and mobile technologies, in 1993, 2000 and 2007**  
*(Percentages)*

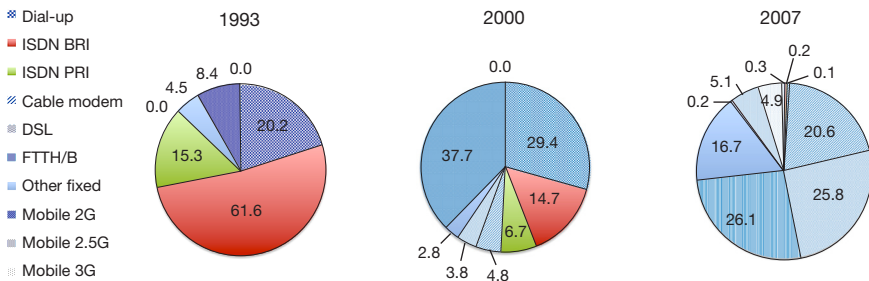

Source: Prepared by the authors.

The growth of total capacity stems from two sources: the growing number of subscribers (network expansion) and technological progress (the expanding capacity of the links that make up the networks). Figure IV.4

shows the contribution of each of these variables ([growth factor of fixed and mobile subscribers] x [growth factor of technical progress in fixed and mobile technologies] = [growth factor of capacity]). Up until 2001, the increase in the number of subscribers outpaced technological progress. During these early years of digital technologies, investment in the expansion of telecommunications networks dominated the agenda for increasing global communications capacity. This situation started to reverse itself in 2002, when bandwidth, rather than the number of connections, began to define communications capacity. This indicates that, the expansion of mobile telephony notwithstanding, the popularization of broadband technologies was the variable that contributed the most to the growth of total world communications capacity between 2001 and 2007. The expansion of network infrastructure has played a less important role in recent years.

Figure IV.4  
**Growth factor of the number of fixed and mobile subscribers and technological progress**

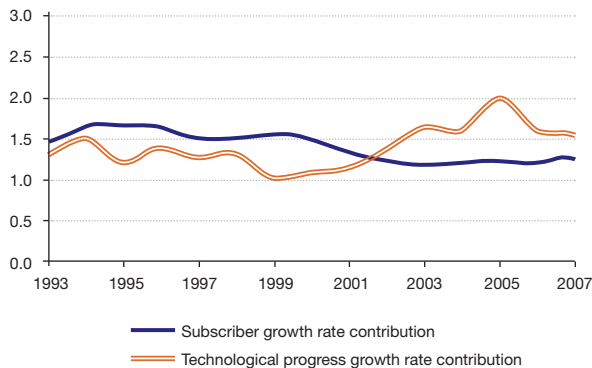

Source: Prepared by the authors.

Note: The growth factor for a given year is calculated as the ratio between the value of a variable for that year and its value in the preceding year.

The figure also shows that the pace of subscriber growth remained relatively constant between 2002 and 2007, while technological progress exhibited a great deal of variation. This can be attributed to continuing increases in the performance of DSL technologies, cable modem, FTTH/B and the others.

An analysis of the growth rates of upstream and downstream capacities indicates that they were constant up until 1997 and that the Internet was a symmetric communications medium having the same transmission rate in both directions (see figure IV.5). This changed with the introduction of broadband, which is generally asymmetric. The result was an increase in the gap between downstream and upstream rates. Since 2000, capacity has grown at uneven rates

in both directions. For the most part, although the upstream rate has increased, it has grown more slowly than the downstream rate. This is because, typically, Internet users downstream more data than they upstream. Nevertheless, in recent years, with blogs, virtual photo albums, YouTube, video conferencing and VoIP, among others, upstream speed requirements have increased and service providers have responded to this need. Their response was particularly notable in 2004-2006, when a significant upturn was recorded. In technological terms, this increase was spurred, in particular, by the introduction of FTTH/B and the fact that some countries offer symmetrical FTTH/B services.

Figure IV.5  
Growth factor of installed upstream and downstream capacity

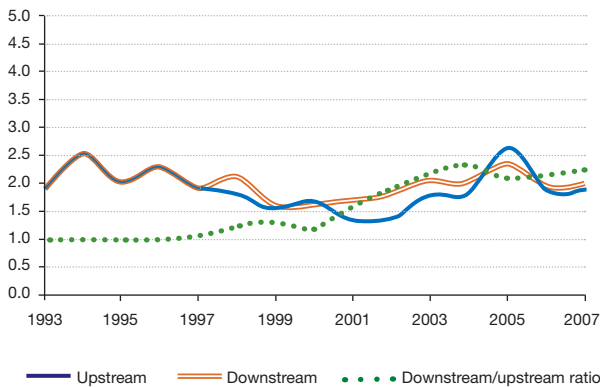

Source: Prepared by the authors.

### (c) Fixed Internet bandwidth in 2007

We will now look at the distribution of subscribers and transmission capacity across countries. The following analysis focuses exclusively on fixed Internet and therefore does not take account of the bandwidth provided by mobile phones (as already explained, fixed technologies dominate digital communications capacity). Figure IV.6 shows that just seven countries (Japan, the Russian Federation, the Republic of Korea, the United States, China, Germany and France) possess 85% of total potential Internet bandwidth worldwide, with 65% of the subscriptions. A comparison of Japan and the Republic of Korea with China illustrates the importance of bandwidth. The first two represent 40% of global capacity, although they have only 8% of all Internet subscriptions. On the other hand, China, with a quarter of the world's subscribers, accounts for only 11% of global communications capacity.

Figure IV.6  
**Distribution of subscribers and utilized fixed Internet capacity, by country, 2007**  
 (Percentages)

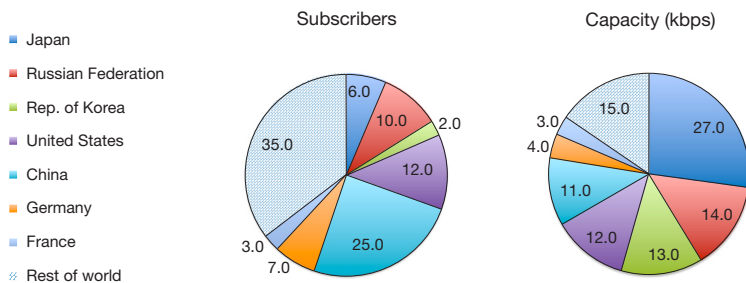

Source: Prepared by the authors.

Japan and the Republic of Korea achieved this level of development through initiatives such as e-Japan 2001 (IT Policy, Japan, 2001; IT Strategy Headquarters, Japan, 2001), e-Korea Vision 2006 and Broadband IT Korea Vision 2007 (Informatization Promotion Committee, 2007). These programmes share the common aim of making these two countries the most modern nations in the world in terms of ICT use. Both countries have clear-cut strategies for achieving that goal. In terms of infrastructure, the core strategy consists in modernizing Internet access via fibre optics technologies. FTTH/B is, thus far, the technology that makes the highest transmission rates available to users (currently there are Internet service providers offering up to 1 Gbit/s symmetrical). This connection speed is of key importance in running certain critical bandwidth-heavy services, such as advanced and user-friendly e-health and e-education applications and teleconferencing (including multiparty video conferencing and other interactive online applications).

Figure IV.7 illustrates how Internet access in Japan has evolved. For 1993 and 2000, the situation was very similar to the global one: ISDN and dial-up completely dominated the market, and higher bandwidth technologies represented only 3% of subscribers and 6% of capacity utilization. However, in 2007, DSL, cable modem and FTTH/B market shares all expanded, loosening the hold of ISDN dial-up, which fell to 27% of total subscribers and a negligible 0.1% of capacity. FTTH/B has been the most significant force driving the change, as demonstrated by the fact that in 2007 it accounted for 66% of capacity and 31% of all subscribers.

Figure IV.7  
**Distribution of subscribers and utilized fixed internet capacity in Japan in 1993, 2000 and 2007**  
*(Percentages)*

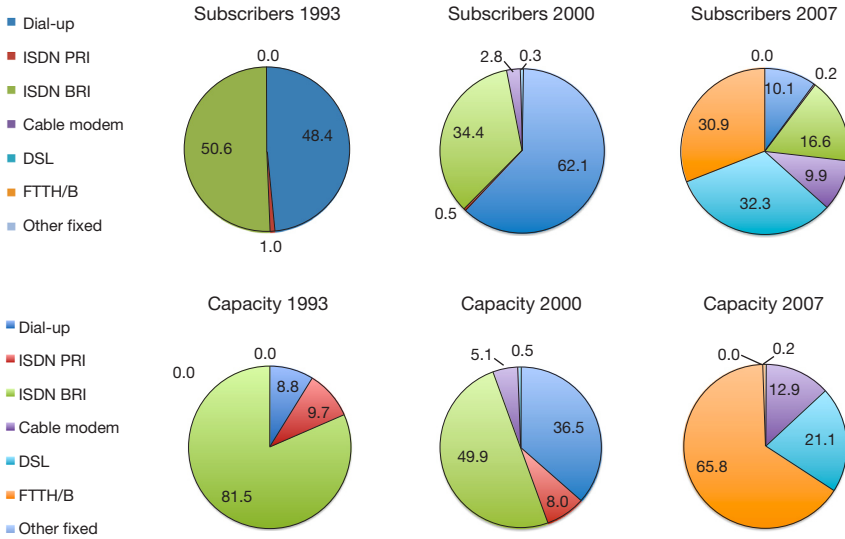

Source: Prepared by the authors.

The case of the Republic of Korea is even more surprising, given the speed with which broadband technologies (particularly cable modem, FTTH/B and DSL) became subscribers' preferred access technologies (see figure IV.8). In 1993, dial-up accounted for 90% of subscriptions and 52% of capacity (47% for ISDN-BRI) but, by 2000, 48% of subscribers had DSL, 25% had cable modem and 19% had dial-up, and these technologies accounted for 57%, 29% and 7%, respectively, of capacity. Having nearly 75% of subscribers using technologies of higher bandwidth just a few years into its deployment was not a trend shared by other countries (worldwide it was just 9%). In 2007, the lower-bandwidth technologies accounted for 2% of subscribers and a near zero percentage of capacity, while FTTH/B represented 57% of capacity, even though it accounted for only 34% of subscribers.



Figure IV.8  
**Distribution of subscribers and utilized fixed internet capacity in the Republic of Korea in 1993, 2000 and 2007**  
*(Percentages)*

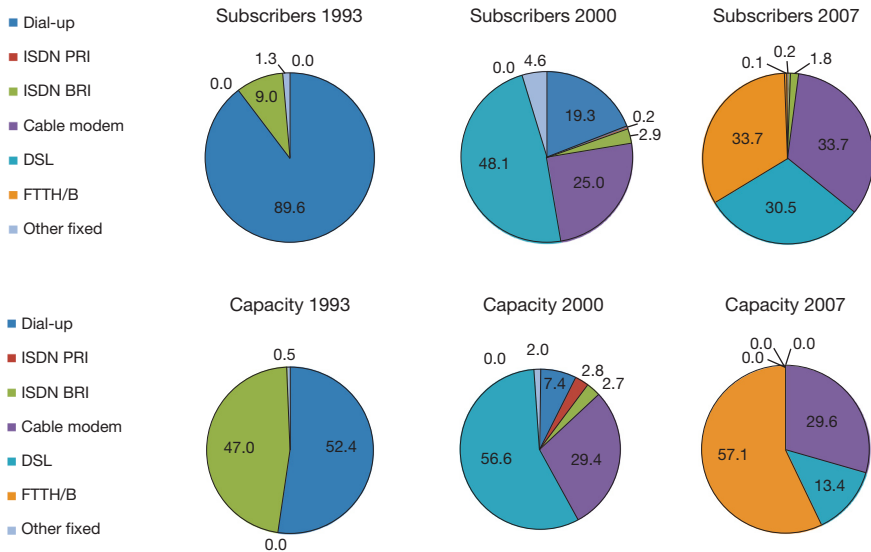

Source: Prepared by the authors.

All of the above data lead to a clear and unequivocal conclusion: the widespread use of FTTH/B is why Japan and the Republic of Korea accounted for 40% of global capacity for the transmission of information over the network of networks in 2007. OECD data (2010) suggest that the situation has not changed significantly since then. According to the data provided in figure IV.9, these countries continued to be the leading access providers via fibre optics in 2009: Japan with 54% of subscribers using FTTH/B and the Republic of Korea with 49%, followed by the Slovak Republic and Sweden with 28% and 23%, respectively, while the rest of the countries have a penetration rate of less than or equal to 11%.

Figure IV.9  
**FTTH/B connections as a percentage of total broadband subscribers in OECD countries, December 2009**  
 (Percentages)

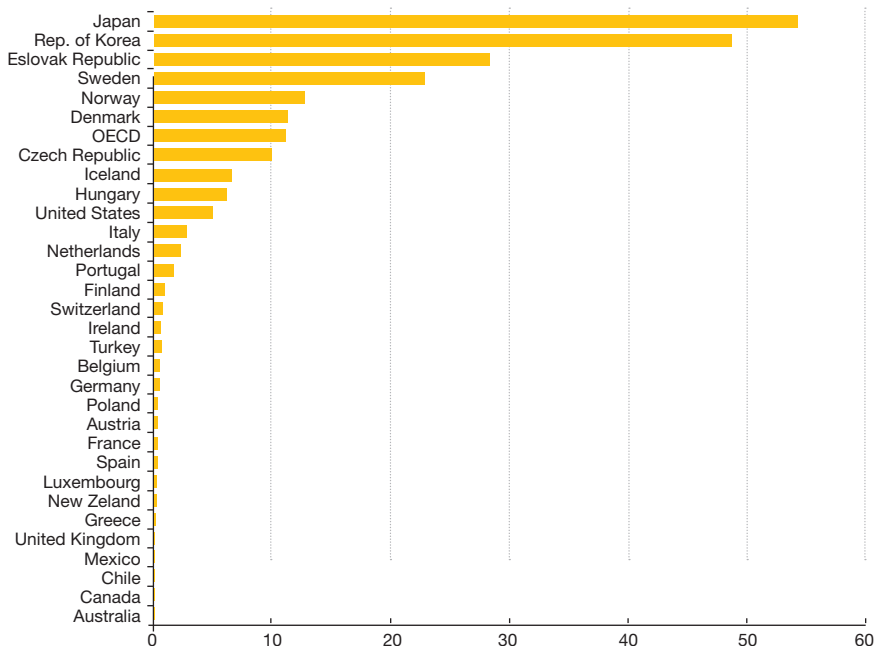

Source: OECD broadband portal, *Percentage of fiber connections in total broadband* (December 2009), 2010.

Figure IV.10 presents available FTTH/B coverage in the OECD countries, i.e., the number of households that could be served; Japan and the Republic of Korea remain the most prominent. The other OECD countries lag behind these front runners in terms of the deployment of infrastructure, and this becomes all the more clear when one considers that the data presented for the two leading countries correspond to the end of 2008.<sup>4</sup> The situation in Latin America is even less auspicious. From 2005 to 2007, Chile and Brazil were the only countries offering residential service, with symmetrical transmission rates of 100 Mbit/s and 30/5 Mbit/s, respectively. The statistics that would be needed in order to accurately estimate capacity in the region were not available at the time of writing, but the region's capacity was most likely very limited compared to OECD countries.

<sup>4</sup> Only the data for Denmark, Finland, France, Germany, Hungary, Iceland and the United States correspond to the coverage in mid-2009; for the other countries, the data correspond to the end of 2008.

Figure IV.10  
**FTTH/B coverage in households in OECD countries**  
 (Percentages)

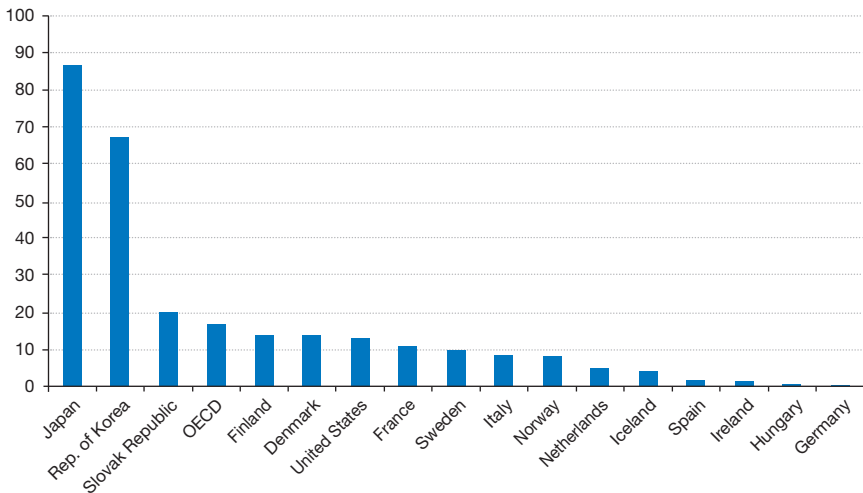

Source: OECD broadband portal, *FTTH/B coverage (up to 2009)*, 2010

## 2. *The communication capacity gap between the OECD countries and Latin America and the Caribbean*

How does Internet communication capacity in Latin America and the Caribbean compare with that of the developed world? To answer this question, the following section reviews the distribution of subscribers throughout the 30 OECD member countries (1.184 billion people in 2006),<sup>5</sup> which may be regarded as “developed” economies), along with 37 developing countries in Latin America and the Caribbean (456 million inhabitants)<sup>6</sup> and the rest of the world.

<sup>5</sup> Australia, Austria, Belgium, Canada, Czech Republic, Denmark, Finland, France, Germany, Greece, Hungary (as from 1996), Iceland, Ireland, Italy, Japan, Republic of Korea (1996), Luxembourg, Netherlands, New Zealand, Norway, Poland (1996), Portugal, Slovak Republic (2000), Spain, Sweden, Switzerland, Turkey, United Kingdom and United States; Mexico has been an OECD member since 1994, but is included in the category of non-OECD Latin American countries in the figures dealt with in this chapter.

<sup>6</sup> Antigua and Barbuda, Argentina, Aruba, Bahamas, Barbados, Belize, Bermuda, Plurinational State of Bolivia, Brazil, Chile, Colombia, Costa Rica, Cuba, Dominica, Dominican Republic, Ecuador, El Salvador, French Guiana, Grenada, Guatemala, Guadeloupe, Guyana, Haiti, Honduras, Jamaica, Martinique, Netherlands Antilles, Nicaragua, Panama, Paraguay, Peru, Saint Kitts and Nevis, Saint Lucia, Saint Vincent and the Grenadines, Suriname, Trinidad and Tobago, Uruguay and Bolivarian Republic of Venezuela.

### (a) Subscribers

The share of total fixed Internet subscribers residing in OECD member countries has been declining steadily (from 94% of the total in 1993 to 51% in 2007), while the share of the rest of the world has increased nearly 10 times over in 15 years (from 5% in 1993 to 46% in 2007). Latin America and the Caribbean, meanwhile, increased their presence from 0.8% in 1993 to 2.7% in 2000, with another jump to 3.2% in 2007. The outlook for mobile telephony is brighter, with the region representing 9.2% of subscriptions in 2007, which is slightly greater than its 8.5% share of the world population (see figure IV.11). Adding together the two technologies (fixed Internet access and mobile telephony), the region's share of the total number of subscribers rose from 0.5% in 1993 to 4.4% in 2000 and almost doubled to 8.2% in 2007.

Figure IV.11

#### Distribution of fixed and mobile subscribers in OECD countries, Latin America and the Caribbean, and the rest of the world in 1993, 2000 and 2007 (Percentages)

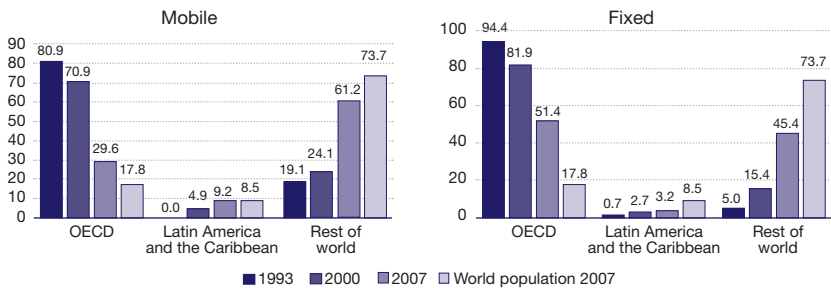

Source: Prepared by the authors on the basis of data from ITU (2010).

A comparison of the distribution of subscribers to the various fixed Internet technologies in OECD countries and in Latin America and the Caribbean (see figure IV.12) shows that dial-up dominated in both regions in 1993. In that same year, in OECD countries, ISDN/BRI already had 20% of the subscribers, while its use in Latin America and the Caribbean was marginal. In 2000, the situation was similar, but in the OECD countries, subscribers to broadband access represented 8% of the total (3.3% for DSL and 4.4% for cable modem), while, in the region, the figure was only 3% (1% for DSL and 2% for cable modem). Finally, in 2007, both regions registered a similar distribution in general terms (less than 20% of subscribers had dial-up and the rest had higher bandwidth services), but the difference lay in the distribution of broadband technologies in terms of overall broadband access. In the OECD countries, 6% was FTTH/B, 44% DSL and 21% cable modem, while, in Latin America and the Caribbean, 54% was DSL, 19% cable modem and there were no available statistics for FTTH/B.

Figure IV.12  
**Distribution of fixed internet subscribers in OECD countries and Latin America and the Caribbean in 1993, 2000 and 2007**  
*(Percentages)*

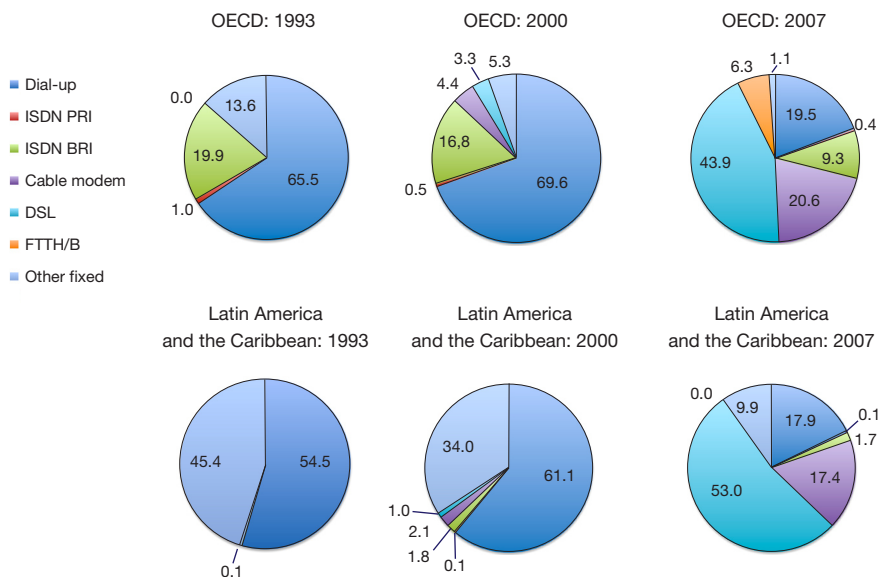

Source: Prepared by the authors on the basis of data from ITU (2010).

### (b) Utilized capacity

Overall, the regional distribution of total global capacity is similar to the distribution of subscribers: the OECD share decreases as capacity increases around the world (led by China and the Russian Federation). The Latin American and Caribbean region's share of fixed Internet communications capacity was on the rise until 2000, when it reached 2% of world capacity, before declining sharply between 2000 and 2007. Compared with the Latin American and Caribbean region's share in the global economy, Internet hardware capacity in the region still lags behind. Although Latin America and the Caribbean represent 8.5% of the world population and 4.8% of global GDP, the region's fixed Internet communications capacity is eight times less (0.6%). In other words, if Latin America and the Caribbean can be classified as a developing region in terms of economic power, it must nevertheless be classified far below "developing" in terms of its fixed-line Internet-based communications capacity.

The Latin American and Caribbean region’s share of mobile telephony is much more significant and, at 7% of global transmission capacity for mobile data in 2007, is somewhat greater than its weight in the global economy. Nonetheless, given the relative weight of fixed Internet in data communications via mobile telephony, especially in recent years (see figure IV.13), the part played by the region in the overall picture has diminished a great deal. When the two technologies are added together, the region’s share of transmission capacity rose from 0.2% in 1993 to 2.9% in 2000 before falling back sharply to 1.1% in 2007.

The temporary increase in the Latin American and Caribbean region’s share of the mobile telephony market is accounted for by the mass dissemination of this technology and the fact that, at least until 2007, there was no significant gap in the performance of different data communication technologies for mobile devices: a 2G phone operated with downstream/upstream speeds of 14/14 kbps (SMS for GSM) in Brazil, as well as in Germany, and a 2.5G phone operated at a speed of 100/42 kbps (EDGE), regardless of where it was used. This is not the case with fixed-line Internet, where the capabilities offered by DSL and cable modem are quite different in the developed and developing worlds. It is not clear if the supply of uniform bandwidth capacities in the mobile world will remain as it has been after the transition to 3G and 4G phones

Figure IV.13  
**Distribution of fixed and mobile capacity in OECD countries, Latin America and the Caribbean, and the rest of the world in 1993, 2000 and 2007**  
*(Percentages)*

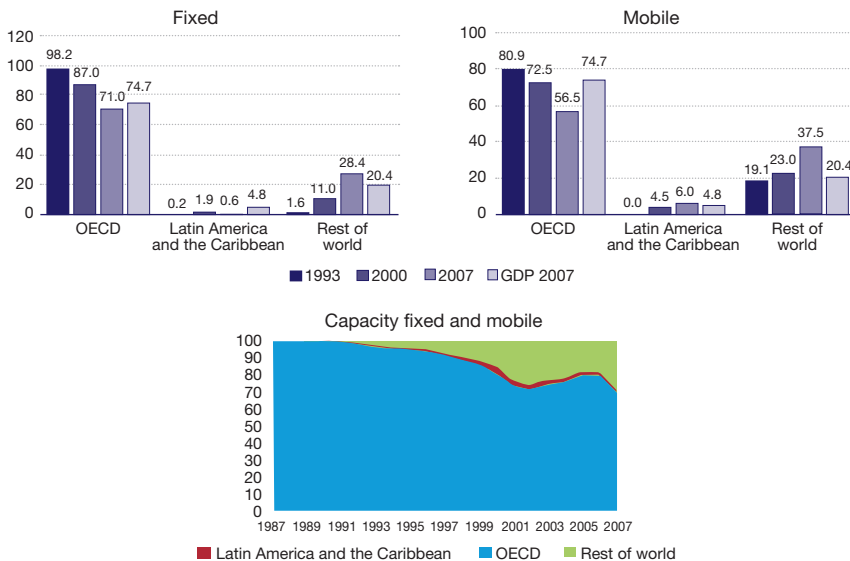

Source: Prepared by the authors.

Figure IV.14  
**Distribution of capacity in OECD countries and Latin America and Caribbean in 1993, 2000 and 2007**  
 (Percentages)

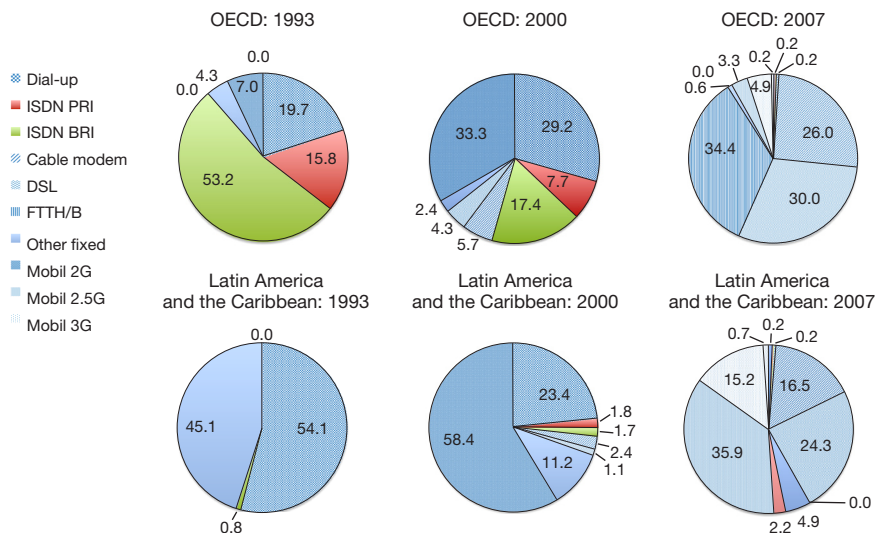

Source: Prepared by the authors.

The distribution of technologies depicted in figure IV.14 indicates that, in OECD countries, dial-up and ISDN (BRI and PRI access) reigned supreme in 1993, accounting for over 89% of capacity (53% of which corresponded to ISDN-PRI, which suggests that the Internet was being used mostly by businesses and organizations). In 2000, higher bandwidth technologies (DSL and cable modem) represented 10%, and dial-up dropped to 29%; 2G mobile telephony represented the largest share of digital communications capability in 2000 (33%), but then lost that leadership position due to the popularization and advance of broadband. In 2007, FTTH/B had the largest share of the total capacity of OECD countries at 34%, while DSL and cable modems accounted for 26%. The contribution of 2.5G and 3G telephony fell to 8.2%.

The situation in Latin America and the Caribbean evolved in a similar -- although more extreme-- manner, and mobile telephony continued to dominate in 2007. In 1993, dial-up was the dominant technology, and there were no digital mobile phones. By 2000, 2G telephony accounted for more than half of total use (58%). Broadband technologies with higher bandwidths (DSL and cable modem) represented only 3.5% of use in 2000. In 2007, mobile phones continued to dominate with 3G (15%) and 2.5G (36%) technologies. DSL and

cable modems accounted for 41%. This configuration explains the region's low level of participation in the fixed Internet world, especially considering that generally higher bandwidth technologies have greater capacity in more developed countries. For example, according to estimates based on NetIndex (Ookla, 2010), a DSL connection in Europe had a downstream/upstream speed of 3520/1050 kbps in 2007, while in the region it was only 980/280 kbps for the same technology.

Naturally, the next question is whether the gap in digital communications capacity between the Latin American and Caribbean region and OECD is narrowing. As expected, the gap in the number of subscribers is closing rapidly: the number of computers is still increasing in developing countries, while a saturation level has already been reached in the developed world. In 2000, there were 31 times more fixed Internet subscribers in the OECD countries than in Latin America and the Caribbean. In 2007, the figure was only 13 times more. In the case of mobile telephony, there were 14 subscribers in OECD countries for each user in the region in 2000; the difference was 3.2 to 1 in 2007. The gap in mobile communications capacity increased with the introduction of 2.5G and 3G in 2000-2004, but closed with the widespread distribution of 2.5G in the region in 2004-2007. The gap was 2.9 to 1 in 2007, which was very similar to the gap in the ratio of subscribers (see figure IV.15). In other words, there was no significant difference between developing and developed countries in terms of mobile telephony performance in 2007. The situation is different when it comes to fixed Internet, however, since the communications capacity gap has been increasing since fixed-line broadband was introduced.

Whereas, during the dial-up era, subscription performance began to converge and had evened out by 2002, the widespread introduction of DSL, cable modem and FTTH/B caused the gap in Internet communications capacity to widen again. In 2001, subscribers to fixed Internet services in OECD countries had, on average, 176 kbps at their disposal, compared to the average of 118 kbps available to subscribers in Latin America and the Caribbean (a gap of 1.5). Meanwhile, in 2007, a typical subscriber in developed countries had 7.4 times more capacity than a fixed Internet subscriber in Latin America and the Caribbean (8,705 kbps versus 1,179 kbps). As mentioned earlier, it is expected that this kind of gap will also be seen in mobile telephony with the move towards 4G networks, in which mobile telephony and fixed wireless Internet converge.



Figure IV.15  
**Comparison between OECD and the Latin American and Caribbean region:  
 number of subscribers and utilized capacity**  
*(Ratio: OECD/LAC)*

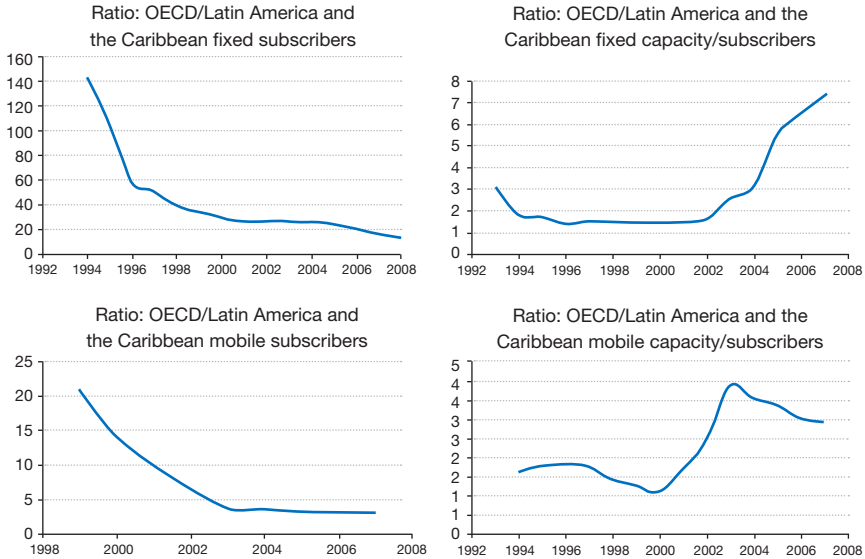

Source: Prepared by the authors on the basis of information from ITU (2010).

Note: LAC: Latin America and the Caribbean.

The likelihood of this outcome is confirmed by an analysis of the contributions to total digital media capacity made by increases in the number of subscribers and by technological progress as reflected in the performance of communications devices in the two regions. Such an analysis points up the declining influence of subscriber growth in the two regions up to 2002 and, as an offset, the greater contribution made by technological progress to total communications capacity (see figure IV.16). Both regions witnessed fluctuations in technological progress throughout this period as a result of technological shocks that ultimately led countries to move up to a higher level of performance. It is important to remember that, once a transition of this sort has been made, performance remains at the higher level, so while technological shocks are temporary, their long-term effect is not. In OECD, there have been two clear-cut technology shocks: one, around 2003, was largely based on the introduction of digital phones with greater communications capabilities, as well as advances in DSL and cable modem technologies; the other arose in 2005 with the introduction of FTTH/B. Technological progress in the Latin

American and Caribbean region has been much less pronounced. Higher bandwidth technologies (DSL and cable modem) were still contributing very little to total capacity in 2007 and FFTH/B was not yet available.

Figure IV.16  
**Growth factor of subscriptions and technological progress for total fixed and mobile internet in OECD countries and Latin America and the Caribbean**  
 (Percentages)

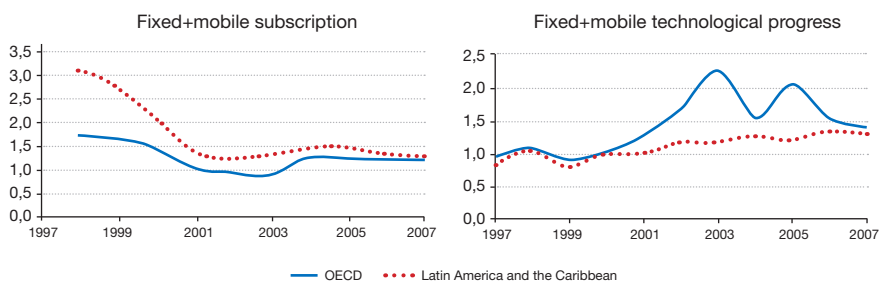

Source: Prepared by the authors.

## B. Three general conclusions

Based on the information presented here, three general conclusions can be drawn:

The first conclusion is methodological in nature. The information society and the digital divide must be considered not only in terms of “who has access” and “who does not” (number of devices, number of users), but also in terms of each person’s technological capacity to communicate (see also Hilbert, López and Vásquez, 2010). People in the vast majority of Latin American and Caribbean countries are already connected to digital networks, many of them through 2G and 2.5G mobile network connections, which at least allow symmetric data transmission with SMS at 14/14 kbit/s downstream/upstream (2G GSM), but households in Japan and the Republic of Korea have symmetric connections of 100,000 kbits/s. Viewing the situation from this standpoint, the fundamental question is not whether a person is connected or not, but *how* members of the information society are connected. Measuring the digital divide in terms of bandwidth no longer involves asking a “yes or no” question; rather, it has become a matter of gauging where countries or regions lie along a continuum, which currently ranges from 14 to 100,000 kbits/s. Research projects and related policies have to be designed to take account of this continuum, which, because

it is constantly being redefined by technological progress, is a rapidly moving target that has to be treated as such.

The second conclusion has to do with the unique nature of technological progress in telecommunications, inasmuch as, unlike other areas of technological progress, the “ultimate state of technological progress”, i.e., the limit of progress, is already known. In the field of transportation, for example, we do not have an ultimate technological solution for the fastest possible way of transporting people from one location to another. In the field of telecommunications, however, it is known, and has been known ever since Einstein, that the speed of light is the fastest possible way to communicate in this universe. In optical fibre systems, communication is carried out at the speed of light, as is communication via radio waves (less a certain percentage owing to refraction). There is no faster way to move information in this universe. It is also known that radio waves—although cheaper at this point in time—have a shorter range and are more susceptible to interference than optical fibre is. Thus, light-transmitting fibre optics will become the basic infrastructure of the information society and are being used to convey an increasing share of the total volume of data traffic (via more advanced and content-rich applications), while radio waves are used for dissemination in the “last mile”. This trend stands out clearly when we look at how communications have evolved in developed countries: in just six years (2001-2007), optical fibre communications began to dominate the Internet in the OECD countries (34%), while mobile telephony represented a complementary medium with a share of only 8%. Any effective policy in developing countries must be based on a recognition of these medium- and long-term situations, and the accompanying strategies must be designed accordingly.

The third conclusion stems from the fact that knowing what the ultimate goal is does not mean that the road to it can be travelled quickly, much less instantaneously. Many roads may lead to the same end point; the challenge is to find a path that allows us to recognize our current limitations and—without losing sight of the goal—to maximize resources in order to reach that goal in the most efficient manner possible. In Latin America and the Caribbean, mobile telephony plays an important role, but the region is losing ground in the race towards the moving target of technological progress and, as a result, may miss out on its chance to play a major part in the global information society. With the convergence of fixed and mobile networks (4G - with the convergence of mobile and fixed wireless networks), the deployment of an extensive fibre optic network can be expected to improve communications capacity over mobile networks. The current challenge is thus to plot out a practical and efficient path towards our goal of building an information society that is heavily based

on fibre optics (in the long term), while at the same time giving as many people as possible access to this infrastructure through low-cost solutions (in the short term). This approach involves finding ways to make communications technologies accessible to people, which requires a consideration of the relevant economic constraints, while also bearing in mind the demands of efficiency and remembering that, sooner or later, the gap with developed countries must be closed. To do so, strategies have to be devised that will allow the region to leapfrog towards the constantly moving target of the technological frontier. Japan and the Republic of Korea have demonstrated the effectiveness of thoroughly planned public-sector action in this respect. Limited resources may give rise to a trade-off between the objectives of widespread access and bandwidth quality. In the end, as always, dealing with this type of trade-off is a matter of public policy, rather than a technical issue. It is a question of the type of society that is to be created and is therefore a question that has to be addressed with broader policy objectives in mind.

## Bibliography

- Goleniewski, Lillian y Wilson J., Kitty (2006). *Telecommunications Essentials: The complete global source*. Addison Wesley Professional, 2nd Ed.
- Hilbert, Martin, Priscila López, y Cristian Vásquez, (2010). Information Societies or “ICT equipment societies”? Measuring the digital information processing capacity of a society in bits and bytes. *The Information Society*, 26(3). Retrieved from <http://www.indiana.edu/~tisj/inpress/3/ab-hilbert.html>
- Hilbert, Martin, y Priscila López. (2011a) “The World’s Technological Capacity to Store, Communicate, and Compute Information.” *ScienceExpress*, Science AAAS, 11. Febrero 2011. <http://www.martinhilbert.net/WorldInfoCapacity.html>. DOI: 10.1126/science.1200970 DOI
- \_\_\_\_\_. (2011b) “How to measure the world’s technological capacity to communicate, store and compute information? Methodological and statistical challenges for the social sciences”. *inédito*. <http://www.martinhilbert.net/WorldInfoCapacity.html>.
- \_\_\_\_\_. (2011c) “What drives the global growth of information? Peeking inside the black box of technological change in the digital age”. *inédito*. <http://www.martinhilbert.net/WorldInfoCapacity.html>.
- \_\_\_\_\_. (2011d) “The growing digital divide: Technological concentration and international distribution of society’s capacity to compute, store and communicate information”. *inédito*. <http://www.martinhilbert.net/WorldInfoCapacity.html>.
- \_\_\_\_\_. (2011e) “Mapping out the dimensions of technologically mediated communication: how much information is communicated by which medium?”. *inédito*. <http://www.martinhilbert.net/WorldInfoCapacity.html>.
- \_\_\_\_\_. (2011f) What is the content of the world’s technologically mediated information and communication capacity: how much text, image, audio and video?”. *inédito*. <http://www.martinhilbert.net/WorldInfoCapacity.html>.

- Informatization Promotion Committee (2006). *e-Korea Vision 2006*. (Assessed September 14, 2010). [http://www.ipc.go.kr/ipceng/policy/vision\\_2006.jsp](http://www.ipc.go.kr/ipceng/policy/vision_2006.jsp)
- \_\_\_\_\_. (2007). *Broadband IT Korea Vision 2007*. (Retrieved on: September 14, 2010). [http://www.ipc.go.kr/ipceng/policy/vision\\_2007.jsp](http://www.ipc.go.kr/ipceng/policy/vision_2007.jsp)
- IT Policy-Japan (2001). *E-Japan Priority Policy Program*. March 29, 2001. (Retrieved on: September 14, 2010). <http://www.kantei.go.jp/foreign/it/network/priority-all/index.html>
- IT Strategy Headquarters (2001). *e-Japan Strategy*. January 22, 2001. (Retrieved on: September 14, 2010). [http://www.kantei.go.jp/foreign/it/network/0122full\\_e.html](http://www.kantei.go.jp/foreign/it/network/0122full_e.html)
- McDowell, Heather (2010), "How to Test Dial-Up Speed". Last update: July 31, 2010. (Retrieved on: September 14, 2010) [http://www.ehow.com/how\\_6800254\\_test-dial\\_up-speed.html](http://www.ehow.com/how_6800254_test-dial_up-speed.html)
- OECD Broadband Portal (2010a). *Percentage of fibre connections in total broadband (December 2009)*. [http://www.OECD.org/document/54/0,3343,en\\_2649\\_34225\\_38690102\\_1\\_1\\_1\\_1,00.html](http://www.OECD.org/document/54/0,3343,en_2649_34225_38690102_1_1_1_1,00.html)
- \_\_\_\_\_. (2010b). *FTTH/B coverage (up to 2009)*. [http://www.OECD.org/document/54/0,3343,en\\_2649\\_34225\\_38690102\\_1\\_1\\_1\\_1,00.html](http://www.OECD.org/document/54/0,3343,en_2649_34225_38690102_1_1_1_1,00.html)
- Ookla (2010), *NetIndex: Source Data. Downlink and Uplink for 164 countries*, <http://www.netindex.com/source-data/>
- Peter, Ian (1999), "A Brief History of Pegasus Networks". (Retrieved on: September 14, 2010). [http://www.c2o.org/reports/Short\\_History\\_Internet\\_Aust.pdf](http://www.c2o.org/reports/Short_History_Internet_Aust.pdf)
- Pearson Education, Inc. (2007), *Internet Timeline*. (Retrieved on: September 14, 2010). <http://www.factmonster.com/ipka/A0193167.html>
- The History of Computing Project (2007), "Timeline, Chronology of the History of Computing Industrial Era." Last update: September 24, 2007, The History of Computing Project. (Retrieved on: September 14, 2010) <http://www.thocp.net/timeline/1989.html>



## V. Broadband tariffs: benchmarking and analysis

Hernán Galperin  
Christian Ruzzier

### A. Introduction

The price level of a service is a key variable for understanding how households and businesses arrive at a decision concerning that service's adoption and use. It also reflects the performance and the degree of competition within the corresponding sector and makes it possible to identify opportunities for regulatory action to strengthen competition and expand market boundaries. Very little research has been done, however, on the price levels for broadband Internet access services or on how they affect demand. This is even more so in the case of Latin America and the Caribbean, where even national broadband initiatives often lack a solid empirical foundation with regard to these kinds of price effects.

The lack of studies on this subject is due in part to methodological difficulties. First, governments and international agencies have only recently begun to collect data on the subject, and there are no standardized methods for comparing the multiplicity of plans and packages offered by service operators in different markets.<sup>1</sup> Second, the rapidly evolving nature of both fixed and mobile access technologies presents another challenge, and this is reflected in the multiple business models and service features offered by each operator. Finally, fragmentation into multiple markets at the local or regional level and looser regulatory controls than those applied to basic telecommunications

---

<sup>1</sup> For a discussion regarding the methodological options, see Wallsten (2009).

services make it difficult to establish market boundaries and to delimit the universe of service operators to be considered.

This chapter presents a first approach to analysing the price levels of broadband Internet access services in Latin America and the Caribbean and their effect on demand and penetration levels. This is a multidimensional approach to the broadband market that combines penetration levels (how many people or households have broadband), quality (service speeds offered by operators), price (how much users have to pay for the service) and affordability (how much this expenditure represents in terms of a household's or user's income).

In order to evaluate the performance of the countries in the region in terms of service penetration, this chapter employs a metric called the Broadband Performance Index (BPI). This index, developed following the work of Ford, Koutsky and Spiwak (2007) for OECD countries, takes a country's economic endowments into consideration in analysing the status of broadband development at the national level. In other words, the observed levels of penetration are compared with the predicted levels based on the country's economic resources and other characteristics that affect broadband adoption.

The analysis presented here of the service quality and price levels offered by the leading broadband providers in each country is based on a survey of plans and rates conducted by the authors during the second half of May 2010. The survey covered 323 service plans offered by 54 operators in 23 countries in the region. The data that were collected correspond to the capital or main city in each country, and the universe of operators includes, at a minimum, the leading provider of access via DSL (typically the former telecommunications incumbent) and the largest provider of services via cable modem (if there is one). In this first exercise, mobile broadband services were not included. Although several studies have underscored the importance of this platform for Internet access in the region, the inclusion of these services in the research would require a broader discussion about the complementarity or competition between fixed and mobile broadband, as well as metrics for comparing service quality levels, all of which goes beyond the scope of this paper.

The analysis of broadband affordability looks at observed rate levels and evaluates them in terms of the relation they bear to household income and willingness to pay for the service. This is a valuable tool for designing universal service plans which makes it possible to set realistic goals and to define appropriate policy instruments. Furthermore, disaggregation by income



group within each country makes it possible to arrive at a better approximation of the potential effect of rate reductions on service penetration among lower-income households and microenterprises.

Considering each of the dimensions of broadband services (i.e., penetration, price, quality and affordability) separately could lead to very different conclusions regarding the development of broadband in the countries of the region. The multidimensional approach taken in this chapter makes it possible to simultaneously analyse the different factors that determine the level of broadband development in each country, while also taking into account its economic endowments and demographic characteristics. In addition, this approach makes it possible to isolate the effect of the variables of interest to policymakers and to identify best international practices and opportunities for aligning public policy objectives with the policymaking tools available to governments in the region. Ultimately, the goal is to contribute to broadband development initiatives in Latin America and the Caribbean by offering recommendations regarding ways of channelling private investment, optimizing the use of public resources and maximizing the impact of universal service programmes.

The chapter is organized as follows: the second section discusses the Broadband Performance Index (BPI) and its results as compared to more traditional penetration indices. The third section presents the findings of the rate survey, while the fourth provides estimates of the effects of these rates on penetration levels in the region. The fifth section focuses on findings regarding the affordability of broadband services, while the conclusion outlines policy recommendations drawn from the analysis.

## **B. The broadband performance index**

The measurement most commonly used to establish the level of broadband development in a country is the service penetration rate, defined as the number of subscriptions per 100 inhabitants or households. The results obtained with this indicator are often predictable: wealthy, developed countries are also those with the highest levels of broadband penetration, while less developed countries lag behind in the deployment and adoption of this new technology. As argued by Ford et al. (2007), these results do nothing more than confirm the findings presented in an extensive body of literature which deals with the close relationship that exists between economic development and new technology adoption and, in particular, between

indicators of wealth and the deployment and use of telecommunications networks (known as the Jipp Curve).<sup>2</sup>

In this chapter, an alternative approach is used to compare broadband development across countries; for each country, observed penetration levels are compared to expected penetration levels based on a set of economic and demographic factors that previous studies have identified as determinants of the adoption and deployment of telecommunications infrastructure. In other words, rather than comparing countries on the basis of observed penetration levels (the traditional approach), the Broadband Performance Index (BPI) compares countries on the basis of how close they are to expected penetration levels given a set of economic and demographic characteristics that affect both supply and demand for broadband in a given market.<sup>3</sup> As such, this indicator is presented as a complement to traditional penetration indicators, rather than as a substitute.

To calculate the BPI, a simple regression model is estimated using five factors that have been identified in the literature as determinants of the level of broadband penetration (*PENET*):

- Per capita GDP in US dollars at purchasing power parity (PPP) (*GDPCAP*)
- Household density per square kilometre (*DENSHH*)
- Percentage of urban population (*POPURB*)
- Percentage of the population between 15 and 64 years of age (*AGE*)
- An education index (compiled by the United Nations) that measures the illiteracy rate and the rate of enrolment in primary, secondary and tertiary education (*EDUC*).

The observed penetration data correspond to 2009 and were obtained from the ITU database (ITU World Telecommunication Indicators ICT, 2010). Household density was calculated for 2008 by the authors based on the number

---

<sup>2</sup> For a general overview of this research, see the World Bank (2008).

<sup>3</sup> An example can be used to illustrate the use of the BPI. It is assumed that a single factor of wealth  $X$  determines broadband penetration  $B$  and that, on average, for every unit of  $X$ , broadband penetration increases by 0.10 units. Thus, the expected penetration in a country  $i$  would be  $B_i = 0.1 * X$ . Now, if the assumption is for two countries, A and Z, with wealth levels of 3 and 5, respectively, then the expected penetration would be 0.3 in country A and 0.5 in country Z. If it is found that the actual penetration is 0.35 in country A and 0.45 in country Z, it can be concluded that, although absolute levels of penetration are higher in Z, the level of broadband development is greater in country A when factor endowments are taken into account, while the broadband penetration in country Z is below its potential (Ford et al., 2007).

of households reported by ITU and the surface area of each country. All other variables refer to 2008 and were obtained from the World Bank (World Development Indicators database). The time lag in the explanatory variables is a consequence of the availability of data, but it can also mitigate potential endogeneity problems because, as shown by several studies, the development of broadband has an impact on aggregate GDP.<sup>4</sup>

The countries that will be analysed here are Argentina, Belize, the Plurinational State of Bolivia, Brazil, Chile, Colombia, Costa Rica, the Dominican Republic, Ecuador, El Salvador, Guatemala, Guyana, Honduras, Jamaica, Mexico, Nicaragua, Panama, Paraguay, Peru, Suriname, Trinidad and Tobago, Uruguay and the Bolivarian Republic of Venezuela.<sup>5</sup> To obtain a greater number of observations for a proper statistical analysis, 29 OECD countries were included in the sample (all of the member countries except Mexico, which is already included in the original sample).

The estimated model takes the following form (the subscript indicates the observation, i.e., the country):

$$PENET_i = f(GDPCAP_i, DENS HH_i, POPURB_i, AGE_i, EDUC_i) + \varepsilon_i$$

$$PENET_i = \alpha_0 + \alpha_1 GDPCAP_i + \alpha_2 DENS HH_i + \alpha_3 POPURB_i + \alpha_4 AGE_i + \alpha_5 EDUC_i + \varepsilon_i$$

Based on the results of the literature that was reviewed, the expected results were:

- The higher the income level, the greater the penetration of broadband -  $\alpha_1 > 0$
- The greater the density, the greater the penetration of broadband -  $\alpha_2 > 0$
- The larger the percentage of urban population, the greater the penetration of broadband -  $\alpha_3 > 0$
- The larger the percentage of people between 15 and 64 years of age, the greater the penetration of broadband -  $\alpha_4 > 0$
- The higher the level of education, the greater the penetration of broadband -  $\alpha_5 > 0$

Table V.1 shows the results of the analysis.<sup>6</sup> The proposed model explains about 86% of the variability in broadband penetration. This confirms the

<sup>4</sup> See Röller and Waverman (2001), Datta and Agarwal (2004), Koutroumpis (2009) and Katz (2009).

<sup>5</sup> Honduras was excluded because comparable data regarding broadband penetration were lacking.

<sup>6</sup> Estimates were made using Stata/SE 11.1 for Windows, calculating robust standard errors.

importance of the economic and demographic characteristics that influence the development of broadband and suggests that only a small proportion (14%) of the differences in penetration between countries can be attributed to other factors. The signs of the coefficients of the determinants are in line with expectations and are significant at 5%, except for the age proxy.

Table V.1  
Determinants of broadband penetration (OLS model)

Variable	Coefficient	Statistic	p >  t
GDPCAP	0.00047	3.65	0.001
DENSHH	0.04992	3.74	0.001
POPURB	0.09119	2.57	0.014
AGE	-0.16804	-0.90	0.371
EDUC	54.07643	2.41	0.020
Constant	-41.50239	-2.39	0.021
Observations		51	
F(5, 45)		53.77	
Prob > F		0.0000	
R <sup>2</sup>		0.8649	

Source: Prepared by the authors.

The disparity in the magnitudes of the coefficients, particularly in the case of education (EDUC), is especially striking, but it should be noted that the units of measurement are different for each variable. In order to estimate the marginal effect of different determinants and proceed to a comparison of the impact of each one separately, we can examine the effect of a 1% increase in each factor on penetration levels (the effects are observed in the averages for the different variables). Table V.2 summarizes these effects:

Table V.2  
Marginal effect on broadband penetration

Variable	Marginal effect
GDPCAP	+0.66%
DENSHH	+0.12%
POPURB	+0.39%
AGE	-0.65%
EDUC	+2.92%

Source: Prepared by the authors.

Using these results, we can proceed to calculate the BPI. The model's predicted penetration rate (PENETP) for each country results from the following equation:

$$PENETP_i = a_0 + a_1 GDPCAP_i + a_2 DENSHH_i + a_3 POPURB_i + a_4 AGE_i + a_5 EDUC_i$$

In which  $a$  represents the estimated coefficients presented in table V.1. The difference between the observed and predicted penetration rates is  $PENET_i - PENETP_i = e_i$ , where  $e_i$  is the estimator of  $\varepsilon_i$ . To facilitate the interpretation of the results, the BPI is defined as:

$$BPI = e_i / \max\{|e_i|\}.$$

Using this procedure, BPI values between -1 and +1 are obtained, with positive values indicating a performance that exceeded expectations, while negative values indicate a performance below expectations. A value close to zero signifies that the country is meeting performance expectations based on its economic endowments and demographic characteristics. Figure V.1 presents a ranking of countries in Latin America and the Caribbean according to the BPI.<sup>7</sup> For purposes of comparison with traditional indicators, the ranking of countries in terms of penetration per 100 inhabitants is given in parentheses.

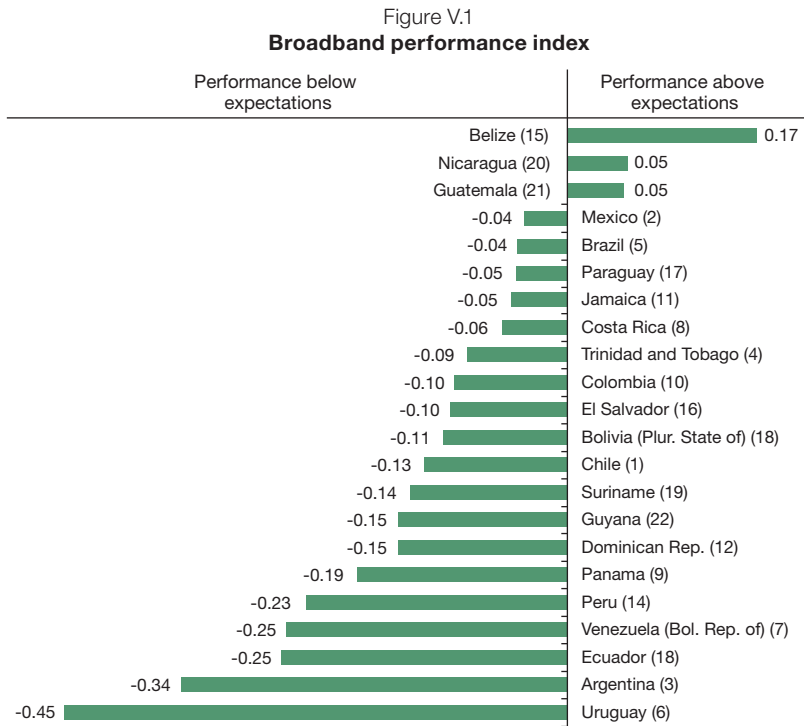

Source: Prepared by the authors based on ITU (2010).

<sup>7</sup> For some countries (Belize, Guatemala and Nicaragua), the model predicts negative penetration rates. In these cases, the predicted value was forced to zero in order to calculate the BPI.

The BPI results indicate that, in general, the countries of the region are performing below their potential for broadband development, given their economic endowments and demographic characteristics. Some countries, such as Mexico and Brazil, do meet expectations with respect to broadband penetration, whereas high-penetration countries such as Argentina and Uruguay are well below the expected levels of service adoption, given their relatively high levels of income and education and favourable demographics (i.e., high urbanization rates). Moreover, the BPI results suggest that certain countries with low penetration rates, such as Paraguay, Nicaragua and Guatemala, fall within their expected levels of penetration or even exceed them. For its part, Chile, a country that leads traditional rankings of penetration in the region, is also below its expected level of broadband development, although the gap is smaller than in the cases of Argentina and Uruguay.

### **C. Price and quality indicators**

The second dimension of interest in the analysis of broadband in Latin America and the Caribbean relates to the observed price levels and quality of service offered by the leading service providers. To account for this dimension—the main focus of this chapter—a survey of all the plans and rates offered by the major operators in each country in the region was undertaken. This survey was carried out using the methodology proposed by OECD, which, among other advantages, allows the results for Latin America and the Caribbean to be compared with those available for developed countries.<sup>8</sup> With this methodology, all plans whose advertised download speed is greater than 256 kbps are considered to be broadband. In each country, the universe of operators covered by the study included, at a minimum, the leading provider of access via xDSL and the largest provider of services via cable modem (if available). A total of 323 plans offered by 54 operators in 23 countries were surveyed. The data correspond to the capital or main city in each country and were compiled during the second half of May 2010. Details regarding criteria, methodology for data collection and conversion of prices into United States dollars at purchasing power parity (PPP) are provided in annexes V.1 and V.2.

---

<sup>8</sup> See <http://www.oecd.org/sti/ict/broadband>.

## 1. *Quality (speed)*

The quality of Internet access services depends on a variety of factors, which include speed and connection stability (measured in terms of fluctuations in latency and packet loss). This is a key variable that affects not only the types of possible uses, but also the service applications that can be offered by basic access services. The development and adoption of advanced e-commerce applications, entertainment, online games and distance education, among many other broadband applications, hinges upon the deployment of high-quality broadband services that can support the demanding quality requirements of those applications.

Typically, Internet access services vary in terms of the download speeds advertised by the service operator, though in some cases the offering includes promises about a particular upload speed and connection stability (QoS). In this chapter, the download speed advertised by the operator is considered to be a proxy for quality of service.<sup>9</sup> As mentioned above, we follow the ITU definition of broadband as any Internet access service with a minimum of 256 kbps download speed. However, the distinction between services proposed by OECD—low speed (256 kbps–2 Mbps), average speed (2.5 Mbps–10 Mbps), high speed (10 Mbps–32 Mbps) and very high speed (>35 Mbps)—is added to this definition.

In terms of the maximum speeds offered, Chile is the best performer among the countries in the sample, followed by Argentina, Brazil and Colombia (see figure V.2). Jamaica, Trinidad and Tobago, Mexico and the Dominican Republic are the only other countries that offer speeds of at least 10 Mbps, which is the lower end of what OECD considers to be high-speed access. At the other extreme, countries in the fifth quintile (Guatemala, Honduras, Belize, Suriname, Guyana) offer maximum speeds of less than 2 Mbps—the low-speed access definition of OECD. At the time that the survey was conducted, none of the countries had residential plans offering speeds higher than 35 Mbps (or “very-high” speed), which reflects the limited deployment of high-capacity networks in the local segment in the region (especially FTTH). It is worth noting that the average maximum speed offered in OECD countries is 9.3 times higher than what is offered in Latin America and the Caribbean.

<sup>9</sup> The speed advertised by operators is no more than a promise of best efforts; the actual speed at any given time depends on a variety of factors. However, in this chapter it is assumed that the relationship between advertised speed and actual speed remains constant for fixed broadband service operators and therefore does not affect comparisons between the respective offerings.

Figure V.2  
**Maximum download speed offered**  
(en Mbps)

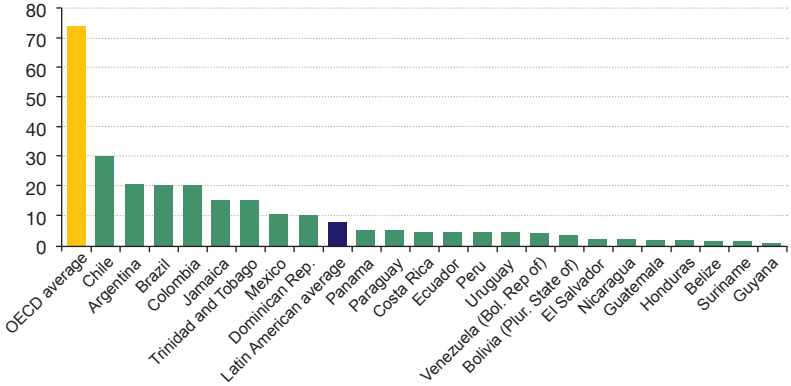

Source: Prepared by the authors.

The relative ranking of countries remains virtually unaltered when the analysis focuses on the average speed offered by all plans in each country (the correlation between the two rankings is 0.97). Chile remains the best performer in terms of the quality of its broadband offering, but is still well below the average speed offered in OECD countries (which is seven times higher than the regional average). Both indicators place the same countries in the same quintile of performance, with the exception of the Plurinational State of Bolivia and Honduras, which switch places within the two lowest-performing groups (see figure V.3).

Figure V.3  
**Average download speed offered**  
(en Mbps)

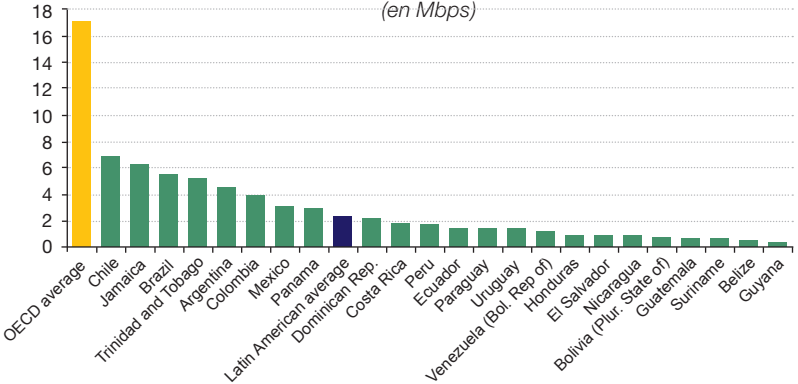

Source: Prepared by the authors.



Finally, table V.3 presents the rankings generated by two measurements of speed. A ranking based on the simple average of these indicators is also included. The results confirm that Chile, Brazil and Argentina are the countries that offer the highest-quality broadband service, while Guyana, Suriname, Belize and Guatemala are among those lagging the furthest behind.

Table V.3  
Ranking of advertised speeds

Country	Maximum speed offered (Mbps)	Average speed offered (Mbps)	Average ranking
Chile	1	1	1.0
Brazil	3	3	3.0
Argentina	2	5	3.5
Jamaica	5	2	3.5
Colombia	4	6	5.0
Trinidad and Tobago	6	4	5.0
Mexico	7	7	7.0
Panama	9	8	8.5
Dominican Republic	8	9	8.5
Costa Rica	11	10	10.5
Paraguay	10	13	11.5
Ecuador	12	12	12.0
Peru	13	11	12.0
Uruguay	14	14	14.0
Venezuela (Bolivarian Republic of)	15	15	15.0
El Salvador	17	17	17.0
Bolivia (Plurinational State of)	16	19	17.5
Honduras	20	16	18.0
Nicaragua	18	18	18.0
Guatemala	19	20	19.5
Belize	21	22	21.5
Suriname	22	21	21.5
Guyana	23	23	23.0

Source: Prepared by the authors.

## 2. Tariffs

The multiplicity of plans, special discount deals and packages offered by broadband operators makes any attempt to compare prices in different countries a formidable undertaking. In this section we present various indicators that, when combined, provide an approximation of the price level of broadband access in the countries of the region and in relation to developed countries (OECD).<sup>10</sup> Following a standard methodology, tariffs are converted into United States dollars at PPP in order to obtain comparable measurements for the different countries (see annex V.2).

<sup>10</sup> OECD data correspond to the fourth quarter of 2009.

The first step in the analysis was to sort countries according to the average advertised price of a broadband connection based on all the plans surveyed (see figures V.4 and V.5). List prices were computed separately from discounted prices (discounted prices are generally offered during the first months of service), but the resulting rankings were basically the same. Given the similarity between the two rankings, list prices were then used in the remainder of the analysis.

Figure V.4  
**Broadband tariffs: average plan (discount price)**  
*(US dollars at PPP)*

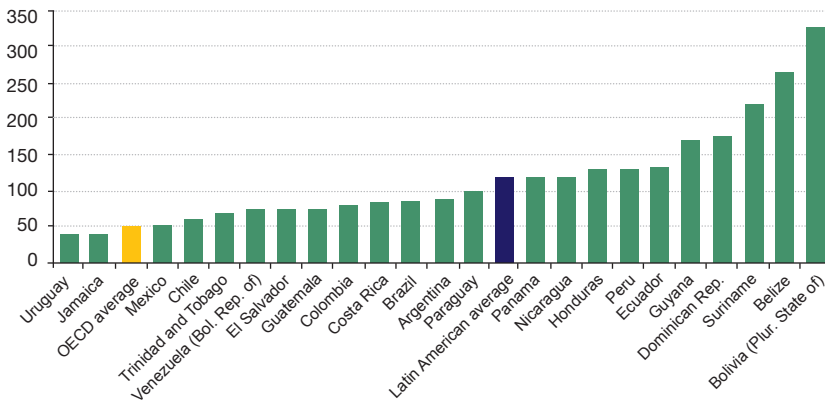

Source: Prepared by the authors.

Figure V.5  
**Broadband tariffs: average list price**  
*(US dollars at PPP)*

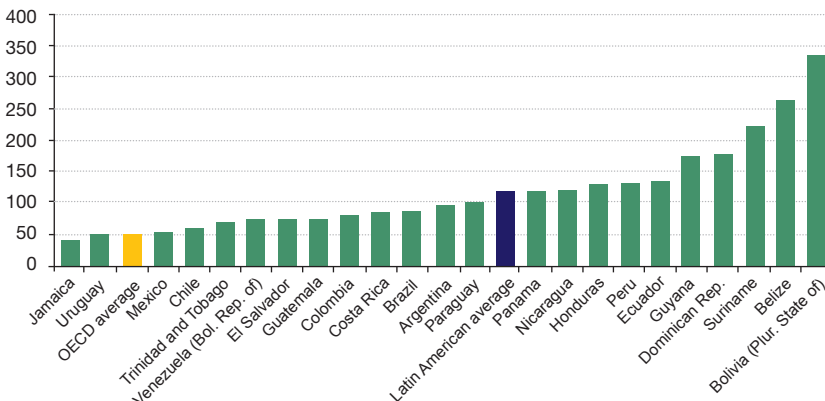

Source: Prepared by the authors.

The first interesting result is that countries with good performances in terms of penetration and quality of service do not necessarily stand out in terms of average prices (this is particularly the case in Argentina and Brazil). However, in general, the results confirm that prices exert an inhibitory effect on service adoption, as four of the five countries in the bottom quintile of service penetration have rates well above the regional average. (The notable exception is Guatemala, which has relatively low average rates but limited service adoption.)

Average prices in the 30 OECD countries are provided as a frame of reference. On average, prices in Latin America and the Caribbean are nearly 2.5 times higher than those observed in OECD countries, which explains part of the difference in penetration. However, it is worth noting that the best-performing countries (Uruguay, Jamaica, Mexico and Chile) have average rates comparable to those in OECD countries, and virtually every country in the first and second quintile offers average prices within 1 standard deviation of the OECD average.

Another indicator commonly used is price per megabit per second (Mbps), which allows comparisons to be based upon a standardized measure of price/quality. In other words, this indicator makes it possible to measure the value obtained in each country for every dollar spent on broadband service. As shown in the following figure, Jamaica, Chile and Mexico still lead the region by offering the lowest price per Mbps. On the other hand, Uruguay makes a poorer showing in the price-per-Mbps comparison due to the low average speed offered by its main operator. The Bolivarian Republic of Venezuela, El Salvador and Guatemala are in a similar situation, as they fall from the second to fourth quintile. Countries with high-speed plans, such as Argentina and Brazil, have a higher ranking when this indicator is used, since these plans tend to have a lower cost per Mbps (see figure V.6).

While the performance of countries in the first quintile is comparable to the OECD average ( $\pm$  one standard deviation), the average price per Mbps in the region is 15.5 times higher than it is in developed countries. Again, the key difference is the high- and very-high-speed plans offered in OECD countries; the price/quality ratio is therefore significantly less attractive in Latin America and the Caribbean.

Figure V.6  
**Broadband tariffs per Mbps**  
*(US dollars at PPP/Mbps)*

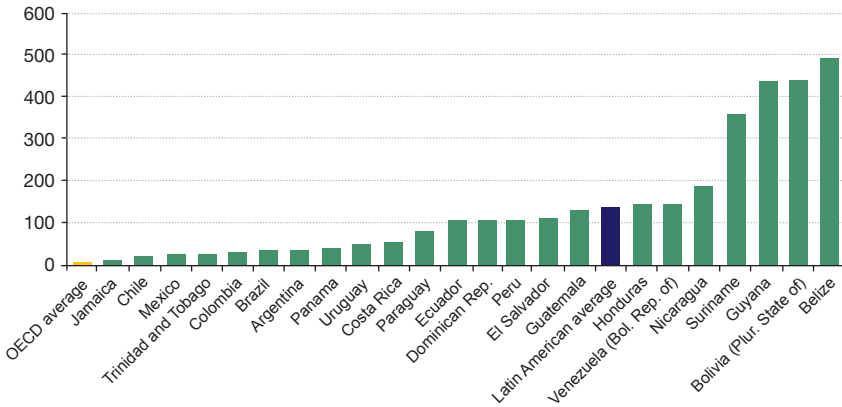

Source: Prepared by the authors.

In order to mitigate the bias of the previous indicator, the comparison of plans is segmented based on service speed (see figures V.7, V.8 and V.9). In the low-speed access segment (256 kbps-2 Mbps), average rates in the region are three times higher than those reported in the OECD countries, a difference that increases to 3.5 times in the medium-speed tier (2.5 Mbps-10 Mbps) and the high-speed tier (10 Mbps-32 Mbps).

Figure V.7  
**Broadband tariffs: average for low-speed plans**  
*(US dollars at PPP)*

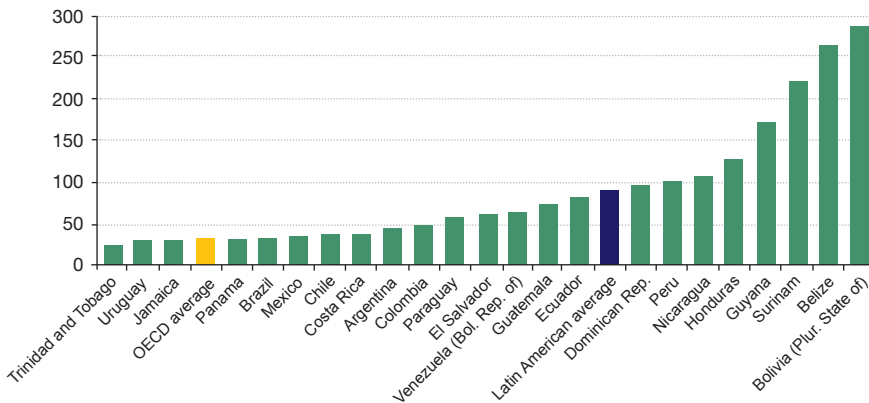

Source: Prepared by the authors.

Figure V.8  
**Broadband tariffs: average for medium-speed plans**  
*(US dollars at PPP)*

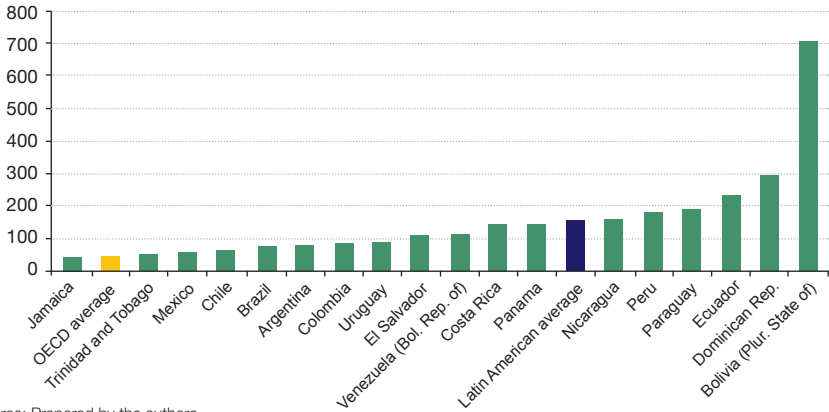

Source: Prepared by the authors.

Figure V.9  
**Broadband tariffs: average for high-speed plans**  
*(US dollars at PPP)*

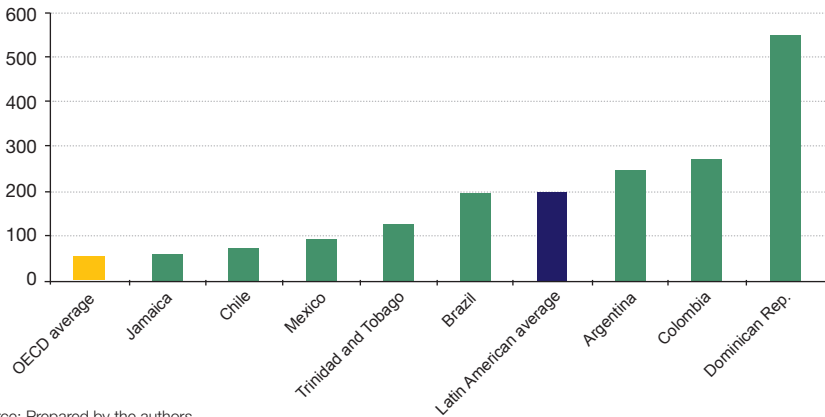

Source: Prepared by the authors.

Finally, the lowest tariffs for broadband Internet access in the countries of the region were also compared (figure V.10). The price of the entry-level plan is an important indicator because it establishes the minimum level of expenditure required in order for a household or microenterprise to access broadband services and is therefore used in several international comparisons. These plans are a central element of the universal broadband initiatives adopted in various countries in an effort to reduce barriers to adoption by fostering the provision of basic connectivity plans.

It comes as no surprise that Uruguay and the Bolivarian Republic of Venezuela are the best-performing countries in the region, since government control over the main telecommunications operator makes it possible to offer basic connectivity plans (typically with low speeds and caps on data volume) at reduced rates. A similar initiative is under way in Brazil, where various private operators have joined the “Broadband for the People” plan being implemented in the State of São Paulo, which offers tax benefits to operators that join the initiative.<sup>11</sup> Chile is in an opposite situation, falling to the third quintile. The Plurinational State of Bolivia, Nicaragua, Guyana, Suriname, Honduras and Belize are the worst performers in this indicator, which is consistent with their poor performance as measured by other indicators used here.

Figure V.10  
**Broadband tariffs: least expensive plan**  
(US dollars at PPP)

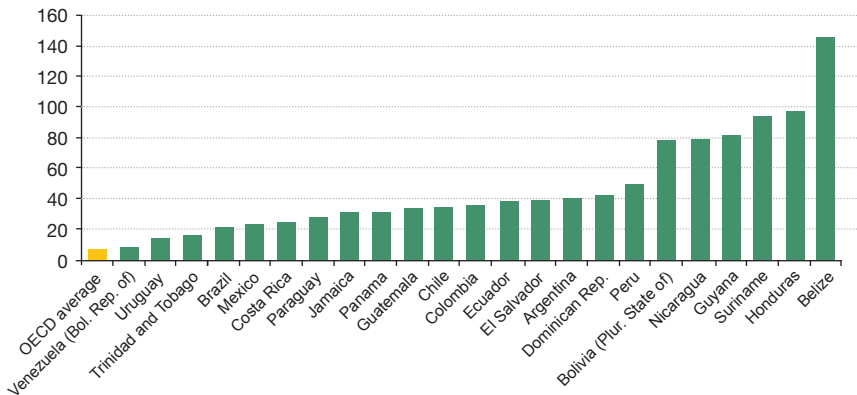

Source: Prepared by the authors.

Table V.4 summarizes the results of the plans and tariffs survey and includes a ranking based on the simple average of the various indicators.

<sup>11</sup> In a number of countries in the region, basic plans targeting lower-income households are available. These plans, which are similar to subsidized basic telecommunications service plans, have various restrictions on download speed and traffic volumes, and, in some cases, include a pre-pay modality. The pre-pay broadband plan offered by CANTV in the Bolivarian Republic of Venezuela for US\$ 7 per month provides ADSL access with a download speed of 256 kbps (the minimum for broadband) and 128 kbps upload, with a limit of 500 Mb per month. In Uruguay, the State-run telecommunications company, ANTEL, offers a basic plan with a download speed of 1024 kbps and a 2 Gb limit for US\$ 9 per month (with special discounts). In Brazil, Telefónica offers a plan under the “Broadband for the People” initiative of the State of São Paulo with a download speed of 256 kbps and a download limit of 10 Gb for approximately US\$ 17 per month.

Table V.4  
**Ranking of tariffs**

Country	US dollars at PPP discount price	US dollars at PPP list price	US dollars at PPP per Mbps	Least expensive plan	Average ranking
Jamaica	2	1	1	8	3.0
Mexico	3	3	3	5	3.5
Uruguay	1	2	9	2	3.5
Trinidad and Tobago	5	5	4	3	4.3
Chile	4	4	2	11	5.3
Venezuela (Bolivarian Republic of)	6	6	18	1	7.8
Brazil	11	11	6	4	8.0
Colombia	9	9	5	12	8.8
Costa Rica	10	10	10	6	9.0
Guatemala	8	8	16	10	10.5
El Salvador	7	7	15	14	10.8
Paraguay	13	13	11	7	11.0
Panama	14	14	8	9	11.3
Argentina	12	12	7	15	11.5
Ecuador	18	18	12	13	15.3
Peru	17	17	14	17	16.3
Nicaragua	15	15	19	19	17.0
Dominican Republic	20	20	13	16	17.3
Honduras	16	16	17	22	17.8
Guyana	19	19	21	20	19.8
Suriname	21	21	20	21	20.8
Bolivia (Plurinational State of)	23	23	22	18	21.5
Belize	22	22	23	23	22.5

Source: Prepared by the authors.

To conclude, the results show:

- I. A high degree of dispersion in the tariffs charged in the region, even in markets with similar characteristics, which points to the existence of opportunities for regulatory action aimed at strengthening competition and addressing potential bottlenecks in the various segments that comprise the Internet access market.
- II. A lower quality of service and a significantly higher average fee than in OECD countries, particularly for medium-speed (2.5 Mbps-10 Mbps) and high-speed (10 Mbps-32 Mbps) plans. In the best-performing countries in the region, however, prices are comparable to those of the OECD countries, which underscores the need to take the actions mentioned in the previous paragraph.
- III. The importance of offering basic connectivity plans as a way of reducing current price levels and thereby extending the boundaries

of the residential market for broadband Internet access. The results suggest that a balance can be struck between price and quality, since some countries stand out in terms of value per Mbps while others do so in terms of low entry-level costs. Uruguay and the Bolivarian Republic of Venezuela are examples that illustrate the potential for demand segmentation as a means of extending connectivity to the base of the income pyramid.

#### **D. Estimating the effect of price on broadband demand**

The results of the BPI discussed in the second section suggest that broadband adoption depends largely on the wealth and demographic characteristics of individual countries. In other words, it depends on long-term variables which policymakers have no more than a limited capacity to influence in the short term. On the other hand, the price of broadband access services is a variable that governments can act upon through various tools for promoting competition and correcting market failures. Consequently, the estimated impact of tariff changes on the adoption of the service is a key consideration in defining broadband policies.

The price variable has deliberately been omitted from the model used for calculating the BPI, since, as pointed out by Hauge and Prieto (2010), the penetration level is determined by the interaction of the availability of services, the plans offered and the demand for the service. Therefore, price and penetration are determined simultaneously, and other econometric tools are therefore required in order to isolate the effect of price on broadband penetration. This section addresses this issue. (Annex V.3 contains more detailed information on the methodology used and the results.)

The correlation between price and penetration indicators suggests that an association between the two variables exists. As an example, figure V.11 shows the simple correlation between the price per Mbps (in PPP dollars) and the penetration rate per 100 households for the 23 countries of Latin America and the Caribbean and the 29 OECD countries in the sample.<sup>12</sup> As expected, the lower the price, the higher the penetration.

---

<sup>12</sup> Honduras has been excluded because comparable data regarding broadband penetration are lacking.



Figure V.11

**Correlation between price (US dollars at PPP / Mbps) and broadband penetration**  
 (Connections per 100 households)

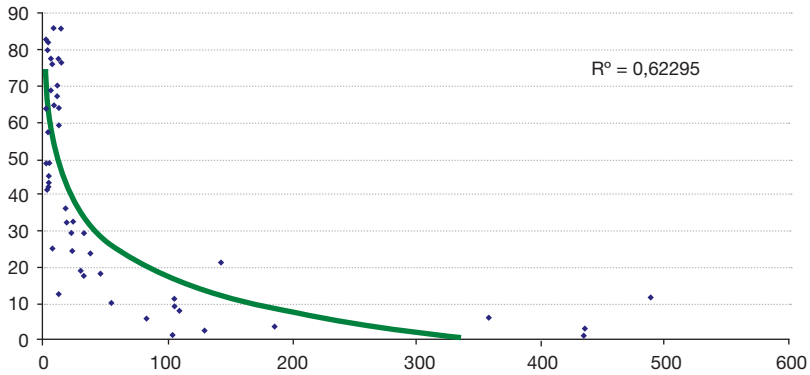

Source: Prepared by the authors on the basis of information from ITU (2010).

In order to isolate the effect of price on broadband demand, we start by estimating a simple regression model that considers four demand factors identified by the literature as determinants of the level of broadband penetration (PENET).<sup>13</sup>

- Price: Monthly subscription cost in United States dollars at PPP (*PRICE*)
- Income: Per capita GDP in United States dollars at PPP (*GDPCAP*)
- Age: Percentage of the population between 15 and 64 years of age (*AGE*)
- Education: United Nations education index (*EDUC*)

In the case of *PRICE*, we use average discount prices in each country (see the third section). For the other variables, the data are similar to the data used to compute the BPI (see the second section). Again, the time lag in the explanatory variables is a consequence of the availability of data, but also makes it possible to mitigate a potential endogeneity problem.

<sup>13</sup> The selection of variables for inclusion in the regression is based on theoretical considerations and data availability, while taking account of the need to limit the number of parameters to be estimated, given the relatively small number of observations.

Price and digital illiteracy appear among the most frequently mentioned barriers to the adoption of broadband (Horrigan, 2009).<sup>14</sup> Digital illiteracy—the inability to use digital technologies to find, use and create information—tends to be the most formidable barrier among older people and those who are less educated (Hauge and Prieto, 2010). *AGE* and *EDUC* are included as proxies for this determinant of broadband adoption.

The countries analysed are Argentina, Belize, the Plurinational State of Bolivia, Brazil, Chile, Colombia, Costa Rica, the Dominican Republic, Ecuador, El Salvador, Guatemala, Guyana, Honduras, Jamaica, Mexico, Nicaragua, Panama, Paraguay, Peru, Suriname, Trinidad and Tobago, Uruguay and the Bolivarian Republic of Venezuela. In order to have a greater number of observations for proper statistical analysis, 29 OECD countries have been included in the sample (all the member countries except Mexico, which was already included in the original sample).

The broadband demand function is estimated as follows (the subscript indicates the observation, i.e., the country):

$$PENET_i = f(PRICE_i, GDPCAP_i, AGE_i, EDUC_i) + u_i$$

$$PENET_i = \beta_0 + \beta_1 PRICE_i + \beta_2 GDPCAP_i + \beta_3 AGE_i + \beta_4 EDUC_i + u_i$$

Based on previous studies, we expect to find that:

- The higher the prices, the lower the demand for broadband -  $\beta_1 < 0$
- The higher the income level, the greater the demand for broadband -  $\beta_2 > 0$
- The larger the percentage of people between 15 and 64 years of age, the greater the demand for broadband -  $\beta_3 > 0$
- The higher the level of education, the greater the demand for broadband -  $\beta_4 > 0$

The following table shows the results for the OLS estimation.

<sup>14</sup> The lack of a computer at home is another major barrier, but the lack of current data prevents this variable from being included in the specification. However, given the high correlation between penetration of personal computers and per capita GDP (Chinn and Fairlie, 2006), the inclusion of *GDPCAP* among the determinants should capture this effect, at least in part.

Table V.5  
**Broadband demand estimation (OLS)**

Dependent variable: PENET		
Variable	(1)	(2)
PRICE	-0.121*** (0.026)	-0.029* (0.015)
GDPGAP		0.0005*** (0.0001)
AGE		-0.286 (0.266)
EDUC		57.026*** (20.363)
Constant	26.257*** (2.504)	-26.338* (15.031)
Observations.	51	51
R <sup>2</sup>	0.35	0.84

Source: Prepared by the authors.

Notes: \*\*\* Significant at 1%.

\*\* Significant at 5%.

\* Significant at 10%.

Standard errors indicated in brackets.

Column (1) presents a simple regression in which price is the only variable. The coefficient has the expected sign and is significantly different from zero at 1%. Column (2) includes the control variables, i.e., per capita GDP, age and education. The price effect decreases sharply and is significant only at 10%. The model explains about 84% of the variance in service penetration. The signs of the coefficients are as expected and are significant at usual confidence levels, except for the *AGE* proxy, which is not significant. In this specification, while it is possible to detect a price effect on broadband demand, that effect is small. For example, a 10% reduction in the average price (from US\$ 77 PPP to US\$ 70 PPP) results in only a 1.32% increase in penetration (estimated in the means of the variables).

As mentioned above, the problem is that price is potentially endogenous in the demand function. If broadband demand and supply vary over time, penetration and observed prices reflect a set of equilibrium points (i.e., the intersection of supply and demand). In that case, an OLS estimate of penetration against price will not identify the demand or supply function (Angrist and Krueger, 2001). To correctly capture the effect of price on broadband demand, it is necessary to identify a factor that affects supply without affecting demand for broadband, i.e., an instrumental variable (IV). The idea is to isolate the exogenous variability (i.e., not caused by demand factors) in order to estimate the impact of price on broadband demand.

Household density per square kilometre (*DENSHH*) was selected as an instrumental variable, since, as shown extensively in the literature, density affects the cost of deploying telecommunications infrastructure (Cribbett, 2000). In an

industry with large economies of scale, it is expected that a higher population density implies lower unit costs and therefore lower prices, on average. On the other hand, there is no reason to hypothesize that density affects the demand for broadband services (except through the effect on the price).<sup>15</sup>

Table V.6 presents the results of the estimation of broadband demand, which includes the *PRICE* variable instrumented by *DENSHH* (see annex V.3).

Table V.6  
Broadband demand estimation (IV model)

Dependent variable: PENET		
Variable	(1)	(2)
PRICE	-0.248*** (0.068)	-0.190* (0.104)
GDP CAP		0.0003** (0.0001)
AGE		-0.944 (0.727)
EDUC		26.702 (47.379)
Constant	36.131*** (4.834)	60.844 (65.149)
Observations	51	51
R <sup>2</sup> (centred)	-0.04	0.44
R <sup>2</sup> (uncentred)	0.63	0.80

Source: Prepared by the authors.

Notes: \*\*\* Significant at 1%.

\*\* Significant at 5%.

\* Significant at 10%.

Robust standard errors were estimated and indicated in brackets.

With the aid of the instrument, the observed effect of price on broadband demand proves to be greater than the one suggested by the OLS estimation (column (2)). To quantify this effect, the elasticity for each country is calculated, given that, as an estimate of linear demand, elasticity is different at every point and, of course, is greatest where the price is high and penetration is low. The penetration rate is then calculated using the estimated elasticity and different assumptions about the price reduction in each country, ranging from 10% to 50%. Table V.7 shows the results of this exercise.<sup>16</sup>

<sup>15</sup> This is the identification assumption maintained throughout the analysis. See annex V.3 for a discussion of its validity.

<sup>16</sup> Elasticity is defined for small variations in price. The calculations in the table should be taken more as a hypothetical exercise than as an accurate prediction of the response in penetration to price changes. Only under the assumption of constant elasticity would the calculations be accurate; in the opposite case, the greater the variation in price, the less accurate the approximation will be.

Table V.7  
**Estimate of the impact of price on broadband penetration**

Country	Penetration rate in 2009	Hypothetical reduction in average prices				
		-10%	-20%	-30%	-40%	-50%
Predicted penetration rates						
Argentina	8.80	9.82	10.84	11.86	12.88	13.91
Belize	2.61	3.17	3.73	4.29	4.86	5.42
Bolivia (Plurinational State of)	2.86	3.43	3.99	4.56	5.12	5.69
Brazil	7.51	8.88	10.26	11.63	13.01	14.38
Chile	9.81	10.55	11.29	12.03	12.78	13.52
Colombia	4.64	5.28	5.93	6.57	7.21	7.85
Costa Rica	6.01	7.11	8.21	9.31	10.41	11.52
Dominican Republic	3.93	6.01	8.09	10.17	12.26	14.34
Ecuador	1.77	3.38	4.98	6.59	8.20	9.80
El Salvador	2.42	2.66	2.90	3.14	3.38	3.62
Guatemala	0.78	0.84	0.91	0.97	1.04	1.10
Guyana	0.26	0.40	0.54	0.68	0.82	0.96
Jamaica	4.13	4.30	4.47	4.64	4.80	4.97
Mexico	9.05	9.53	10.01	10.49	10.97	11.45
Nicaragua	0.82	1.38	1.95	2.51	3.07	3.64
Panama	5.82	8.09	10.35	12.62	14.88	17.15
Paraguay	2.22	2.68	3.14	3.60	4.06	4.52
Peru	2.79	5.22	7.65	10.08	12.51	14.94
Suriname	1.65	2.06	2.48	2.89	3.31	3.72
Trinidad and Tobago	7.84	8.75	9.66	10.57	11.47	12.38
Uruguay	7.30	7.53	7.76	7.99	8.22	8.45
Venezuela (Bol. Rep. of)	6.51	7.15	7.78	8.42	9.06	9.69
Average for Latin America	4.52	5.37	6.22	7.07	7.92	8.77

Source: Prepared by the authors.

As shown here, the effect of a price reduction is greater in countries with low penetration and high rates, such as the Plurinational State of Bolivia, Ecuador and the Dominican Republic, than in countries with high penetration and lower rates, such as Chile and Uruguay. In the last stage of the exercise, the average elasticity for the total sample as well as for each group of countries is calculated (see table V.8).

Table V.8  
**Price elasticity for broadband demand**

	Price elasticity
Total sample	0.68
Latin American average	1.88
OECD average	0.53

Source: Prepared by the authors.

The results confirm the observation that the price elasticity of broadband demand in the countries in the region is higher than it is in the OECD countries.<sup>17</sup> In the case of Latin America and the Caribbean, an average price reduction of 10% would result in an increase of almost 19% in the penetration rate, which is equivalent to 4.7 million additional broadband connections. However, it should also be noted that, even with price reductions of 50%, the region would still be far from the penetration levels observed in the OECD countries. This finding validates the search for complementary strategies such as fostering mobile broadband connectivity, shared access models and broadband subsidies for schools (see box V.1).<sup>18</sup>

#### Box V.1

##### **Brazil's national broadband plan**

In May 2010, the Brazilian government announced an ambitious National Broadband Plan (known by its Portuguese-language acronym, PNBL), one of whose main objectives is to triple the number of residential connections. The plan calls for a reduction of approximately 40% in the price of the least expensive broadband subscription in the short term (from the current level of R\$ 49 to R\$ 29, before taxes). The findings of this section make it possible to assess whether this price reduction would be sufficient to meet the objectives proposed in the PNBL. The results presented in table V.7 indicate that a price cut of 40% would almost double the rate of penetration in Brazil to about 13%. However, in order to triple the penetration rate (raising penetration levels from 7.5% to 22.5%) price reductions of over 85% would be required, which is not feasible in the short term. This suggests the need to act on other variables affecting demand in order to achieve the plan's goals.

## **E. Broadband affordability**

As a means of complementing the results outlined in section 3 regarding price levels for broadband Internet access in the region, this section will

<sup>17</sup> The estimates of elasticity are in line with the findings of other studies. For example, Ford et al. (2007) reported a 0.371 elasticity for OECD member countries. Other surveys have yielded higher estimates. Cardona et al. (2009) have calculated broadband demand elasticity in Austria at between 0.97 and 2.61, depending on the available technologies (DSL, cable modem, 3G). For the United States, Goolsbee (2000) estimated demand elasticity for broadband service via cable modem at between 2.8 and 3.5; the estimate put forth by Rappoport et al. (2002) is 0.587 for cable modem and 1.462 for DSL; and Varian (2002) has calculated that broadband demand elasticity is between 1.3 and 3.1.

<sup>18</sup> A critical review of the international experience in regard to stimulus programmes for broadband demand can be found in Hauge and Prieger (2010).

analyse the affordability of these services by comparing the tariffs charged with household income levels in order to estimate the relative effort that families have to make (or would have to make in the case of households not yet connected) to pay for broadband services. Affordability refers to the ability to pay for a service in different income strata and, as such, is a fundamental dimension of broadband demand estimations. Moreover, the design of effective policies to expand broadband services depends on a correct estimation of affordability for target households. Interestingly, this issue has hardly been addressed in the research literature, and the few available studies have yielded inconsistent results (Clarke et al. 2009; Rosston, Savage and Waldman, 2010; Hauge and Priege, 2010).

We start from the assumption that households are willing, on average, to spend a certain percentage ( $T\%$ ) of their income for broadband Internet service. If the actual cost of the service exceeds  $T$ , the probability of adoption is low, while if service costs less than  $T$ , the probability is high. Therefore,  $T$  is considered to be the threshold of broadband affordability.

The evidence regarding the value that  $T$  assumes in different countries and at different income levels is limited. Following Barrantes and Galperin (2008), a preliminary estimate of  $T = 5\%$  is set. This value is widely used both in academic research and in policy studies conducted by specialized international agencies as a general threshold for telecommunications expenditures (Milne, 2006), and its validity is confirmed by the latest evidence available for Latin America and the Caribbean (Marchionni and Gluzman, 2010).<sup>19</sup> Since this threshold is typically used for expenditure on all telecommunications services, it represents a conservative threshold when applied only to broadband services (and therefore the results to follow may overestimate the true affordability of the service).

Typically, the ratio between the price charged for a service and average GDP per capita or per household is used as a proxy for affordability. For example, figure V.12 shows the average list price of broadband Internet services as a proportion of GDP per household (on a monthly basis) for the sample of Latin American and Caribbean and OECD countries analysed in this chapter.

---

<sup>19</sup> The authors examined the total telecommunications expenditure of average households in eight countries in the region and found that they came close to reaching 5% only in Colombia and that spending levels were significantly lower in cases such as Mexico (3.1%) and Peru (1.4 %).

Figure V.12  
**Broadband affordability: average list price as a percentage of GDP per household**  
*(US dollars at PPP)*

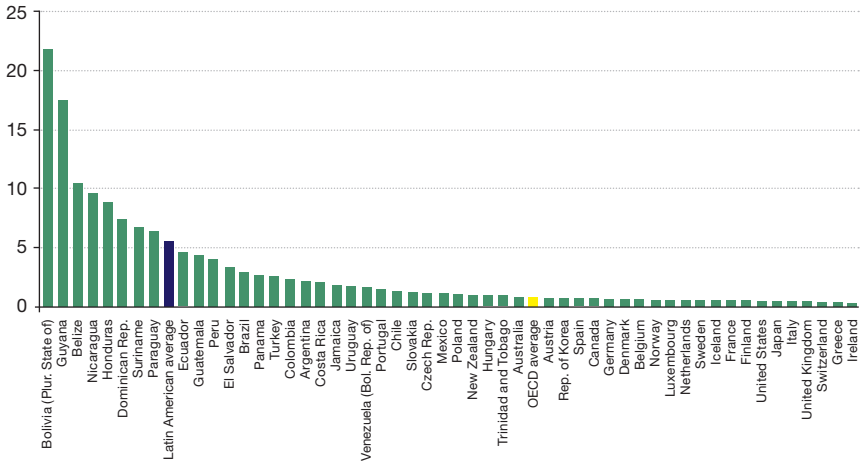

Source: Prepared by the authors.

This indicator suggests that, in over half of the countries of the region (15 out of 23), the cost of Internet access (average list price) is below the threshold of 5% of household income. While the regional average is slightly above this threshold, it is clearly biased by some countries with very low affordability rates, such as the Plurinational State of Bolivia and Guyana. It is worth noting, however, that the average for the region is nearly eight times as high as the average for the OECD countries, which provides an indication of just how much more of an effort households in Latin America and the Caribbean must make in order to purchase broadband services. The affordability of broadband is similar to that of developed countries in only a few countries in the region, among them Trinidad and Tobago and Mexico.

The situation improves significantly when we look at the least expensive plan offered in each country. As shown in figure V.13, the number of countries above the 5% threshold drops from eight to five. On average, however, broadband remains more affordable for households in the OECD countries, where the cost of the cheapest plan represents only 0.3% of average monthly income, while in Latin America it represents 2.5%. In other words, the effort required of a household in the region to purchase broadband services is eight times higher than the effort required, on average, of an OECD household.



Figure V.13  
**The least expensive list price as a percentage of GDP per household**  
*(US dollars at PPP)*

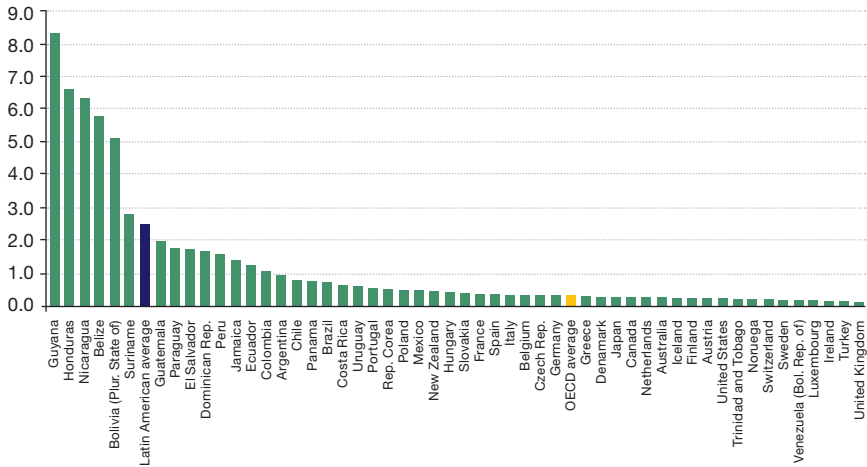

Source: Prepared by the authors.

The results obtained from affordability indicators at the aggregate level, however, conceal many measurement problems. First, dividing a country's total GDP by the total number of households results in a proxy with limited validity for estimating the true household demand for broadband. (This is confirmed by data obtained from household surveys which suggest that disposable household incomes are significantly lower, as discussed below.) But it is even more problematic to work with average indicators in countries that have pronounced income distribution inequalities, as is the case for countries in Latin America and the Caribbean. This kind of situation calls for the use of indicators that are disaggregated by income levels and obtained from household surveys rather than national accounts.

What follows is a preliminary analysis of broadband affordability by income level based on three countries (Argentina, Brazil and Colombia) for which recent data for household income in urban and rural areas are available.<sup>20</sup> Figures V.14 through V.18 illustrate the threshold of 5% of household expenditure on telecommunications for each income decile (in national currency), as well as the price of the least expensive broadband plan available on the market (represented by the dotted line). This allows us to

<sup>20</sup> The authors wish to thank their colleagues at the Centro de Estudios Distributivos, Laborales y Sociales de la Universidad Nacional de La Plata (CEDLAS), particularly Guillermo Cruces, for their assistance in processing the relevant microdata.

estimate the affordability gap, which corresponds to the difference between the household income available for expenditure on telecommunications (i.e., the 5% threshold) and the corresponding rate (in this case, the least expensive plan available).

In the case of Argentina, the results confirm the conclusions drawn from the analysis at the aggregate level: generally speaking, the affordability gap is small. As can be seen here, only 20% of households (the poorest quintile) are not able to afford the cost of broadband service, which suggests that a large potential exists for market growth. Furthermore, the findings are consistent with Argentina's BPI analysis, which indicates that broadband penetration is well below expectations for the country.

Figure V.14  
**Argentina (total country): affordability of broadband service, by income decile, Q3 2009**  
 (Local currency)

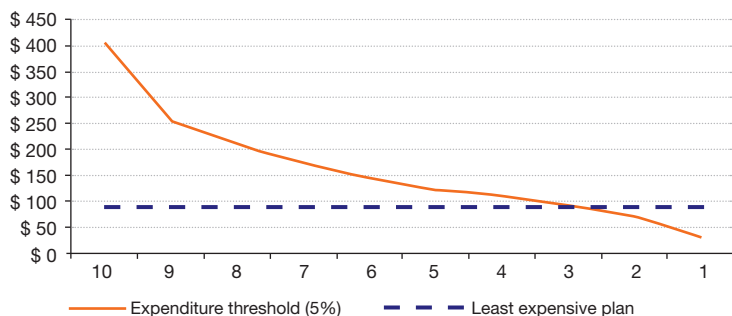

Source: CEDLAS and the authors.

The data for Brazil also make it possible to identify households in rural areas, which is important given the limited availability of Internet service in those areas. Figure V.15 presents the affordability gap for all households in the country. The figure includes both the current minimum rate (R\$ 49) and the PNBL target rate (R\$ 29) (see box V.1). As shown in the figure, this price reduction would extend the boundaries of the broadband market from 60% to 80% of households in the country, while another type of connectivity solution must be sought for the remaining 20% (the poorest quintile).

Figure V.15  
**Brazil (total country): affordability of broadband, by income decile, Q3 2009**  
 (Local currency)

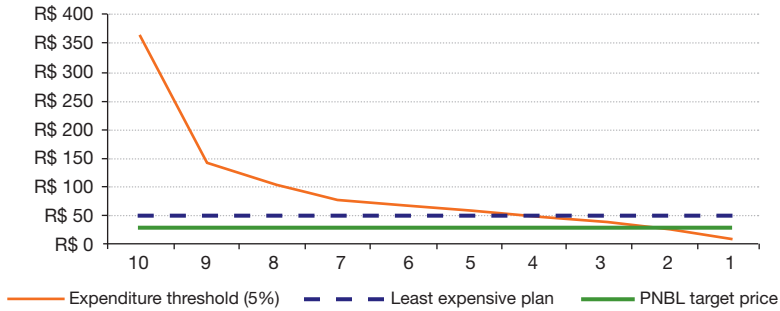

Source: CEDLAS and the authors.

However, if we look only at households in rural areas (for which income levels are significantly lower), we can see that, as shown in figure V.16, the effect of the PNBL target price reduction would be larger, as it would expand the boundaries of the market from 40% to 70% of households. Again, other tools will be needed to provide connectivity to the poorest 30% of households in rural areas.

Figure V.16  
**Brazil (rural areas): affordability of broadband, by income decile, Q3 2009**  
 (Local currency)

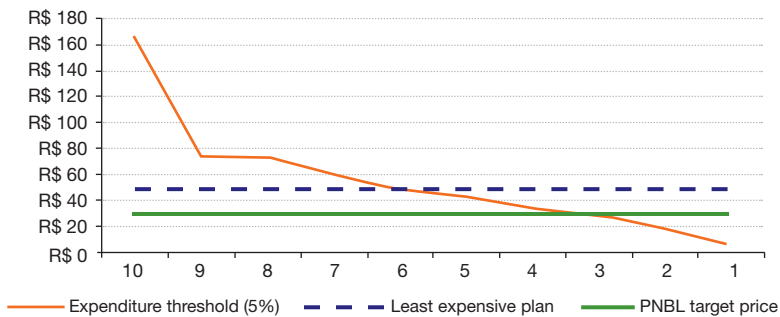

Source: CEDLAS and the authors.

In the case of Colombia, as shown in figure V.17, the affordability analysis for the entire country suggests that the potential market amounts to only one half of all households, since, for the rest, the lowest tariff available exceeds the threshold of available expenditure on telecommunications.

Figure V.17  
**Colombia (total country): affordability of broadband, by income decile, Q4 2009**  
(Local currency)

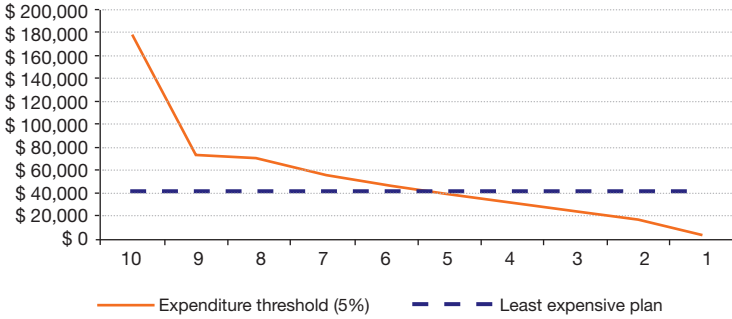

Source: CEDLAS and the authors.

In the case of households in rural Colombia, the gap is significantly larger, as shown in figure V.18. In this case, only 20% of households have the disposable income needed to purchase the service at current prices. The analysis makes it possible to estimate that a 40% price reduction, which means reducing the current lowest tariff from 42,000 pesos to approximately 25,000 pesos —a discount similar to that proposed by the Brazilian PNBL— would result in a significant expansion of the market, allowing at least half of rural households to purchase the service.

Figure V.18  
**Colombia (rural areas): affordability of broadband, by income decile, Q4 2009**  
(Local currency)

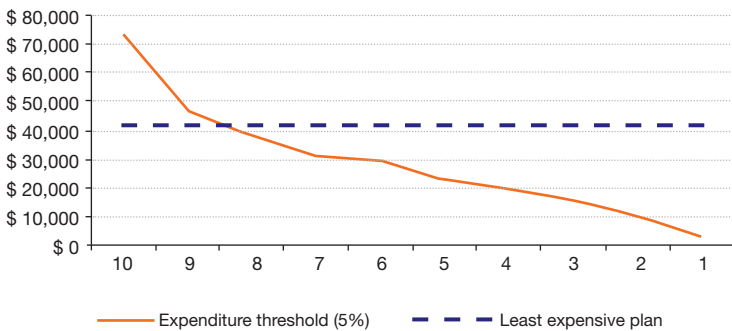

Source: CEDLAS and the authors.

In summary, the affordability analysis shows that there is still a long way to go in Latin America and the Caribbean before broadband reaches the majority of households. On the one hand, the aggregate analysis indicates that, on average, households in the region must make an effort eight times greater than the effort made by households in developed countries to buy broadband services, owing both to their lower income levels and to the higher tariffs charged in the region. It is worth reiterating, however, that the average figure is heavily biased by a few countries with very low affordability levels and that, in some countries in the region, affordability levels are comparable to those in OECD countries.

A better approximation of households' true ability to pay for the service can be obtained from a disaggregated affordability analysis; the results of this analysis confirm both the potential for market growth in high-income countries such as Argentina and Brazil and the existence of challenges to connectivity in low-income rural areas where the cost of network deployment is high. As shown in the case of Colombia, price reductions are necessary but not sufficient to achieve universal connectivity in these areas and must be supplemented with other connectivity initiatives.

## **F. Conclusions**

The relationship between the price level of a service and disposable household income is a key consideration for an accurate delimitation of market boundaries as well as for the design of public policies aimed at expanding those boundaries. This chapter discusses the price level of fixed broadband Internet services in the residential segment in Latin America and the Caribbean and seeks to estimate the affordability of those services for different households along the income distribution curve in each country. The chapter also proposes new diagnostic tools for broadband development and improved approaches for estimating the potential effect of rate changes on the level of service adoption.

The analysis leads to two general conclusions. The first is that there is ample room for reducing tariffs and improving the quality of fixed broadband services in Latin America and the Caribbean. The second is that broadband adoption can, to a large extent, be accounted for by economic endowments and the demographics of a country and that initiatives aimed at bringing about price reductions should be supplemented by public policies focusing on other demand variables (e.g., digital literacy programmes) and alternative

access strategies (e.g., mobile broadband or shared access). In other words, good regulatory practices are necessary but not sufficient. Due to the above-mentioned factors, countries in the region require proactive initiatives to extend networks and to stimulate broadband demand in order to approach the penetration levels found in OECD countries.

The Broadband Performance Index (BPI) shows that countries in the region are not meeting their potential for broadband development. In other words, given their economic endowments and demographic characteristics, there is significant market growth potential, particularly for middle- and high-income countries with educated populations. Moreover, the results draw attention to just how much influence structural determinants (income and education levels, demographics and geographical characteristics) have on the deployment and adoption of broadband, which explains much of the gap between Latin America and the Caribbean and developed countries.

The results of the tariff survey indicate that there is significant dispersion in the prices and quality of services offered in the region. The price differences existing between markets with similar characteristics, in particular, point to the existence of opportunities for regulatory action aimed at strengthening competition and at addressing possible anti-competitive practices in the various segments that comprise the Internet access market.

Benchmarking with OECD countries does not cast the region in a favourable light as, in general, service quality is lower and prices higher. Average prices in the region are almost three times higher than those reported in OECD countries, though, as mentioned earlier, there is significant price dispersion within the region, and those countries with the strongest performance have tariffs comparable to tariffs in OECD countries. The differences are exacerbated when utilizing indicators normalized to cost per Mbps, as the higher-speed plans available in the OECD countries result in lower prices per unit of service. This finding underscores the need to promote service segmentation so that the market can meet the demand for high-quality services while at the same time offering basic connectivity plans at affordable prices. Initiatives establishing “social rates” for broadband services in Uruguay, the Bolivarian Republic of Venezuela and Brazil are noteworthy in this regard. In general, countries with very strong relative performances in terms of penetration do not necessarily stand out in terms of quality or price, which underscores the value of taking a multidimensional approach to international comparisons.

Estimating the effect of price on broadband demand confirms the findings regarding the growth potential of broadband in Latin America and

the Caribbean. On the one hand, the results validate the association between price and service penetration. Furthermore, econometric modeling suggests that broadband demand is elastic to price in the region, while it appears to be relatively inelastic in the more developed markets of the OECD countries. More specifically, the results suggest that an average price reduction of 10% would lead to an increase of almost 19% in the penetration rate in the region (equivalent to 4.7 million additional connections). This important finding highlights the need for further competition in the access market as a means of universalizing services. On the other hand, the analysis also indicates that, even if prices were to be reduced drastically, the region would still fall far short of the penetration levels of the OECD countries; this corroborates the need for complementary connectivity strategies.

Finally, the affordability analysis shows that, on average, households in Latin America and the Caribbean must make an effort eight times greater than households in developed countries in order to acquire broadband services owing to the region's lower income levels and higher fees. In turn, the affordability gap indicator suggests that the ability to pay for the service varies significantly for different households, depending on their income levels and geographic location. As the example of the PNBL initiative in Brazil illustrates, this analytical tool allows us to estimate the potential impact of government initiatives aimed at implementing universal broadband service and, in turn, to identify market boundaries and determine the subsidy levels required to ensure a minimum level of connectivity for all households in the region.

## Bibliography

- Angrist, Joshua y Alan B. Krueger (2001), Instrumental Variables and the Search for Identification: From Supply and Demand to Natural Experiments, *The Journal of Economic Perspectives* 15(4): 69-85.
- World Bank (2008), *Global Economic Prospects: Technology Diffusion in the Developing World*, Washington D.C.
- Barrantes, Roxana, y Hernan Galperin (2008), Can the Poor Afford Mobile Telephony? Evidence from Latin America, *Telecommunications Policy*, 32(8): 521-530.
- Berkman Center (2010), *Next Generation Connectivity: A Review of Broadband Internet Transitions and Policy from Around the World*, Cambridge: Berkman Center.
- Cardona, Mélisande, Anton Schwarz, Burcin Yurtoglu y Christine Zulehner (2009), Demand Estimation and Market Definition for Broadband Internet Services, *Journal of Regulatory Economics* 35(1): 70-95.
- Chinn, Menzie, y Robert Fairlie (2006), ICT Use in the Developing world: An Analysis of Differences in Computer and Internet Penetration, *Review of International Economics* 18(1): 153-167.

- Cribbett, Peter (2000), *Population Distribution and Telecommunication Costs*, Australian Productivity Commission Research Paper, August.
- Dattaa, Anusua y Sumit Agarwal (2004), Telecommunications and Economic Growth: A Panel Data Approach, *Applied Economics* 36(15): 1649-1654.
- Ford, George, Thomas Koutsky y Lawrence Spiwak (2007), *The Broadband Performance Index: A Policy-Relevant Method of Comparing Broadband Adoption Among Countries*, Phoenix Center Policy Paper No. 29, Phoenix Center for Advanced Legal & Economic Public Policy Studies, July.
- Goolsbee, Austan, (2000), Subsidies, the Value of Broadband and Fixed Costs, en Robert Crandall y James Alleman (eds.), *Broadband: Should We Regulate High-Speed Internet Access*, AEI-Brookings Joint Center for Regulatory Studies, Washington, D.C.
- Hauge, Janice y James Priege (2010), Demand-Side Programs to Stimulate Adoption of Broadband: What Works? *Review of Network Economics* 9(3): 4.
- Horrigan, John (2009), *Home Broadband Adoption 2009*, Pew Research Center, Washington D.C.
- Katz, Raul (2009), *Estimating Broadband Demand and its Economic Impact in Latin America*, Presented at the conference REDECOM-ACORN, Mexico City, September.
- Koutroumpis, Pantelis (2009), The Economic Impact of Broadband on Growth: A Simultaneous Approach, *Telecommunications Policy* 33: 471-485.
- Marchionni, Mariana y Pablo Glüzmann (2010), *Distributional Incidence of Social, Infrastructure, and Telecommunications Services in Latin America*, CEDLAS, Universidad Nacional de la Plata.
- Milne, Claire (2006), *Telecoms Demand: Measures for Improving Affordability in Developing Countries*, Media@LSE, London.
- Rappoport, Paul, Donald Kridel, Lester Taylor y James Alleman (2002), Residential Demand for Access to the Internet, en Gary Madden (ed.), *The International Handbook of Telecommunications Economics: Volume II*, Edward Elgar Publishers: Cheltenham.
- Röller, Lars-Hendrik y Leonard Waverman (2001), Telecommunications Infrastructure and Economic Development: A Simultaneous Approach, *American Economic Review* 91(4): 909-923.
- Rosston, Gregory, Scott Savage y Donald Waldman (2010), *Household Demand for Broadband Internet Service*, Reporte Final al Broadband.gov Task Force, Federal Communications Commission, Washington D.C.
- Varian, Hal (2002), The Demand for Bandwidth: Evidence from the INDEX Project, en Robert Crandall y James Alleman (eds.), *Broadband: Should We Regulate High-Speed Internet Access*, AEI-Brookings Joint Center for Regulatory Studies, Washington, D.C.
- Wallsten, Scott (2009), *Understanding International Broadband Comparisons*. Technology Policy Institute, June.

## Annex V.1.

### Methodology for data collection

In order to analyse the quality of fixed broadband Internet access services and the tariffs charged for those services in Latin America and the Caribbean, a database was constructed by compiling all the service plans offered by the leading service operators in the major markets in the region.



The tariff survey was carried out using the criteria and methodology employed by OECD. Access plans advertising data download speeds exceeding 256 kbps were considered to be broadband. In each country, the universe of operators that was analysed included at least the leading provider of access via DSL and the largest provider of services via cable modem. Data were gathered during the second half of May 2010 and included 323 plans offered by 54 operators in 23 countries. The data correspond to the capital or main city in each country.

For each plan, information was collected on the technology used, download and upload speeds advertised, the type of contract, speed or data restrictions, and the corresponding tariffs in local currency (with and without tax). This information was obtained through web searches and telephone calls. Prices do not include charges for cable-television service or basic telephone service, which in some cases are a necessary condition for access to broadband services. Bundled services (double or triple play) were not considered, and tariffs do not include the modem rental. Based on the criteria used by OECD, list prices and discounted prices (monthly average for the first year of service) for a monthly subscription were computed.

Table A.V.1 details the plans and operators surveyed in each country.

Table A.V.1  
Plans and operators, by country

Country	Number of operators surveyed	Number of plans surveyed
Argentina	3	17
Belize	1	3
Bolivia (Plurinational State of)	4	40
Brazil	3	19
Chile	3	12
Colombia	4	37
Costa Rica	3	20
Dominican Republic	3	28
Ecuador	2	14
El Salvador	3	11
Guatemala	3	10
Guyana	1	3
Honduras	1	3
Jamaica	2	6
Mexico	3	11
Nicaragua	1	4
Panama	2	10
Paraguay	2	21
Peru	3	14

(continued)

Table A.V.1 (concluded)

Suriname	1	4
Trinidad and Tobago	2	9
Uruguay	1	13
Venezuela (Bolivarian Republic of)	3	14
<b>TOTAL</b>	<b>54</b>	<b>323</b>

Source: Prepared by the authors.

## Annex V.2.

### **Purchasing power parity (PPP) for price comparisons**

The first problem that arises when carrying out international comparisons is that the prices of the various plans are expressed in local currency units. The simplest solution is to convert them into a common currency using market exchange rates. The second problem is that, even when expressed in the same currency, price differences may be reflecting differences in price levels across countries, i.e., differences in the purchasing power of a dollar from one country to the next. Therefore, a second correction is needed. The standard way to eliminate differences in price levels between countries is to consider a purchasing power parity (PPP) index. The purchasing power parity between two countries, A and B, is the ratio between the number of units of country A's currency required to purchase a quantity of a good or service in country A and the units of country B's currency needed in country B to purchase the same amount of that good or service.

PPP rates are regularly used by international organizations, government agencies, universities, research institutes and journalists as inputs for economic analyses and public policy decisions involving a comparison between countries. They are also commonly used in comparisons of broadband prices (e.g., Berkman Center, 2010). In this chapter, we have used the index of purchasing power parity published by the International Monetary Fund (IMF) to convert all prices to PPP units in order to incorporate the differences in purchasing power across countries. Although prices in PPP can be expressed in the currency of any country, in practice, they are expressed in a single currency, most typically the United States dollar.

## Anexo V.3.

### **Estimating the demand for broadband**

The inclusion of the price of broadband access in a model that attempts to explain service penetration is not trivial, because the level of penetration

is determined by the interaction of the availability of the service, supply decisions and the demand for the service. Therefore, price and penetration are determined simultaneously; in other words, the price will be correlated with the error term in a regression of penetration on price and other explanatory variables.

If broadband demand and supply were to vary over time, observed penetration and prices would reflect a set of equilibrium points (i.e., intersections of broadband supply and demand). In that case, an OLS regression of penetration on price would not identify either the demand function or the supply function. In fact, if price is endogenous, the OLS estimation could yield inconsistent estimators of all the parameters of the regression.

The instrumental variable method provides a solution in the case of a single endogenous regressor. To correctly capture the effect of price on the demand for broadband, we need to find a factor that affects supply without affecting demand for the service; this type of factor is referred to as an instrumental variable or simply an instrument. The main objective is to isolate the exogenous variability (i.e., not caused by demand factors) in the price in order to estimate its impact on broadband demand.

The instrument must satisfy two conditions: (i) it must not be correlated with broadband demand, and (ii) it must be correlated with price. In other words, we seek a variable that affects broadband demand only through its effect on price. In this chapter, we use the density of households per square kilometre (*DENSHH*) as our instrumental variable.

Condition (i) is our identification assumption. It must be satisfied in order for the instrument to be valid but, as such, cannot be tested. Therefore, it should be maintained throughout the analysis. This assumption would be invalid if density affected broadband demand directly or through some channel other than price. For example, households in less densely populated localities (e.g., rural areas) may have less of a need for Internet than households in more densely populated areas (e.g., cities), in which case density would affect penetration directly, not only through price, thus invalidating the instrument. The identifying assumption implies that this does not happen.<sup>21</sup>

---

<sup>21</sup> Note that, in order to invalidate the instrument, households in areas with different densities would have to differ in regard to characteristics that impact broadband demand but that have not been included in the regression model.

Another potential problem concerns the density measure. As it is calculated at the country level, it is not immediately obvious that this variable captures what it is intended to capture (i.e., that it is cheaper to provide Internet in areas with higher household densities). To illustrate this, suppose that in a low-density country (such as Australia or Argentina), 99% of the population lives in densely populated urban areas. The cost of providing Internet would be relatively low, even though density at the country level would also be low. To address this problem, we performed estimations (not reported) using the percentage of urban population as an instrument. A priori, this would seem to be a better instrument, but also a much weaker one; in fact, the effect of price cannot be identified at the usual levels of confidence. Using this instrument in combination with our density measure did not lead to robust results either. Therefore, in spite of potential problems, household density has been used as our instrumental variable.

Regarding condition (ii), there is extensive evidence that density affects the cost of deploying telecommunications infrastructure (Cribbett, 2000). In an industry with large economies of scale, it is expected that a higher population density implies lower unit costs and therefore lower average prices. Unlike condition (i), this condition can (and should) be tested. We begin by verifying that there is a partial correlation between price and density, once the effects of other exogenous variables have been taken into account. We use the *t* test and the *F* test associated with the coefficient on *DENSHH* in the first-stage regression of the two-stage least squares (2SLS) estimation. Table A.V.2 shows the results of this first stage.

Table A.V.2  
Relationship between broadband price and household density (OLS)

Dependent variable: PRICE		
Variable	(1)	(2)
DENSHH	-0.480*** (0.146)	-0.262** (0.114)
GDPCAP		-0.0006 (0.0009)
AGE		-3.403 (3.668)
EDUC		-218.033 (250.586)
Constant	96.680*** (12.819)	528.059** (255.012)
Observations	51	51
F	10.83	5.32
Prob > F	0.0019	0.0256

Source: Prepared by the authors.

Notes: \*\*\* Significant at the 1% level.

\*\* Significant at the 5% level.

\* Significant at the 10% level.

Robust standard errors are indicated in brackets.

Both tests suggest that, conditional on the identifying assumption, the instrument is good (i.e., satisfies the condition (ii)), although it might be somewhat weak. The use of a single instrument for the endogenous regressor ensures that this problem, if it exists, is minimized. The *DENSHH* coefficient has the expected sign and is statistically different from zero at the 5% level.

As an additional check of the results, table A.V.3 shows the reduced form estimation, i.e., the OLS regression of penetration on all exogenous variables and the instrument (replacing price). The resulting estimates are unbiased, even if the instrument is weak, and it can be shown that the coefficient associated with the instrument is proportional to the effect of interest (price).

Table A.V.3  
**Broadband demand estimation: reduced form**

Variable dependiente: <i>PENET</i>		
Variable	(1)	(2)
<i>DENSHH</i>	0.119*** (0.025)	0.050*** (0.014)
GDPCAP		0.0005*** (0.0001)
AGE		-0.299 (0.220)
EDUC		68.046*** (22.805)
Constant	12.202*** (2.211)	-39.290** (16.817)
Observations	51	51
Centred R <sup>2</sup>	0.19	0.86
Uncentred R <sup>2</sup>	0.71	0.95

Source: Prepared by the authors.

Notes: \*\*\* Significant at the 1% level.

\*\* Significant at the 5% level.

\* Significant at the 10% level.

Robust standard errors are indicated in brackets.

The sign of *DENSHH* is again the expected one; as hypothesized, greater density implies a lower price, which encourages broadband demand. In absolute terms, the effect of price is smaller than that arising in the 2SLS regression, also as expected (see table A.V.2), but it is still highly significant.



## VI. The opportunities and challenges of mobile broadband

Ernesto M. Flores-Roux  
Judith Mariscal Avilés<sup>1</sup>

### A. Introduction

Thanks to the elimination or reduction of entry barriers to the ICT sector, as well as innovative business models, most of the world's population now has access to voice services. Mobile telephony provided a vehicle for even low-income sectors in developing countries to have connections to these services. In addition, low-income populations can use less sophisticated handsets to connect to the Internet and access general news and information (Samarajiva, 2009). Most 2G devices in use throughout the world do not, however, have capacity for searching or downloading complex information; that is, they are not capable of providing full access to all of the potential benefits of ICTs. That is why broadband access is a crucial issue for a majority of the world's population.

In Latin America,<sup>2</sup> significant progress has been made. In March 2010, there were 35 million high-speed Internet access connections over fixed networks in the region, predominantly DSL (66.7%) and cable modems (25.3%). This still falls short of what is needed, however. The majority of the population still does not have broadband access, and the average transmission

---

<sup>1</sup> The authors thank Fernando Ramírez for his valuable contribution in the preparation of this chapter.

<sup>2</sup> In this chapter, references to Latin America include the following countries: Argentina, Plurinational State of Bolivia, Brazil, Chile, Colombia, Costa Rica, Cuba, Dominican Republic, Ecuador, El Salvador, Guatemala, Honduras, Mexico, Nicaragua, Panama, Paraguay, Peru, Uruguay and the Bolivarian Republic of Venezuela.

speed for those who do is about 2 Mbps (Galperin and Ruzzi, 2010), which clearly limits their ability to reap many of the benefits of the Internet, including access to information about employment, health and governance.

Mobile broadband offers a unique opportunity to provide broadband access in developing countries. First of all, this platform does not require the substantial investment in infrastructure needed for fixed broadband deployment. And, in addition to not being dependent on customer-dedicated infrastructure, mobile broadband has another important advantage: its ubiquity. In fact, most of the population in the region already has access to mobile services (penetration exceeds 91%). In March 2010, 31.3 million mobile broadband connections were already in operation; this base is equivalent to more than 45% of Internet subscriptions (including dial-up connections) and more than 47% of broadband connections in the region. Countries such as Nicaragua, Ecuador, the Plurinational State of Bolivia and El Salvador have more mobile than fixed broadband connections.<sup>3</sup>

These statistics indicate that the preferred type of connection to the Internet in Latin America is via mobile broadband. Mobile broadband seems to be repeating the growth pattern followed by the mobile phone—which surpassed the number of fixed lines in 2001 and, 10 years later, has a service base more than five times larger—but at an even quicker pace. Moreover, the expansion of mobile broadband use will be even faster because people with lower incomes already have access to mobile services. In this context, it makes sense to consider what the region's main opportunities and challenges will be moving forward.

This chapter addresses these issues. First, the status of mobile broadband in the region is analysed; then, some of the opportunities opened up by this platform are reviewed; and, in closing, the main challenges and obstacles that must be overcome in order to allow its development to proceed at an even faster pace are discussed.

## **B. The status of mobile broadband in Latin America**

Mobile telephony has become the ICT with the highest level of penetration in the world. In late 2009, there were more than 4.6 billion active mobile phones (GlobalComms, 2010), which is more than four times more than the number of fixed telephone connections. In March 2010,

---

<sup>3</sup> In India, there are four times as many mobile netizens as fixed ones (Booz, Allen and Hamilton, 2007).



there were over 505 million active accounts in Latin America, representing a penetration rate of over 91%. This platform is therefore positioned to be one of the main vehicles for a wider dissemination and penetration of broadband services.

Latin America is in a much better position than most developing regions (see figure VI.1). In only three years (2007-2009), the number of mobile subscriptions rose by 200 million, and it continues to climb at a healthy growth rate (9.5% per year in the first quarter of 2010). This has allowed the region to surpass the penetration levels of the United States and Canada.

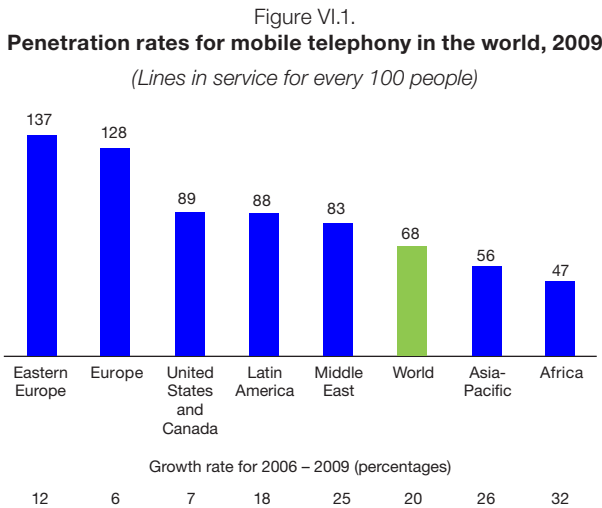

Source: GlobalComms (2010).

Mobile telephony has penetrated population segments that no other ICT has been able to reach (LAC, 2007). For example, in Mexico, mobile telephony is the dominant platform in all income brackets (INEGI, 2009, on the basis of data from 2008) and, in the poorest quintile, more than 30% of households had at least one mobile phone. In view of the fact that the subscription base has grown by over 15% since the survey was conducted (10.6 points of penetration), it is expected that, by the end of 2010, the penetration rate for this income stratum will exceed 40% (see figure VI. 2). In other words, mobile telephony is ushering in universal access to voice services.

Figure VI.2.  
**Penetration rate for telecommunications services, by income decile, in Mexico**  
*(Percentage of households with at least one connection)*

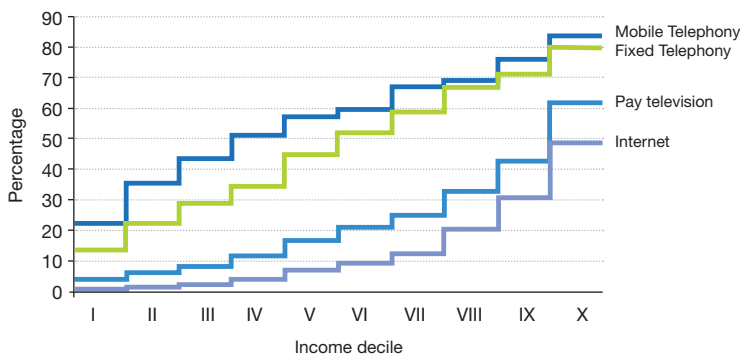

Source: ENIGH 2008, INEGI, 2009

The term “broadband” generally refers to fixed broadband. In March 2010, there were 35 million fixed connections, predominantly DSL (66.7%) and cable modem (25.3%), in Latin America. In less than 10 years, the region’s level of fixed broadband connections had grown so much that it matched the number of fixed telephone lines existing in mid-1993 and the number of mobile phones registered in the region in mid-1998 (ITU, 2010). These figures provide an incomplete picture of the situation, however, since, as of March 2010, 31.3 million mobile broadband connections were already in service, which was the equivalent of more than 45% of total Internet subscriptions (including narrowband dial-up connections) and more than 47% of the region’s broadband connections (see figure VI.3).

Figure VI.3  
**Internet connections in Latin America**  
*(Millions of subscriptions)*

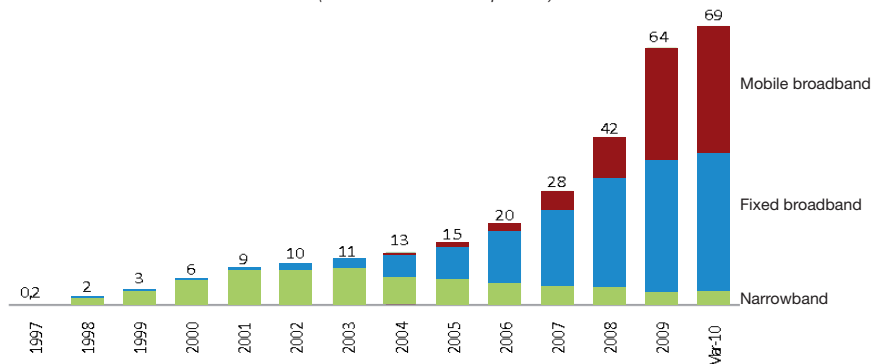

Fuente: ITU (2010) y Telegeography (2010)

Mobile broadband adoption is replicating, but more rapidly, the trend that was seen in mobile telephony 15 years ago. In 2001, 11 years after the mass launch of mobile telephony in Latin America, the number of mobile phone users had surpassed the number of fixed lines for voice service. In 2010, there were more than five times as many mobile lines as fixed lines. Just seven years after the launch of mobile broadband, there are already more than 0.8 subscriptions to mobile broadband for every fixed broadband subscription (see figure VI.4), and market estimates suggest that there will be more mobile broadband lines than fixed broadband by early 2011.

Figure VI.4  
**Ratio of mobile to fixed subscribers**  
*(Number of mobile subscribers for every fixed line in service)*

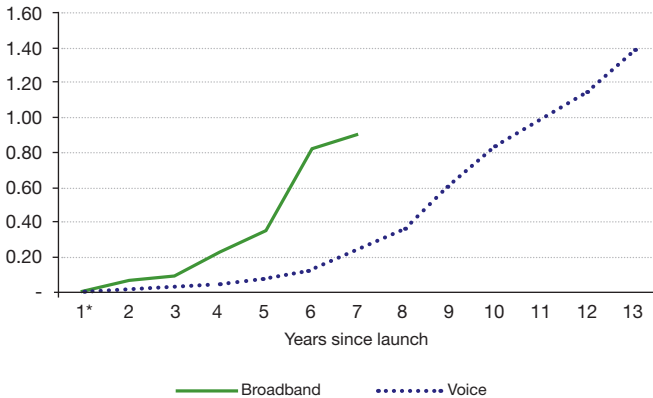

Source: Prepared by the authors with data from ITU (2010) and GlobalComms (2010).

\* 1991 for mobile telephony; 2004 for mobile broadband.

Note: The most recent data for each series (year 13 for voice, year 7 for broadband) are as March 2010.

All the evidence points to one conclusion: the preferred type of Internet connection in Latin America will be mobile broadband. This platform will make it possible to achieve broadband's universalization in much the same way as mobile telephony has become the nearly universal technology in use for voice services. Today, seven countries already have more mobile broadband connections than fixed connections (see figure VI.5).

Figure VI.5  
**Number of mobile broadband connections for every fixed broadband connection**  
*(March 2010)*

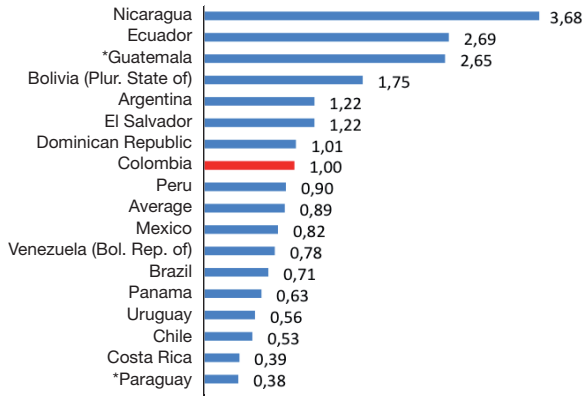

Source: ITU (2010) and GlobalComms (2010).  
 \*The data for these countries correspond to December 2009

As the mobile market continues to grow, the number of broadband connections, measured as a percentage of total subscriptions, is skyrocketing. In late 2008, only 2.3% of all mobile connections were broadband; in March 2010, they exceeded 6.2% of total subscriptions (see figure VI.6). The distribution by country is fairly homogeneous, with two exceptions: Cuba, where mobile broadband services were unavailable when this publication went to print; and Argentina, which has the most highly developed mobile broadband market in the region.

Figure VI.6  
**3G subscribers as a percentage of total mobile subscribers**

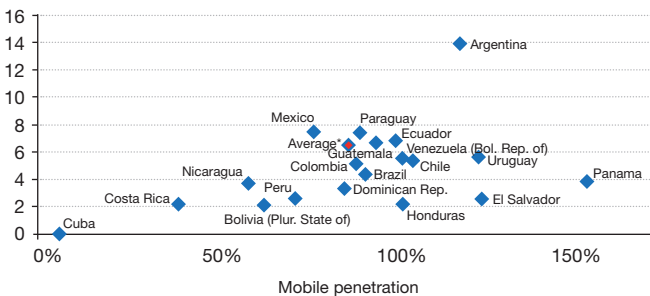

Source: ITU, 2010 and GlobalComms (2010).  
 \* Average mobile penetration in the region: 91%. Average mobile broadband penetration: 6.2%.

Most 3G network launches took place between 2007 and 2008 (see table VI.1), which was when several countries released additional spectrum or operators felt that the technology and the market were mature enough to begin to offer mobile broadband services at affordable prices.

Table VI.1.  
**3G networks in Latin America**  
(Selected countries)

Country	Operator	Platform	Frequency (MHz)	Launch year
Argentina	Claro Argentina	W-CDMA	1900	2007
Argentina	Telecom Personal	W-CDMA	1900	2007
Argentina	Telefónica Móviles (Movistar)	W-CDMA	1900	2007
Brazil	Algar Telecom	W-CDMA	2100	2008
Brazil	Brazil Telecom (BrT)	W-CDMA	-	2008
Brazil	Sercomtel Celular	W-CDMA	-	2008
Brazil	Telecom Americas (Claro)	W-CDMA	850	2007
Brazil	Telemar Norte Leste (Oi)	W-CDMA	2100	2008
Brazil	Telemig Celular	W-CDMA	2100	2007
Brazil	Telemig Celular	W-CDMA	850	2007
Brazil	TIM Brazil	W-CDMA	850	2008
Brazil	TIM Brazil	W-CDMA	2100	2008
Brazil	Vivo Participações	CDMA2000	800	2004
Brazil	Vivo Participações	W-CDMA	2100	2008
Chile	Claro (antes Smartcom)	W-CDMA	1900	2008
Chile	Entel PCS	W-CDMA	1900	2006
Chile	Telefónica Móviles (Movistar)	W-CDMA	1900	2007
Colombia	Colombia Móvil (Tigo)	W-CDMA	2100	2008
Colombia	Comcel (América Móvil)	W-CDMA	850	2008
Colombia	Telefónica Móviles (Movistar)	W-CDMA	2100	2008
Mexico	Iusacell (including Unefon)	CDMA2000	800/1900	2005
Mexico	Telcel (América Móvil)	W-CDMA	850/1900	2008
Mexico	Telefónica Móviles (Movistar)	W-CDMA	850/1900	2008
Peru	América Móvil Perú (Claro)	W-CDMA	850	2008
Peru	Nextel del Perú	W-CDMA	1900	2009
Peru	TEM Perú (Movistar)	W-CDMA	2100	2009
Peru	TEM Perú (Movistar)	CDMA2000	800	2004

Source: GlobalComms 2010.

The adoption of mobile broadband has been spurred by a significant decrease in the price of terminal devices thanks to worldwide economies of scale.<sup>4</sup> However, the cost of service continues to be high in Latin America, and this will probably result in a slowdown in adoption unless prices can be brought down. On average, monthly service costs around US\$ 63 per month, but with very significant differences across countries. For example, in Peru, a monthly subscription of at least 1 GB costs about US\$ 50 while, in Uruguay, it

<sup>4</sup> According to Buttkeiret et al. (2009), the price of mobile devices affording broadband access is around US\$ 25 in the United States.

costs about US\$ 20 (see figure VI.7). As the amount of data to be transferred increases, the differences become even more pronounced (US\$ 74 and US\$ 24, respectively).

Figure VI.7.  
Average fixed cost of monthly plans of mobile broadband  
(US dollars per month)

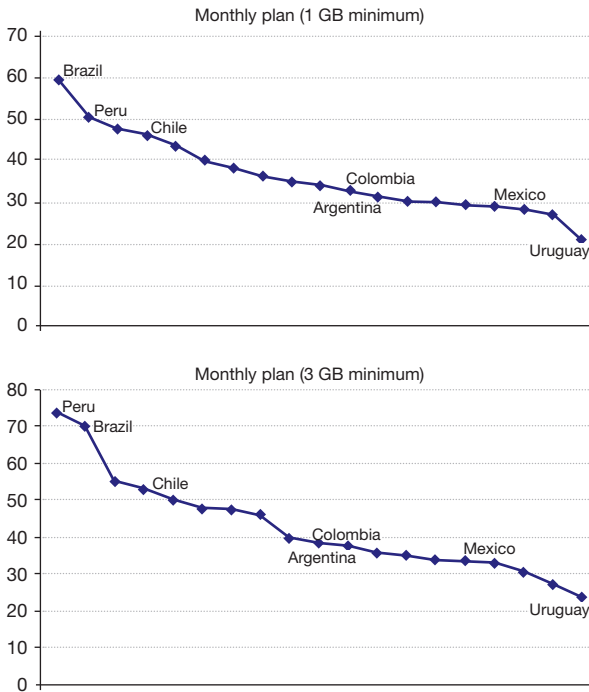

Source: Galperín and Ruzzier (2010).

Recently, operators in the region have begun to offer prepaid mobile broadband services.<sup>5</sup> While the introduction of this service has been gradual, it is expected that, before long, all Latin American operators will be offering both postpay and prepaid plans.

<sup>5</sup> Operators offering prepaid mobile broadband services: Argentina: Claro and Movistar; Brazil: TIM, Vivo and Claro; Chile: Movistar, Entel PCS and Claro; Colombia: Comcel, Movistar and Tigo; Mexico: Telcel, Movistar and Iusacell; Peru: Claro and Movistar.

In order to fully understand the status of mobile broadband and its possible future course of development, the current relationship between Internet users and the existing infrastructure needs to be examined. Internet penetration has grown steadily over the past 10 years,<sup>6</sup> and, as of 2010, the Internet was being used by almost one out of every three people in Latin America. However, year-on-year growth rates have been declining, and a period of rising rates such as that seen in mobile telephony between 2003 and 2006 has not yet been observed (see figure VI.8). The rapid growth of the base of connections, paired with the linear growth of the user base, has meant that the number of users per connection is declining significantly. There are two reasons for this shift. On the one hand, broadband access is becoming individualized: access is increasingly private, especially in the residential sector, and the relative importance of community access centres and other access groups (businesses, offices, universities, schools) has declined. On the other hand, with the advent of mobile broadband, the number of people with more than one broadband connection has increased significantly (see figure VI.9).

Figure VI.8.  
**Internet penetration in Latin America: annual growth rates**  
(Percentages)

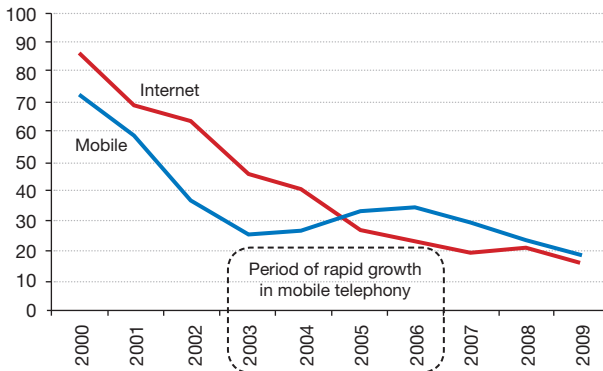

Source: ITU (2010); Internet World Stats (2010) ([www.Internetworldstats.com](http://www.Internetworldstats.com)).

\* Moving tri-annual average growth rates.

<sup>6</sup> Based on information reported by countries to ITU. Penetration is usually measured by determining the number of people who have accessed the Internet in the last 12 months. This information was supplemented with data from Internet World Stats ([www.internetworldstats.com](http://www.internetworldstats.com)) (2010).

Figure VI.9.  
Number of users per Internet connection

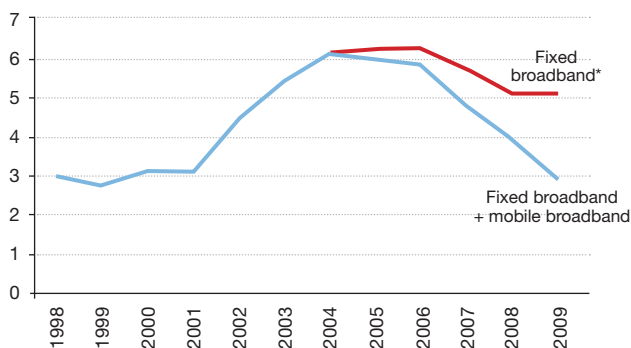

Source: ITU (2010); Internet World Stats (2010) ([www.internetworldstats.com](http://www.internetworldstats.com)).

\* Includes dial-up connections (narrowband), of which there were fewer than 3 million at the end of 2009.

In this context, mobile broadband opens up major opportunities for development, but it also poses challenges. There are more questions than answers at this early stage of the platform's development, and the level of benefits which trickle down to society will most likely depend on how effectively the region meets those challenges. Is it possible that mobile broadband will enable Latin America to succeed in becoming a full member of the information economy, just as mobile telephony allowed it to do in the case of basic voice services? Is it possible that mobile broadband will turn out to be what finally drives an acceleration in the adoption and appropriation of Internet in the region?

### C. Mobile broadband: an opportunity for development

ICTs offer new opportunities for economic and social development, as has been clearly illustrated by the advent of mobile telephony. The cost structure of this service has made access feasible for marginalized segments of the population in cities, as well as people in geographically isolated areas. On the one hand, fixed telephony's local loop is a dedicated resource for each subscriber, so the cost lever is the connection cost rather than its use. On the other hand, mobile telephony—a radio base connection, which is equivalent to the loop—is shared, so the cost lever is its use rather than the connection. This is the main reason why operators can offer variable subscription plans based on new business models such as prepaid service. Moreover, fixed networks still operate mainly over copper infrastructure, which makes them prone to multiple



technical problems (Buttkereit et al., 2009): continuous maintenance is required along the entire cabled network, they are subject to service interruptions due to weather and poor urban infrastructure, and they are vulnerable to theft and vandalism. Mobile networks, on the other hand, can dispense with a significant part of the physical infrastructure, at least with regard to the local loop.

Technological advances are also increasing the amount of information that can be transmitted over a limited part of the spectrum, although it is true that these advances are now approaching their theoretical limits. Be that as it may, this fact, along with the possible cellular reuse of spectrum, generates greater economies of scale in the operation of a mobile network.

Mobile broadband offers a range of opportunities for the development of a more equitable, skilled, productive and competitive society. Internet, accelerated by the advent of fixed broadband, created a positive discontinuity in the democratization of information. However, this wave of change bypassed most emerging countries, including those in Latin America, and, as a result, they have not become fully integrated into the globalized world. Mobile broadband once again presents a discontinuity which, given its characteristics, can be exploited to reduce the digital exclusion of the region. Thus, the conditions are in place to generate a virtuous circle of growth and incorporation into that globalized world.

The social and economic effects of mobile broadband can be assessed from two perspectives. On the one hand, mobile broadband can be seen as a substitute for fixed broadband. On the other hand, it can be understood within a context where both access modes complement each other by servicing different market segments.

### **1. *Opportunities for mobile broadband as a substitute for fixed broadband***

Mobile broadband—an almost perfect substitute for fixed broadband—can deliver all of the same economic and social benefits which have been discussed in other chapters. In this chapter, we highlight three effects of broadband penetration based on the assumption that mobile broadband will become the main modality for the achievement of universal access.

**Higher economic growth:** Investment in mobile broadband and network deployment has a direct and immediate impact which has a multiplier effect on the producers of equipment and content. It helps boost firms' productivity by allowing them to adopt more efficient processes and to save resources

through outsourcing (Katz, Flores-Roux and Mariscal, 2010). In addition, its use accelerates innovation through the introduction of new services and increased human capital formation. Several empirical studies have measured the impact of broadband penetration on GDP growth (for a discussion of the findings in this respect, see chapter 2 of this book).

**Promoting social inclusion:** The increased access to information that is provided by broadband reduces the digital gap and is becoming an important tool for creating opportunities at all levels of society. The creation of more and better opportunities has a significant impact on social inclusion and reduces the concentration of wealth.

**Potential for improving the quality of education:** Although there is an ongoing debate as to the extent to which ICTs contribute to improved student performance and the best approaches for ensuring that they have the most effective impact possible, numerous initiatives are being undertaken around the world to incorporate these technologies into education, starting with a massive deployment of connectivity. Mobile broadband, the existence of other wireless networks (e.g., femtocells, WiFi and WiMAX technologies) and the popularization of intermediate access devices (e.g., e-reading devices such as Kindle, which is a cross between a computer and a mobile phone, or the multi-use iPad) may make a substantial contribution in this area.

## ***2. Opportunities for the use of mobile broadband as a complement to fixed broadband***

The uses that can be made of mobile broadband as a substitute for fixed broadband are certainly important, but these technologies will have an even greater impact if they are viewed as complementary services that can be deployed in different market spaces, as each platform has different attributes. Complementarity is possible because of three characteristics of mobile broadband that distinguish it from fixed broadband: (i) it is mobile, (ii) it is ubiquitous, allowing access to the Net from virtually anywhere, in much the same way as now occurs with mobile telephony, and (iii) it has a cost structure in which variable costs are dominant and depend almost entirely on consumption.

These three seemingly simple characteristics have the power to generate an infinite host of additional benefits and opportunities. Each gives rise to an area of opportunity that is inherent in mobile broadband: (i) the democratization of access to information (in principle, the Internet), (ii) an acceleration of appropriation and the attainment of digital literacy, and (iii)

the incorporation and utilization (including real-time access anywhere) of the applications and information needed by private companies and governments to carry out transactions.

**(a) Democratization of access**

As discussed in the first section, mobile broadband will play an important role in enabling millions of people to have Internet access. It will be the predominant form of Internet access throughout the region and will make the benefits of broadband available to a majority of the population: it will thus serve as the primary means of democratizing ICTs.

The underlying reason for this is that mobile broadband, unlike fixed broadband, has a cost structure based on variable costs, i.e., the main driver of costs is consumption. This means that virtually every customer is profitable, because if a customer does not consume, no costs are generated (see figure VI.1). Given this fact, combined with the steady decline in the price of terminal devices, more and more people may opt for this mode of access. Operators providing wireless broadband service will therefore increasingly focus on launching services with low entry barriers and minimal maintenance requirements, allowing customers to pay only for what they consume. The availability of these services will generate a demand which, although small in terms of each customer, will, in the aggregate, represent a volume that will bear the costs of deploying and operating the network.

Figure VI.1.

**Comparison of the cost structure of broadband modalities**

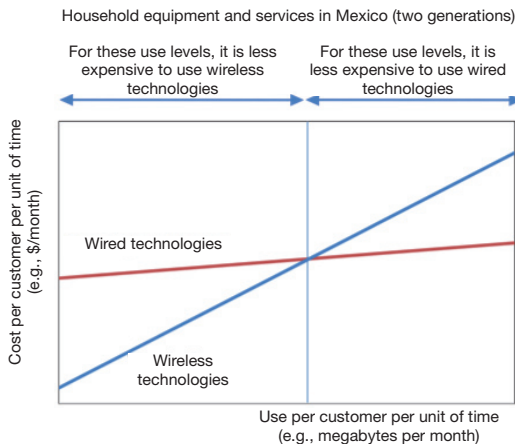

Source: Prepared by the authors based on Booz & Company.

### **(b) Positive discontinuity in the appropriation of Internet**

A widespread incorporation of the Internet into people's daily lives has not yet occurred in Latin America. Only one out of every three Latin Americans used the Internet in 2009 (ITU, 2010; Internet World Stats, 2010). In other words, the appropriation of this technology on a mass scale has still not occurred. There are several reasons for this, with the most important of them being the cost of the service, which reduces affordability; the lack of the types of content and applications needed to meet basic, everyday needs; and the fact that large segments of the population do not know how to use this technology (digital illiteracy), which is probably the greatest barrier.

Individual services with network effects tend to be adopted rapidly, as has occurred not only with mobile telephony but also with social networks like Facebook and online messaging services such as ICQ, QQ, Microsoft Messenger and BlackBerry Messenger. Virtually the entire population can use a mobile phone; the fact that basic mobile broadband services are offered on familiar devices with an almost universal presence will facilitate the adoption of Internet and its incorporation into daily life. Mobile broadband is positioned to become an important element in the development of digital literacy, given that the learning curve involved in mastering its use is substantially less steep than it is in the case of computer use. It will therefore help to bring down one of the main barriers to Internet adoption by acting as an intermediate step in the acquisition of digital literacy and ownership.

### **(c) Real-time access to information and content anywhere**

In order to carry out any transaction, information must be accessed or generated and stored for later recovery and use. Most business processes, as well as interaction within the government and between governments and citizens, require the exchange of information. If the exchange is simple, it usually can be conducted in real time. However, more complex information exchanges involve several steps, each of which may take hours, days or sometimes even months. These processes tend to be inefficient and to generate transaction costs. Mobile broadband can substantially reduce such costs in situations where the possibility of exchanging information in real time from any location generates significant efficiencies in processing the transaction.

Many examples of these sorts of situations can be found in private enterprise and the related business processes, as well as in the public domain. These types of cases can be sorted into three categories:

- Transactions of goods and services that rely on large amounts of information or time-sensitive information or that require data storage

(e.g., customer information, product information, inventory updates or management, development and sale of custom products). A case in point is door-to-door sales and the management processes (insurance, package delivery) and services related to such sales (incident reports for insurers, real-time tracking of packages, delivery, post-sales and inventory management). All these activities can be conducted much more efficiently by sharing information in real time, and many of them do not require the physical movement of people to complete the process.

- A government's relationship with its citizens (e.g., identification of citizens in various situations, citizens' requests for information of a public nature and citizen participation). This category includes public safety initiatives that permit the rapid identification of persons or property (e.g., vehicle registrations), the right to access information in a timely manner, regardless of location and time, and elections and plebiscites, among many other mobile e-government initiatives.
- Ongoing services relating to a person or object that is in transit which require a constant exchange of information. This category includes many health initiatives, remote monitoring, advertising and tracking services.

Mobile broadband opens up opportunities for building applications that will dramatically change how people, businesses and government interact. In the future, the imagination and creativity of developers will generate applications designed to meet increasingly specific needs. These applications will make it possible to:

- Make the delivery of health services more flexible thanks to the capability for the mass transmission of data (images, medical records, drug inventory management) and remote patient support, which will improve patient care and outcomes while reducing costs.
- Improve the efficiency of services designed to ensure public safety and security which depend on the transmission of data and information, independently of location.
- Increase the effectiveness of programmes aimed at combating poverty and promoting social inclusion (see box VI.1) through their real-time management in marginal areas, which will lower costs, produce positive impacts in less time and reduce the resource waste.
- Generate demographic and market information in a timelier manner by permitting census and sampling results to be fed into a database in real time. This will permit information to be made available much more quickly than at present.

- Increase the efficiency of public or private services that depend on the fieldwork of service personnel.
- Strengthen social networks, which are an engine for the development of digitally literate societies.

Mobile broadband opens up a wide range of possibilities beyond those offered by fixed broadband. In order to take advantage of them and translate them into increased public well-being, public policy will have to operate on the assumption that mobile broadband will be the priority mode of access and that it will be the job of entrepreneurs and innovators to ensure that this instrument achieves its full potential. Public policies should therefore focus on eliminating entry barriers and providing incentives for progress in this area.

#### **Box VI.1.**

##### **Mobile broadband and its use in anti-poverty programmes**

Broadband, whether fixed or mobile, helps to promote social inclusion. An example of one valuable application of mobile broadband is its use in the management of programmes aimed at combating poverty to improve not only programme targeting but also programme monitoring and oversight. The two largest-scale initiatives to fight poverty in Latin America are the Mexican Oportunidades programme and the Bolsa Familia in Brazil. Under these programmes, State financial support for mothers is conditional upon their fulfilment of certain obligations (e.g., ensuring that their children attend school and receive a full course of vaccinations). Two of the major challenges for these programmes have had to do with identifying suitable beneficiaries and ensuring the proper delivery of cash benefits. Pilot programmes have already been launched in which field operators are in direct contact with a central office through devices equipped with wireless broadband. Field operators can assess potential candidates' profiles; sign them up for the programme on the spot or disqualify them, as the case may be; make changes in the records on their status, address and number dependents; and notify the central office in real time that programme obligations have been met. As a result, processes that used to take several months can be completed in minutes. This possibility has substantially increased the efficiency and equity of these programmes and creates incentives for compliance with programme obligations, as well as reducing the chances of inappropriate resource use and the possibility of fraud.

The delivery of resources via fully electronic media is still in the research phase, but a faster data connection will allow more rapid and efficient delivery of funds. Although the region's mobile banking efforts have met with little success, the delivery of funds through electronic means is expected to have a major impact on the economy by promoting the use of banking services and decreasing the likelihood of fraud and crime. It will also reduce the number of cash transactions, which will promote the formalization of the economy and make money laundering more difficult.

## **D. Challenges in taking advantage of the potential of mobile broadband**

In order to exploit the opportunities discussed above, a suitable regulatory framework for the promotion of technological convergence is needed. One of the main tasks is eliminating entry barriers to the sector, which are prevalent in almost all of Latin America in terms of institutions, interconnection of networks, processes for granting licences and permits, spectrum availability and the development of infrastructure.

### **1. Institutional barriers**

Economic regulatory action has the complex task of influencing companies' behaviour in ways that will ensure its compatibility with the public interest.<sup>7</sup> Regulatory agencies seek to provide incentives to improve corporate performance through the rules, regulations and contracts that they establish. To a large extent, their chances of success are determined by the effectiveness of the institutions responsible for regulatory policy design and implementation. In order for the regulatory process to be successful, sound institutions are therefore needed that are capable of issuing transparent, predictable and credible policies. In Latin America, the first entry barrier to the sector is related to its institutional weakness, which does not allow it to generate the necessary legal certainty for investment. Regulatory processes should provide for public hearings to inform the community about ongoing developments and to ensure that the views of stakeholders are taken into account. They also need to provide for transparent policy design and implementation procedures. For mobile broadband, the institutional process of granting licences for the use of radio spectrum (discussed below) is of particular importance. In institutional terms, these processes have moved very slowly, with years going by between one spectrum auction and another, and this has created an artificial scarcity of spectrum. Moreover, in many cases, the auction process has lacked transparency and flexibility and has been overly demanding in terms of eligibility for awards.

---

<sup>7</sup> The concepts of public interest and social welfare are not only difficult to measure but are also difficult to define in general terms. For the purposes of this analysis, "public interest" is understood to mean the process by which regulatory objectives are defined. An inclusive and open regulatory process that seeks to benefit the majority of the stakeholders in the community is compatible with the public interest.

## **2. Interconnection**

A number of Latin American countries' experiences in the area of interconnection have been quite similar, and interconnection is included in most of the telecommunications laws or regulations as a mandatory process. Most countries (for example, Peru, Argentina, Chile and Brazil) have interconnection rules that deal with technical, economic and legal issues. One of the most notable exceptions is Mexico, where the rules for interconnection were published 15 years after the telecommunications law was enacted and have been legally challenged by practically all of the companies involved.

Interconnection allows the system to work seamlessly and is the main lever for the transfer of value between companies in the sector. The conditions governing interconnections determine the market structure and the degree of competition. In virtually all countries, operators are allowed to negotiate rates freely, and a cost-based methodology has been the preferred way to calculate rates, especially in cases of intervention by regulatory authorities. Since interconnection pricing and conditions are the most influential variables in terms of the proper operation of the system, it would have been more effective to determine them, insofar as possible, beforehand, which would have left fewer issues open to further negotiation and reduced the need for subsequent conflict resolution mechanisms. However, this has not been the case, and interconnection has been a highly contentious issue, not only in Latin America, but virtually the world over, and has proven to be the most formidable barrier to telecommunications development.

Packet transmission technologies and, more specifically, technologies based on Internet protocol, offer a unique opportunity for achieving a sound form of market development that focuses on social welfare. Innovative models for promoting investment and competition should be sought that will avert the numerous lawsuits that are currently hampering development.

This is the time to rethink interconnection. Current interconnections with standards based on time-division multiplexing which target and are tailored to circuit-switched networks are not properly aligned with the performance and economic aspects of packet-switched networks (Hirsch, 2010). New models should be considered with a view to determining the feasibility of arriving at a model equivalent to the peering arrangements existing among tier 1 networks on the Internet. For situations where the balance of costs and traffic is similar, it can be determined whether it makes sense to establish a "bill and keep" system, in which operators do not pay for interconnection; this is equivalent to paying in kind (an operator pays for the termination of its traffic on another



network with the termination of the traffic from the other network on its own network). It is also important to consider how these models affect the viability of low-use consumers, especially in the case of outbound traffic.

The efficiency of retail price structures for end users and the distribution of network costs depend on the kind of interconnection arrangement that is in place. There is no single model of efficient interconnection, as the choice depends on the context, but it is clear that the increased capabilities of next-generation networks will allow for a better ratio between wholesale and retail prices.

### **3. *Process for granting licences, permits and concessions***

Several countries have launched a new generation of deregulation policies designed to promote convergence. These policies include a new licensing strategy that gives operators the freedom to offer all the services that their technology platforms enable them to provide. Within the region, Argentina, Peru, Guatemala and El Salvador are among the countries currently granting licences that allow operators to supply any telecommunications service that they wish to offer, thereby promoting greater competition.

However, these are isolated cases in the region. Many countries in the region continue to employ discretionary processes for granting licences or impose numerous restrictions and conditions. The most efficient strategy would be to grant licences or concessions on an objective basis and to do so swiftly, without introducing additional conditions or discriminatory tenders. During the bidding process, coverage and economic benefits should be taken into consideration.

### **4. *Spectrum availability***

Spectrum is the most indispensable resource for the provision of mobile broadband services. The way in which it is made available to the market—through auctions or mechanisms such as direct allocation—is the most important aspect of regulatory policy in terms of the development of the sector. Although regulatory institutions in Latin America are beginning to release more of the spectrum to mobile operators, the percentages involved are still quite small when compared to those of countries with more developed and competitive telecommunications sectors (see figure VI.10). The deployment of new generations of mobile services is limited by the amount of spectrum available.

Figure VI.10.  
**Spectrum available for mobile operators, 2010**  
 (MHz)

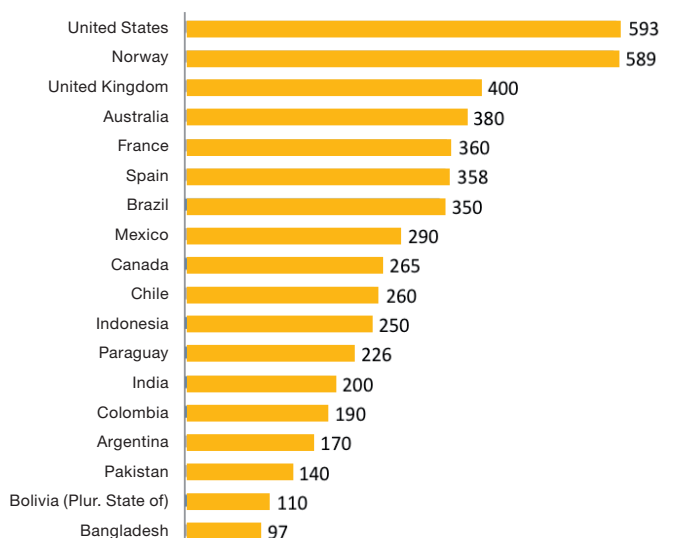

Source: Cabello (2010)

A preliminary analysis of four Central American countries that are relatively similar in terms of the size of their economies and their levels of development points up a negative association between the amount of spectrum allocated, on the one hand, and prices and market concentration, on the other, as the more spectrum that is granted at auction, the lower prices and concentrations turn out to be (see table VI.2). El Salvador and Guatemala have auctioned off more spectrum and display better performances in terms of price and concentration. To obtain a robust result, an analysis covering more countries would have to be carried out over a longer period of time.

Table VI.2.  
**Average price of mobile broadband, allocated spectrum and market concentration, 2010**

	Average fixed cost of a plan per day (US dollars)	Allocated spectrum (MHz)	Concentration (Herfindahl- Hirschman Index)
El Salvador	1,98	210	2686
Guatemala	2,50	172	3494
Panama	5,00	130	3747
Nicaragua	5,74	90	5333

Source: Prepared by the authors on the basis of DIRSI (2010), GlobalComms (2010) and Cabello (2010).

These preliminary results are consistent with the findings of other studies that show that the spectrum management policies implemented in El Salvador and Guatemala have generated benefits for consumers. El Salvador carried out a major reform process in 1996-1997 in which it recovered and reallocated frequency bands that were idle and allowed a more flexible use of the spectrum. These policies have resulted in an increase in the number of competitors and a significant decrease in prices, which has boosted the sector's efficiency (Hazlett, Iburguen and Leighton, 2007). To date, El Salvador has five operators and one of the lowest levels of concentration (2686 as of 2009), as well as one of the highest levels of penetration (128.8% as of March 2010). However, the lack of scale and the low purchasing power of the population have slowed the mass deployment of mobile broadband networks, and the percentage of the total base of mobile telephony represented by mobile broadband users is the lowest of all (2.2% as of March 2010).<sup>8</sup>

Guatemala is one of the paradigmatic cases of a government allocation policy. The General Telecommunications Act of 1996 removed the regulatory constraints that had prevented operators from making extensive use of the available spectrum (Hazlett, Iburguen and Leighton, 2007). Guatemalan law allows operators to apply for the blocks of spectrum that suit them before the bidding is opened, without the authorities intervening to assemble these blocks beforehand or to determine their use. The trade-offs between different uses are therefore managed by the licensees themselves, without regulatory intervention.

Guatemalan law revolutionized spectrum management policies, as it was developed along two innovative lines. First, it established that bands of spectrum were to be made available to those who applied for them for the purposes that the applicants themselves defined. It also established usufruct property rights, and operators could therefore modify the type of use that they made of their assigned radio spectrum over time. These rights include the ability to sell or lease the allocated spectrum for the benefit of others, which led to the development of an emerging secondary market for spectrum bands. These rights were institutionalized through the establishment of usufruct frequency titles.

Until a few years ago, Guatemala was the country with the highest largest amount of available spectrum in the region, but it has begun to lag behind since then (currently 192 MHz). However, the use of that spectrum is reflected in a

---

<sup>8</sup> Apart from Cuba, where, as of 2010, these services were unavailable.

wider range of services, lower prices, faster deployment of mobile broadband services (proportionally, it is the fourth-largest user base in the region, after Argentina, Mexico and Paraguay) and significant gains in consumer surplus (Hazlett, Ibarguen and Leighton, 2007). One of the crucial factors in these policies is a change in the underlying axiom for the regulation of the sector whereby property rights are granted to portions of the spectrum.

The migration from analogue to digital terrestrial television gives rise to a major discontinuity in terms of the development of mobile telecommunications: the so-called “digital dividend”.<sup>9</sup> In order to conduct a cost-benefit analysis of the use of this spectrum for mobile services or for radio broadcasting services, it becomes necessary to determine which of the two will generate more social welfare. Several studies (Value Partners, 2009; Analysis for ARCEP Mason, 2009) show that the optimal allocation of spectrum in terms of social well-being apportions the larger share to telecommunications services. Releasing the 700 MHz band, previously assigned to radio broadcasting services, would provide an additional 180 MHz. A calculation of social cost-benefits indicates that the social benefit of reallocating this spectrum would amount to between US\$ 1.17 and US\$ 1.23 per MHz per person (Muñoz, 2009). In another study, Hazlett and Muñoz (2009) found that an increased release of spectrum in the six largest markets in Latin America would result in significant social benefits, with an increase of 20 MHz resulting in direct benefits equivalent to about US\$ 54 per capita.

GSMA, a private business association of mobile operators and other stakeholders (2009), also provides arguments for a greater allocation of spectrum to mobile technologies, given that the efficient use of GSM technology has significant effects on economic variables such as productivity, innovation, employment and competitiveness.

The digital dividend provides a valuable opportunity for achieving greater broadband coverage in the region. In Latin America, however, the situation has not yet been clearly resolved. The timetable for the so-called “analogue blackout” (the switching off of analogue television) continues to be extended (see table VI.3). The discussions have, in part, focused on the standard, but the important point is that transition dates are being put back by at least five years, which also delays the realization of the digital dividend.

---

<sup>9</sup> The “digital dividend” refers to the amount of spectrum that will be freed up in the switchover from analogue to digital terrestrial television. Digital television uses the spectrum six times more efficiently than analogue television does, which makes it possible to reassign spectrum to other services without compromising open television (European Union, 2010). See [http://europa.eu/legislation\\_summaries/information\\_society/l24114\\_en.htm](http://europa.eu/legislation_summaries/information_society/l24114_en.htm)

Table VI.3.

**Decision date regarding the standard for digital TV and the analogue blackout**

Country	Decision date regarding the standard	Date set for the analogue blackout
Argentina	8/2009	2019
Bolivia (Plurinational State of)	5/2010	Undefined
Brazil	6/2006	2016 (but could be extended)
Chile	9/2009	2017
Colombia	8/2008	2017
Costa Rica	4/2010	2018
Ecuador	3/2010	Between 2016 and 2020
El Salvador	4/2009	2018
Mexico	7/2004	2015
Paraguay	6/2010	Undefined
Peru	2/2009	2023
Uruguay	8/2007	Undefined
Venezuela (Bolivarian Republic of)	9/2009	2019

Source: Regional Technical Telecommunications Commission for Central America (COMTELCA) and regulatory agencies in each of the countries.

In this context, three scenarios are possible. First, the band may not be reassigned, remaining under the control of the radio broadcasting industry; this would run counter to the interests of a proper form of management of spectrum and international trends. Second, the band could be assigned later on, but this approach significantly delays the possibility of seizing a unique opportunity to make a better use of a scarce State-owned resource and therefore incurs a high cost in terms of social welfare. Finally, it is possible and advisable to reassign the 700 MHz band without waiting for the “analogue blackout”. This third scenario is feasible because the UHF band is barely used for radio broadcasting services in the region. For example, in Chile, only 7 of the 48 licenses available in the metropolitan area are in use. In Argentina, the band of 512 MHz to 806 MHz is hardly used. In Mexico, the 700 MHz band has only 11 television broadcasters, all in cities in states bordering the United States.

Therefore, unlike countries where the use of 700 MHz is subject to an orderly transition, the impact of reallocation in Latin America would be much smaller. There is no reason to postpone the use of this spectrum in the region; its reallocation should be one of the short-term priorities in most countries.

## **5. Infrastructure availability**

The deployment of telecommunications infrastructure is one of the crucial elements for increasing competition among suppliers and generating higher service penetration. Appropriate legislation for encouraging competition, an abundant supply of radio spectrum and suitable interconnection agreements

are necessary to achieve greater efficiency in the sector. However, if the available infrastructure falls short of what is needed, these other measures will not be enough. The availability of modern communications networks at affordable prices is a determinant for the entry of new companies in local markets.

To address the infrastructure deficit, three levels of infrastructure must be considered: inter-urban transport networks (backbone), urban transport networks (backhaul) and local networks.

The presence of long-distance transport networks and their access to the Internet are essential in order to ensure the efficient provision of mobile broadband services at reasonable prices. Different countries have adopted different models, but all have focused on promoting competition and the duplication of infrastructure. Countries such as Australia, the Republic of Korea, South Africa and Mexico have taken this path. Brazil has opted for a mixture of the infrastructure provided by traditional carriers with an exchange of “universalization” obligations (obligatory backbone connections to take the place of the installation of public telephones, especially in smaller towns), the reactivation of Telebrás and an investment of US\$ 8 billion to build open networks.

Very little attention has been devoted to the problem of urban transport networks in the region. In cities, there are several alternatives, but a lack of investment in this segment of the network, along with difficulties in obtaining *rights-of-way*, posts, *ducts* and conduits, is likely to generate a bottleneck in the short term. Policies should be directed towards promoting investment in this segment before these shortfalls come to represent serious constraints for the development of mobile broadband.

Finally, the availability of infrastructure in the “last mile” has been one of the most contentious issues of debate for over a decade now, with the controversy mainly focusing on the question of “local loop unbundling”. In the case of mobile telephony, the debate has dealt with two main facets: the resellers of services (commonly referred to as mobile virtual network operators, or MVNOs) and the sharing of certain types of infrastructure (especially the towers).

Operators with large market shares do not view the possibility of operating as an MVNO as an attractive proposition and generally rule it out. However, for smaller operators, it is a way to make better use of their infrastructure without doing any great harm to their market share. For example, in Mexico this modality is offered by Movistar. Another example is Maxcom, a company that originally offered fixed services but that now offers integrated services (triple or quadruple play) using Telefónica’s mobile network to supplement its own network.

Sharing towers reduces investment costs as well as having a lower environmental impact. The introduction of this model has made slow progress in the region, but it is becoming an increasingly relevant option, as the ownership of the towers is of little strategic value and does not represent a sustainable competitive advantage once coverage is competitive. If this situation is not resolved by regulation, it will be determined by the market, which is, in fact, already beginning to do so.

## E. Conclusions

This chapter has identified the opportunities and challenges involved in the development of mobile broadband in Latin America. In terms of opportunities, the outlook is optimistic; the potential benefits of mobile broadband are even greater than those afforded by fixed broadband, which have been identified in other chapters of this book. Access to the benefits of the Internet is likely to be democratized through the use of mobile devices.

However, progress along this path is not guaranteed. If headway is to be made in this direction, long-standing regulatory issues in Latin America will have to be addressed. Entry barriers to the sector have to be dismantled, starting with institutional barriers that lead to the design and implementation of non-transparent and inflexible policies which limit the adoption of new technologies and thus perpetuate the digital exclusion existing in the region. Mobile broadband technology offers promising opportunities for economic growth and social development throughout the region. However, the technology has no value in and of itself; it must be effectively deployed and adopted by the population. The role of the authorities is not to limit this opportunity but rather to serve as a transparent regulatory entity, to auction off spectrum, to promote social inclusion and investment, and to intervene only in cases of evident market failures.

## Bibliography

- Álvarez, C. (2008). *Derecho de las telecomunicaciones*, Miguel Ángel Porrúa, Mexico.
- Analysis Mason, DotEco and Hogan & Hartson (2009). “Exploiting the digital dividend – a European Approach” Available online at: [http://www.analysismason.com/ec\\_digital\\_dividend\\_study](http://www.analysismason.com/ec_digital_dividend_study)
- Barrantes, R. (2007). “Convergencia Tecnológica y Armonización Regulatoria en América Latina: Evolución Reciente y Tendencias: El caso de Perú.” CEPAL – DIRSI, 2007.

- Buttkereit, S., Enriquez, L., Grijpink, F., Moraje, S., Torfs, W., and T. Vaheri-Delmulle (2009). "Mobile Broadband for the Masses: Regulatory Levers to Make it Happen." McKinsey & Company.
- Cabello, S. (2010) "Gestión del espectro: demanda y debate sobre sus usos alternativos" Ponencia presentada en Acorn Redecom 2010. Brazilia, Brazil. Available online at [www.dirsi.net](http://www.dirsi.net).
- DIRSI (2007) "Oportunidades móviles: pobreza y telefonía móvil en América Latina y el Caribe". Available online at: <http://dirsi.net/node/92>.
- Friedrich, R., Ward, J., Singh, M. and A. Lesser (2007). "The Mobile Broadband Opportunity in Emerging markets" Booz Allen Hamilton. Available online at [www.boozallen.com](http://www.boozallen.com)
- Galperin, H. y C. Ruzzier (2010). "Las tarifas de banda ancha en América Latina y el Caribe: Benchmarking y análisis" CEPAL-DIRSI, 2010.
- Galperin, H. (2007). "Convergencia Tecnológica y Armonización Regulatoria en América Latina: Evolución Reciente y Tendencias: El caso de Argentina." CEPAL – DIRSI, 2007.
- GSMA (2009). "Digital dividend for Mobile: Bringing broadband for all" GSMA. Available at: [http://www.gsmworld.com/documents/dd\\_spectrumoverview.pdf](http://www.gsmworld.com/documents/dd_spectrumoverview.pdf)
- Hazzlet, T. y Muñoz, R. (2005). "A Welfare Analysis of Spectrum Allocation Policies" George Mason, Law and Economics Research Paper N° 6- 28 ...
- Hazlett, T., Ibarguen, G. and W. Leighton (2006). "Property Rights to Radio Spectrum in Guatemala and El Salvador: An Experiment in Liberalization" *George Mason Law & Economics Research Paper* No. 06-07. Available at: <http://www.law.gmu.edu/faculty/papers/docs/06-07.pdf>
- Hirsch, C. (2010). "Oportunidades y riesgos en la migración a interconexiones IP" Unpublished.
- International Telecommunications Union (ITU) (1995). "Interconnection Regulation Self-Learning Materials", BDT/Regulatory Reform Unit, 2003.
- Katz, R.; Flores-Roux, E.; Mariscal, J. (2010). "The impact of taxation on the development of the Mobile broadband sector", GSMA and Telecom Advisory Services LCC.
- Koutrompis, P. (2009). "The Economic Impact of Broadband on Growth: A simultaneous approach", *Telecommunications Policy*, Volume 33, Issue 9, October 2009, Pages 471-485.
- Mariscal, J. (2007). "Convergencia Tecnológica y Armonización Regulatoria en América Latina: Evolución Reciente y Tendencias: El caso de México." CEPAL – DIRSI, 2007.
- Mariscal, J., Ramírez, F. y Aldama, A. (2008). "Competencias en las Telecomunicaciones de México" Mimeo.
- Muñoz, J. (2009). "Estimando el valor social de reasignar la banda de los 700MHz en Latinoamérica" Ponencia presentada en la XII Cumbre de Regulatel – Ahciet. Medellín, Colombia.
- Nicolai, C. (2007). "Convergencia Tecnológica y Armonización Regulatoria en América Latina: Evolución Reciente y Tendencias: El caso de Brazil" CEPAL – DIRSI, 2007.
- Qiang, C., Khalil, M., Dongier, P. (2009). "Information and Communication for Development" The World Bank, Washington, D.C.
- Samarajiva, R. (2009). "How the developing world may participate in the global Internet. Economy: Innovation driven by competition" Report for Joint Workshop on "Policy coherence in the application of information and communication



- technologies for development” organized by the Organization for Economic Cooperation and Development (OECD) and the Information for Development Program (infoDev), World Bank, 10-11 September 2009, Paris, France.
- Spectrum and Value Partners (2008). “Getting the most out of the digital dividend. Allocating UHF spectrum to maximise the benefits for European society”
- Unión Europea (2010). “Hacia una utilización óptima del dividendo digital” UE. Available at [http://europa.eu/legislation\\_summaries/information\\_society/l24114\\_es.htm](http://europa.eu/legislation_summaries/information_society/l24114_es.htm)
- Álvarez, C. (2008). *Derecho de las telecomunicaciones*, Miguel Ángel Porrúa, Mexico.
- Analysis Mason, DotEco and Hogan & Hartson (2009). “Exploiting the digital dividend – a European Approach” Available at: [http://www.analysismason.com/ec\\_digital\\_dividend\\_study](http://www.analysismason.com/ec_digital_dividend_study)
- Barrantes, R. (2007). “Convergencia Tecnológica y Armonización Regulatoria en América Latina: Evolución Reciente y Tendencias: El caso de Perú.” CEPAL – DIRSI, 2007.
- Buttkereit, S., Enriquez, L., Grijpink, F., Moraje, S., Torfs, W., and T. Vaheri-Delmulle (2009). “Mobile Broadband for the Masses: Regulatory Levers to Make it Happen.” McKinsey & Company.
- Cabello, S. (2010) “Gestión del espectro: demanda y debate sobre sus usos alternativos” Ponencia presentada en Acorn Redecom 2010. Brazilia, Brazil. Available online en [www.dirsi.net](http://www.dirsi.net).
- DIRSI (2007) “Oportunidades móviles: pobreza y telefonía móvil en América Latina y el Caribe”. Available online at: <http://dirsi.net/node/92>.
- Friedrich, R., Ward, J., Singh, M. and A. Lesser (2007). “The Mobile Broadband Opportunity in Emerging markets” Booz Allen Hamilton. Available at [www.boozallen.com](http://www.boozallen.com)
- Galperin, H. y C. Ruzzier (2010). “Las tarifas de banda ancha en América Latina y el Caribe: Benchmarking y análisis” CEPAL-DIRSI, 2010.
- Galperin, H. (2007). “Convergencia Tecnológica y Armonización Regulatoria en América Latina: Evolución Reciente y Tendencias: El caso de Argentina.” CEPAL – DIRSI, 2007.
- GSMA (2009). “Digital dividend for Mobile: Bringing broadband for all” GSMA. Available at: [http://www.gsmworld.com/documents/dd\\_spectrumoverview.pdf](http://www.gsmworld.com/documents/dd_spectrumoverview.pdf)
- Hazzlet, T. y Muñoz, R. (2005). “A Welfare Analysis of Spectrum Allocation Policies” George Mason, Law and Economics Research Paper N° 6- 28 ...
- Hazlett, T., Ibarguen, G. and W. Leighton (2006). “Property Rights to Radio Spectrum in Guatemala and El Salvador: An Experiment in Liberalization” *George Mason Law & Economics Research Paper* No. 06-07. Available at: <http://www.law.gmu.edu/faculty/papers/docs/06-07.pdf>
- Hirsch, C. (2010). “Oportunidades y riesgos en la migración a interconexiones IP” Unpublished.
- International Telecommunications Union (ITU) (1995). “Interconnection Regulation Self-Learning Materials”, BDT/Regulatory Reform Unit, 2003.
- Katz, R.; Flores-Roux, E.; Mariscal, J. (2010). “The impact of taxation on the development of the Mobile broadband sector”, GSMA and Telecom Advisory Services LCC.
- Koutrompis, P. (2009). “The Economic Impact of Broadband on Growth: A simultaneous approach”, *Telecommunications Policy*, Volume 33, Issue 9, October 2009, Pages 471-485.

- Mariscal, J. (2007). “Convergencia Tecnológica y Armonización Regulatoria en América Latina: Evolución Reciente y Tendencias: El caso de México.” CEPAL – DIRSI, 2007.
- Mariscal, J., Ramírez, F. y Aldama, A. (2008). “Competencias en las Telecomunicaciones de México” Mimeo.
- Muñoz, J. (2009). “Estimando el valor social de reasignar la banda de los 700MHz en Latinoamérica” Ponencia presentada en la XII Cumbre de Regulatel – Ahciet. Medellín, Colombia.
- Nicolai, C. (2007). “Convergencia Tecnológica y Armonización Regulatoria en América Latina: Evolución Reciente y Tendencias: El caso de Brazil” CEPAL – DIRSI, 2007.
- Qiang, C., Khalil, M., Dongier, P. (2009). “Information and Communication for Development” The World Bank, Washington, D.C.
- Samarajiva, R. (2009). “How the developing world may participate in the global Internet. Economy: Innovation driven by competition” Report for Joint Workshop on “Policy coherence in the application of information and communication technologies for development” organized by the Organization for Economic Cooperation and Development (OECD) and the Information for Development Program (infoDev), World Bank, 10-11 September 2009, Paris, France.
- Value Partners and Spectrum (2008). “Getting the most out of the digital dividend. Allocating UHF spectrum to maximise the benefits for European society”
- European Union (2010). “Towards optimal use of the digital dividend” UE. Available at [http://europa.eu/legislation\\_summaries/information\\_society/124114\\_en.htm](http://europa.eu/legislation_summaries/information_society/124114_en.htm)

## **Database**

- INEGI (2009). “Encuesta Nacional de Ingresos Gasto de los Hogares Mexicanos” INEGI 2009.
- Internet World Stats (2010). “Internet Usage Statistics” Available at: <http://www.internetworldstats.com>
- ITU (2010). “Free statistics” Available at: <http://www.itu.int/ITU-D/ict/statistics/>
- GlobalComms (2010). “GlobalComms: All Regions” Available at: <http://www.telegeography.com>

## VII. Policies for broadband development

Roxana Barrantes Cáceres <sup>1</sup>

### A. Introduction

Policymakers have already begun to identify and quantify the benefits of broadband services, even though these services have only become available quite recently. As a result, broadband diffusion is gradually being positioned as a national goal in developed and developing countries alike. To cite only a few cases, both the United States and the United Kingdom have forged policies for the expansion of the supply and use of broadband based on the premise that it is of strategic importance for economic development and an improvement in the population's living conditions. Several Latin American countries have followed suit and have developed plans for broadband development (Brazil, for example) or are in the process of formulating one (as is the case of Peru).

The potential of broadband as a development tool (as discussed in previous chapters) can only be realized if countries design and implement specific public policies, in the same way that policies were developed to expand railway infrastructure in the nineteenth century or roads in the twentieth century. These types of policies call for action on the part of various sectors of government, above and beyond the telecommunications sector, which

---

<sup>1</sup> Aileen Agüero García, an economist with the Peruvian research institute Instituto de Estudios Peruanos and DIRSI, provided fundamental research assistance for the development of this study. The author thanks the following individuals for their assistance in gathering data for each country: Belén Albornoz, Francisco Aldama, Carlos Arcila, José Besil, Marlene Choque, Daniel Ferrés, Luis Fleitas, Hernán Galperín, Michelle Grell, Luis Gutiérrez, Márcio Iorio Aranha, Judith Mariscal, Ismenia Moreno, Patricia Peña, Pablo Ruidíaz and Edwin San Román.

traditionally has led efforts to achieve connectivity. This is because broadband development, unlike traditional telephony, facilitates multiple uses of voice and data communications, which, in turn, improve the population's well-being by expanding the available options in terms of activities and use of time. With broadband, applications for distance education, health services, e-government and e-commerce all become possible. And all of them entail the involvement of multiple sectors of government in formulating and implementing policies.

Public policies on broadband development may include goals relating to both efficiency and equality. Efficiency objectives have to do with the availability and use of broadband applications for driving economic growth and reducing transaction costs for stakeholders in the market. Equality objectives, on the other hand, relate to the need for an entire country's population to benefit from growth, with the main mechanisms for achieving these objectives being income redistribution and access to basic services. In the realm of public services, equality objectives tend to be pursued through the implementation of universalization policies.

This chapter covers broadband policies proposed or implemented by leading countries in Latin America and the Caribbean which have: (i) already issued specific proposals or are studying their implementation, (ii) have connectivity, ICT and digital inclusion policies, or (iii) include broadband as part of their universal services policies. Based on this review, several policy recommendations are presented for the region at the end of the chapter.

Broadband development in Latin America and the Caribbean needs to take a quantum leap forward in order to close the large gaps in connectivity that exist throughout the region. This need becomes all the more apparent when the region's countries are compared with the Republic of Korea, the United States or the United Kingdom. These three countries are used in this chapter as reference points because they have studied, approved and implemented specific policies for broadband development.

As seen in previous chapters, tele-density data for fixed and mobile telephony, Internet access and broadband in the region changed significantly between 2004 and 2009. In the Republic of Korea, the United States and the United Kingdom, fixed tele-density is declining, and this trend is also being seen in the region in Uruguay, Trinidad and Tobago, and Colombia. The biggest changes in mobile tele-density have been seen in Argentina, Colombia, El Salvador, Honduras, Panama and Trinidad and Tobago. But the most important observation about mobile telephony is that tele-density levels are quite similar to those observed for the Republic of Korea, the United States and the United

Kingdom. However, the gap between the region and the reference countries in terms of Internet access and broadband service subscriptions is vast: no country in Latin America and the Caribbean comes close to 10% for either one of the two services, compared with values bordering 30% in the Republic of Korea, the United States and the United Kingdom, with broadband access lagging behind Internet access.

The very definition of broadband involves a “moving target”. As technological advances allow for greater transmission capacity, which in turn enables the development of bandwidth-intensive applications (such as videos) that are in strong demand, the minimum speed that defines a service as broadband changes over time. In 1999,<sup>2</sup> the United States Federal Communications Commission (FCC) defined one of the first thresholds for this service, setting the minimum broadband access speed at 200 kbps in one or two directions (download or upload). For its part, in June 2002, the Communications Committee of the European Commission established an operational definition for the collection of data on broadband in the European Union equivalent to 144 kbps (download). In 2004, ITU recommendation I.113 defined it as a transmission capacity faster than primary rate ISDN, at 1.5 or 2.0 Mbps (ITU 2004). In turn, OECD (2006) defined it as a data transfer rate equal to or faster than 256 kbps.<sup>3</sup> By June 2008, “basic broadband” was defined as a data transmission speed higher than 768 kbps in at least one direction, with the velocity threshold for both established companies and entrants being set at 144 kbps (OECD 2009). The latest reports mention speeds of 1 Mbps or higher

Broadband development requires a significant investment in high transmission capacity networks and improvements in access networks with the capacity for speeds required by bandwidth-intensive applications, in particular education and health services. Policies providing the conditions and incentives for this investment are the responsibility of the communications and telecommunications authorities and market regulators, but they are not the only ones who bear some responsibility in this respect. As discussed in chapter 1, in a broadband ecosystem, a comprehensive approach must be taken in order to address development challenges. That is, issues of connectivity and deployment of telecommunications services must be dealt with in conjunction with issues regarding demand (appropriation and use) and the supply of content

---

<sup>2</sup> See [http://www.fcc.gov/Daily\\_Releases/Daily\\_Business/2010/db0720/FCC-10-129A1.pdf](http://www.fcc.gov/Daily_Releases/Daily_Business/2010/db0720/FCC-10-129A1.pdf). (25/08/10).

<sup>3</sup> See [http://www.OECD.org/document/46/0,3343,en\\_2649\\_34225\\_39575598\\_1\\_1\\_1\\_1,00.html](http://www.OECD.org/document/46/0,3343,en_2649_34225_39575598_1_1_1_1,00.html) (25/08/10).

and applications. Policymaking in this area must involve officials from other sectors, such as education, health, social development and energy, if convergent, sustainable policies are to be devised.

On the subject of fostering broadband use, Levin (2010) notes that a lack of familiarity and affordability concerns are the two main factors contributing to non-subscription to a broadband service. If, for example, there are people for whom the service is affordable but who have not found a reason to subscribe, there seems to be no reason from a policy standpoint to foster the development of an activity that does not generate benefits. On the other hand, for people who do not consider the service to be affordable, but who do feel that it holds value for them, actions or policies would be justified. In this regard, the first thing to do is identify why some people do not regard the service as being affordable. For example, because low-income consumers primarily use mobile phones, subsidies for the purchase of mobile phones could prove to be the most attractive incentive that would best meet their needs.

In order to take advantage of the full benefits of broadband, users need to have access to some type of computer. Even though broadband service can be accessed via mobile phones, this type of access is a poor substitute because the speed is slower, the screen is much smaller and not all websites are compatible with mobile technology. In addition to paying monthly fixed broadband service fees, consumers incur costs related to the use of devices and auxiliary software. For these reasons, a universal broadband access programme would have to subsidize the monthly service costs and the cost of computer assistance, which could be controversial, unless it is positioned clearly within the realm of social inclusion objectives.

The overview of policies presented below is based on the model of the broadband ecosystem presented in chapter 1 of this book. The next section presents broadband development policies proposed by the Republic of Korea, the United States and the United Kingdom, which serve as a benchmark for the examination of policies in the region. In the third section of this chapter, the policies proposed in different countries of the region are discussed. The final section presents conclusions and recommendations.

## **B. Lessons from international experiences**

The countries of Latin America and the Caribbean have much to learn from the experiences of the countries that are leading the deployment of telecommunications services and that have prioritized broadband development.

These countries have designed and implemented public policies to achieve ambitious goals in relation to the supply and demand of services based on broadband applications. In order to provide an overview of the main policies for the development of broadband, three countries have been selected: the Republic of Korea, the United States and the United Kingdom. These countries were chosen because of the importance that they accord to broadband policies in their overall national policy framework, the time that has elapsed since they began to implement such policies and their economic importance or their leadership in telecommunications innovations. The European Union and the bloc of countries of the Organisation for Economic Co-operation and Development (OECD) are also included. After presenting the main elements of the plans, an analysis of the corresponding policies will be undertaken which will cover the elements that make up the broadband ecosystem infrastructure, services, equipment, content, advanced applications, and ownership and use.

### **1. Republic of Korea**

The Republic of Korea is often taken as an example because of its extensive broadband development efforts (Atkinson, Correa and Hedlund, 2008). The government established a national policy to promote ICT development in public and private sectors within the Framework Act on Informatization Promotion in 1987. This law created the National Information Society Agency (NIA) to oversee the construction of high-speed networks, the use of information technologies in government agencies, and programmes to promote public access to broadband and digital literacy. NIA established the Korean Information Infrastructure (KII) initiative in 1994 to build a national fibre optics network. It also created joint public-private initiatives that combine government loans and private-sector contributions for different programmes, including Cyber Korea 21 in 1999 (to foster e-commerce and digital literacy), e-Korea Vision 2006 in 2002, IT Korea Vision 2007 in 2003, the Broadband Convergence Network (BcN) and Enterprise IT 839 (for infrastructure development up to 2010). Under these programmes, in addition to the investment of a considerable amount of government funding, development regulations were enacted and incentives were given to private companies to build competition-based networks as a means of expanding the existing infrastructure. Efforts to encourage broadband demand and promote digital literacy were also successful.

In addition to NIA, the government has established several other agencies to promote broadband access in the public and private sectors alike. One example is the Korean Agency for Digital Opportunity (KADO), which was created

to provide all citizens, including homemakers, the elderly and persons with disabilities, with access to the Internet through specific and focused programmes. To address the issue of demand, the Korean Information Security Agency (KISA) and the Korean Internet Safety Commission (KISC) were created to monitor Internet security and ensure consumer protection, and the National Internet Development Agency (NIDA) was established to promote Internet use through education and promotional programmes, with an outstanding example of the latter being the 1996 “PC for Everyone” programme.

KII was implemented in three sectors --KII-Government, KII-Private and KII-Testbed-- in three stages. During the first phase, US\$ 24 billion was spent to build a high-speed public backbone nationwide so that service providers could deploy broadband services to approximately 30,000 government and research institutions as well as almost 10,000 schools. KII-Private focused on promoting private financing to build an access network for homes and businesses in order to stimulate the deployment of broadband in the last mile. Finally, to encourage broadband demand, the government gave small and medium-sized businesses a tax break equal to 5% of their total investment in systems for broadband communications. BeN and IT 839 also provided subsidies whereby broadband service providers were given incentives amounting to something on the order of US\$ 70 billion in low-cost loans to build high-speed broadband networks, subject to the condition that service providers had to match the government’s investment.

## **2. United States**

In March 2010, following a long consultation process that involved all stakeholders, including civil society, the United States Federal Communications Commission (FCC) published a national broadband plan called Connecting America. This plan is designed to fulfil a congressional mandate to ensure that every citizen has access to broadband. It states that the government should design policies to: ensure competition and maximize consumer well-being, innovation and investment; ensure the efficient allocation and management of assets controlled by government, such as spectrum and rights-of-way to encourage improvements in the network and competitive entry; reform existing universal service mechanisms for the development of broadband and voice services in high-cost areas; and ensure that broadband is affordable for low-income citizens. In addition, it should encourage broadband adoption and use and the modification of laws, policies, standards and incentives in order to maximize broadband benefits in sectors where government influence is significant, such as public education, health and government operations.



This comprehensive plan seeks to increase connectivity in schools and libraries, as well as to develop applications for health services that will curb rising costs. The plan consists of three phases, each of which involves the allocation of the necessary funds.

### **3. United Kingdom**

The Office of Communications (OFCOM) has been working to boost investment and competition in the broadband market since 2006. Its regulatory approach is designed to ensure that consumers, citizens, businesses and the overall economy benefit from timely investments, competition and the widespread availability of broadband services. Under the premise that broadband connections make it possible to access and interact with a wide range of content and services, the plan is designed to encourage business investment in the installation of fibre optic technology. In particular, OFCOM promotes super-fast broadband, that is, broadband with speeds greater than 24 Mbps, which will facilitate access to new applications.

Since its priority is to foster competition, OFCOM focuses on facilitating operators' access to the network run by British Telecom (BT), the incumbent. It has been proposed that BT facilitate the provision of virtual wholesale unbundled local access to other operators interested in providing Internet services. It has also been proposed that BT should be asked to offer access to its ducts and posts to other network operators so that they can expand into areas where BT does not plan to deploy its fibre optic network. This approach gives BT the freedom to set prices that reflect its costs, with a sufficient margin to cover risks.<sup>4</sup>

In a country where there is virtually no access deficit, OFCOM recognizes that fibre optics will not take the place of existing access networks in the short term. All the plans for the deployment of infrastructure, investment, initiatives for fostering competition and new services notwithstanding, the impact or benefits for the elderly and the disabled is an issue that the United Kingdom has recognized as one that needs to be addressed. The OFCOM Advisory Committee for Older and Disabled People (ACOD)<sup>5</sup> has stated that, because technological applications have not been tested for these groups, it

---

<sup>4</sup> The three main factors justifying this regulatory approach are: the the small share held by BT in the retail market (at 26%, it is the smallest in Europe), a residential broadband penetration rate of 66% and a downward price trend.

<sup>5</sup> *Next Generation Services for Older and Disabled People*, OFCOM Advisory Committee on Older and Disabled People. <http://www.ofcom.org.uk/files/2010/09/ACOD-NGS.pdf>. (16/09/10).

has been studying the products and services offered by the new generation of broadband that it considers to be of particular benefit to older or disabled consumers and citizens. There are new applications that can enable older people to have a more active role in the economy and in their communities by helping them to become more independent and to live in their own homes longer. For disabled young people, the technology represents the possibility of diversity and equal access to communications media on the same footing with people without disabilities. The main services that have been identified include monitoring and remote health consultations, supervision and counselling services, safety initiatives in the home and community, telecommuting and learning programmes, among others.

#### **4. European Union**

The European Union published a general guide to broadband network deployment in 2009. In that document, broadband access is recognized as a key component to ICT development, adoption and use. The European Union believes that broadband is vital because it makes it possible to enhance the contribution of ICTs to social cohesion, growth and innovation in all sectors of the economy. Therefore, the European Commission supports the dissemination of broadband services to all citizens. It should also be noted that all member countries' wholesale broadband markets are subject to ex ante regulation

The European Union also has a portal for the exchange of good practices for the deployment of broadband.<sup>6</sup> This portal was launched in January 2008 with a planned duration of 30 months, overseen by the European Commission's Information Society and Media Directorate-General. The objectives of the European broadband portal are to encourage the exchange of best practices and sharing of experiences, to act as a central information platform, to serve as a virtual meeting point for operators and local governments, and to ensure the coordination of broadband demand in thinly populated areas.<sup>7</sup> Finally, the European Union is making an effort to forge a common policy on spectrum management within a technology-neutral framework.

---

<sup>6</sup> This portal is one of the outputs of the conference entitled *Bridging the Broadband Gap* (Brussels, 14-15 May 2007), which concluded that the support of public authorities is needed in those areas that do not have broadband access.

<sup>7</sup> In addition, the portal provides users with access to a database on broadband projects, strategies and action plans, industry providers, and European policies and regulations, among other resources.

## 5. Summary

This section will take stock of the policies implemented by the Republic of Korea, the United States and the United Kingdom relating to the broadband ecosystem, which forms part of the conceptual framework presented in the first chapter. OECD policies are included in this analysis because that organization's policy recommendations are often used as benchmarks for policies or goals in many countries in Latin America and the Caribbean. The categories covered by this analysis include infrastructure, telecommunications services, converged terminal equipment, advanced content and applications, and advanced ICT skills. In every case, users are the focal point around which these categories are defined. A detailed comparison of policies follows (see also annex VII.1).

The first issue is infrastructure. It should be noted that three of the major players –the United States, OECD and the United Kingdom-- all agree that the spectrum should be used as an effective instrument for broadband development. Their policies highlight the view that it is essential to release spectrum and to allocate additional spectrum in order to provide higher-speed services; OECD also stresses the importance of incentives in achieving efficient use.

The Republic of Korea, OECD and the United Kingdom all have policies that foster competition for infrastructure development. The Republic of Korea's IT 839 initiative, which includes infrastructure development, training and service development, is an outstanding example. For its part, OECD states that passive infrastructure should be open-access for the development of public works, in addition to any new government-financed infrastructure, which should also be open-access. In the United Kingdom, policies have been designed to encourage competition in super-fast broadband and to safeguard opportunities for promoting competition in this area.

The Republic of Korea and OECD both assign the government a role in promoting investment in infrastructure deployment. The Republic of Korea has developed a series of strategies and initiatives to build national fibre optic networks and has also worked to boost private financing through, among other measure, tax incentives. OECD has taken a similar approach and has also indicated that governments should help coordinate the design of network route maps to encourage the deployment of smaller networks and that there should be non-discriminatory access to last-mile infrastructure. In the United Kingdom, policies have been designed in an effort to minimize inefficiencies in network design and entry barriers. In addition, OFCOM considers that fixed

networks will be called upon to play an important role in providing super-fast broadband through local fibre optics development (fibre-to-the-cabinet (FTTC as opposed to fibre-to-the-home (FTTH)).

Policies in the United States and OECD address issues regarding rights-of-way. In the United States, their administration needs to be improved in order to save time and reduce costs, while, in the case of OECD, they are seen as being the highest barriers faced by operators, which are demanding that access to rights-of-way be made fair and non-discriminatory. The United Kingdom, meanwhile, addresses the question of obligations regarding duct access as a means of sustaining competition; this model allows other operators to deploy fibre in the access network using BT ducts and poles (FTTC model).

Other components of infrastructure development are included in various policy approaches. For example, in the United Kingdom, the incumbent (BT) will be required to provide other operators that are interested in expanding their network with access to its ducts and posts in places where the market leader does not plan to deploy its services; prices are to be established on the basis of BT costs, with a suitable margin for contingencies. OECD indicates that the efficiency of technological neutrality, in the light of progress towards next-generation networks, should be evaluated. Additionally, it states that the participation of municipalities in telecommunications markets should not be blocked except in the presence of market distortions; in such cases, it suggests that the participation of municipalities should be limited to the provision of dark-fibre networks under open-access rules. Finally, it is suggested that members promote international interoperability and open standards.

Under the category of telecommunications services, only the United States addresses the topic in its policy strategies, stating that every person should have access to affordable and robust broadband service and to the means and skills to subscribe if the person so chooses. Given the competitive nature of the markets in the four cases analysed here, there are no references to specific policies regarding convergent terminal equipment.

In the category of advanced applications and content, specific measures for the development of applications in education and e-government are in place in all four cases. The United States, working to ensure that the country leads the clean energy economy, introduced the concept that all citizens must be able to use broadband to control and manage their energy consumption in real time. In addition to energy and the environment, other areas being addressed include health, public safety and employment promotion. Policies in the Republic of Korea, OECD and the United Kingdom emphasize e-commerce. The United States and OECD agree on the need to ensure data privacy; the latter, in

particular, draws attention to the importance of intellectual property rights and the need to combat piracy and to promote digital content, competition and innovation, with emphasis on research and development. OECD also proposes that more complex, information-rich mobile applications should be bolstered. The organization also states that government services and content should be put online in order to promote a more efficient form of organization of the public sector and that the various initiatives in this respect require the active involvement of industry through public-private partnerships.

In terms of advanced ICT skills, the Republic of Korea and the United States both have digital literacy programmes. According to OECD policy statements, differences in income, gender, education, and other factors influence the adoption and use of broadband, thus giving rise to so-called “new gaps in use”. In order to bridge these gaps, countries must promote suitable training programmes.

Finally, on the issue of users, the Republic of Korea, the United States and OECD all seek to ensure that broadband will be affordable for low-income residents. The United States, in particular, is working to develop mechanisms that will give consumers the information they need in order to choose the best offer on the market. The Connect America Fund was created to finance affordable voice and broadband services with a download speed of at least 4 Mbps, and the Mobility Fund was established to provide financing to ensure that no state lags behind in 3G wireless coverage.

Finally, ways to broaden the contribution base of the United States Universal Service Fund will be sought in order to ensure that at least 100 million households have affordable access to real download speeds of at least 100 Mbps and at least 50 Mbps upload.

### **C. Broadband development policies in Latin America and the Caribbean**

Policy design and implementation for the development of broadband is a fairly new topic in the region. This section starts by distinguishing between connectivity or ICT development policies and those policies targeting broadband development. Policies focusing on connectivity and ICT development can be classified as first-generation policies, while the policies on broadband development address different aspects of the broadband ecosystem model. The latter type of policy takes into account not only connectivity, but also the use and appropriation of the service, as well as the need to broaden the supply of broadband-based applications and to reduce the transaction costs

incurred by the State or the private sector when providing these public services. Based on this distinction, table VII.1 identifies the countries that already have broadband plans, those that have other types of plans to address the subject, those that are examining the issue and those in which this issue has not yet been included on the policy agenda.

Table VII.1  
Types of broadband policies in Latin America and the Caribbean

Country	Broadband plan in effect	Broadband included in plans, agendas or projects	Under analysis	Subject not yet addressed
Argentina		X		
Bolivia (Plurinational State of)			X	
Brazil	X			
Chile		X		
Colombia		X		
Costa Rica		X		
Cuba		X		
Dominican Republic	X			
Ecuador		X		
El Salvador				X
Guatemala		X		
Honduras				
Mexico		X		
Nicaragua		X		
Panama		X		
Paraguay		X		
Peru		X	X	
Trinidad and Tobago	X		X	
Uruguay		X		
Venezuela (Bol. Rep. of)		X		

Source: Prepared by the authors based on information collected from each country.

Note: For a more detailed presentation of the information for each country used to construct this table, see annex VII.2.

## 1. Countries with broadband development policies

Only three countries in the region have broadband development plans in place: Brazil, the Dominican Republic, and Trinidad and Tobago (although, strictly speaking, only Brazil's plan is in the public domain and has been approved at the highest policy level). In the Dominican Republic, there is no official plan for broadband, but there is a project in its final stages of implementation that is bringing residential telephone and broadband services to 506 towns in every district in the country. In Trinidad and Tobago, in May 2007 the government approved a strategy for the development and deployment of broadband services and facilities, but that strategy had not yet been published at the time of writing.

### **(a) Brazil**

Brazil has been working to encourage the deployment of the necessary infrastructure for the operation of broadband. The country has assigned an important role to spectrum allocation and is reviewing its management and seeking to make its use more efficient in order to expand the supply of broadband services, including 3G technologies. This approach is in line with the policies proposed by the United States, OECD and the United Kingdom, where the importance of efficient management of the spectrum is also being stressed.

The country plans to frame production and technological policies to promote the construction of broadband networks through a wide range of mechanisms, including the expansion of credit for micro-lending initiatives, funding for digital city projects, tax breaks for broadband access services and nationally produced equipment, and the use of the Technology Development Fund (FUNTEC). It also plans to implement a national broadband network focused on the resale of network capacity to private operators. Similar initiatives, in which private financing has been stimulated through tax and other incentives, have been undertaken in the Republic of Korea in order to build a nationwide fibre optic network.

Another objective is to ensure the deployment of a broadband backbone network in every municipality in the country. These networks will be administered by Telebrás. In municipalities where there is no competition in service provision in the last mile, the government will take special measures to ensure that the end consumer will benefit from lower prices. This contrasts with the approach taken in the United Kingdom, where the focus is on developing local fibre (fibre-to-the-cabinet (FTTC)) instead of fibre-to-the-home (FTTH). This is mainly because, unlike the situation in Brazil, there is virtually no access deficit in the United Kingdom.

With regard to the issue of advanced applications and content, there are policy proposals concerning public broadband Internet connections in universities, research centres, schools (broadband access in 55,000 public schools, including the donation of the ADSL modem), hospitals, health centres, community tele-centres and other public meeting places. The main tool for fostering the use of ICTs will be the government's support for the popularization of broadband access, digital inclusion efforts and the expansion of e-government services. In the area of skills, Brazil intends to train the entire population in ICT use. All these policies are similar to those being pursued by the Republic of Korea, the United States, OECD and the United Kingdom. The goals of the Brazilian programme are outlined in table VII.2.

Table VII.2  
**Short-, medium- and long-term goals set by the national broadband programme in Brazil**

Term	Goals
Short term (2010)	<ul style="list-style-type: none"> <li>• Implement a fibre optics network in 16 major cities</li> <li>• Launch the federal government's intranet and establish connections with 96 corporate sites (capacity 1 Gbps)</li> <li>• Implement a backhaul network in 100 municipalities</li> </ul>
Medium term (2011)	<ul style="list-style-type: none"> <li>• Implement a fibre optics network in eight major cities</li> <li>• Launch the federal government's intranet and establish connections with 48 corporate sites (capacity 1 Gbps)</li> <li>• Disseminate broadband: greater supply, lower prices and higher capacity</li> <li>• Integrate public policy issues in education, health, culture and other areas</li> <li>• Integrate cities that rank low on the Human Development Index</li> </ul>
Long term (2013)	<ul style="list-style-type: none"> <li>• Implement a fibre optic network in three capital cities</li> <li>• Launch the federal government's intranet and establish connections with 18 corporate sites (capacity 1 Gbps)</li> <li>• Integrate the educational, health, cultural and others sites identified in public policy statements</li> <li>• Integrate cities with that rank low on the Human Development Index and digital cities</li> </ul>

Source: Brazil Connected, the national broadband programme, available at: <http://www4.planalto.gov.br/brasilconectado/forum-brasil-conectado/documentos/3o-fbc/documento-base-do-programa-nacional-de-banda-larga> (07/12/10).

Projections prepared by the national telecommunications regulatory agency in Brazil (Agência Nacional de Telecomunicações (ANATEL)) indicate that in 2011 the number of broadband connections will outstrip fixed ones. By 2018, approximately 160 million connections are expected to be in place, of which 40 million will be fixed access and the rest will be mobile (see figure VII.1).

Figure VII.1  
**ANATEL projections for broadband connections in Brazil**

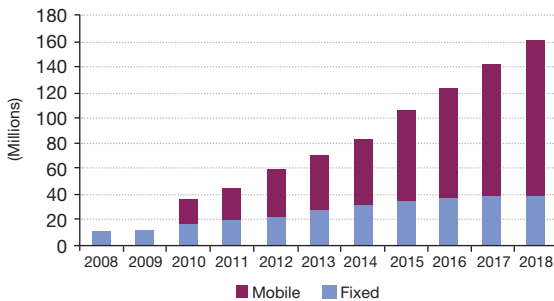

Source: Adapted from *Um plano nacional para banda larga o Brasil em alta velocidade* (A national plan for high-speed broadband in Brazil), <http://www.mc.gov.br/images/pnbl/o-brasil-em-alta-velocidade1.pdf>.

**(b) Dominican Republic**

The Dominican Republic’s plan promotes the installation of infrastructure to meet the needs of broadband Internet access and the full range of services that can be provided over broadband. In the area of telecommunications, it seeks to promote basic residential telephone services in underserved



communities and in areas where the Dominican telecommunications regulatory agency (INDOTEL) has been involved with social inclusion projects.

In terms of skills, the policy provides for the establishment of digital community centres and distance and classroom training courses that can be attended by people regardless of their geographic location, economic status, gender, age and physical ability. It also provides for computer training centres and community technology centres and for the provision of training for the general public in advanced ICT skills.

## **2. Countries that are formulating broadband development plans**

In March 2010, a multisector commission was created in order to develop a national plan for broadband development in Peru. As part of its activities, the commission prepared an assessment of the status of infrastructure, the market for fixed and mobile telephony services, cable television and broadband Internet, fees, access terminals, the legal framework for the regulation of the Internet, and the country's position within an international context.

As noted in previous chapters, Peru's indicators place the country at the tail end in terms of the development of services in the region. The explanation for this lag, according to the commission's studies, lies in a number of different constraints. First, the commission's report points to barriers to the deployment of transport networks. For example, there is a high concentration of transport networks or fibre optic backbones along the coast, while the mountainous and jungle regions have little, if any, infrastructure. There are also legal limitations with respect to the sharing of other sectors' infrastructure for the development of telecommunications services, specifically in relation to the implementation of mandatory infrastructure-sharing arrangements under Supreme Decree No. 024-2007-MTC, which is intended to promote efficiency in State investment in highways to promote the deployment of telecommunications infrastructure. Additionally, there are disincentives for the deployment of fibre optics using the national highway network's rights-of-way.

Barriers to the development of access networks also exist at the municipal, district and provincial levels. Not enough of the radio spectrum is available to support the development of mobile broadband. Here again, there are legal barriers, with the main constraints stemming from the regulatory framework for the preservation of the national heritage that is overseen by the National Institute of Culture, which places extra restrictions, in addition to those contained in the national building code, on the installation of towers and air networks.

Barriers to broadband Internet access and, more specifically, to the laying of fibre optics in rural or disadvantaged areas are rooted in laws governing the Telecommunications Investment Fund (FITEF) and the rural telecommunication projects that it implements. Cost overruns occasioned by excessive regulation (i.e., service quality requirements similar to those applying in urban areas) represent another type of barrier.

Three barriers to competition in broadband Internet access services were also identified: regulations on access to transport networks; a lack of policy controls on mergers and acquisitions in the telecommunications market; and the absence of inter-platform competition or effective retail competition.

Finally, other factors that restrict user access to broadband services include budget constraints on the acquisition of access equipment, the low density of terminals for broadband use, and piracy or illegal use by users and operators.

Following a lengthy consultation process, the commission shared its vision, goals and policy recommendations for the development of broadband in Peru in a document that it issued in July 2010. This report includes a recommendation concerning the use of the available resources for backbone construction which are administered by the Telecommunications Investment Fund and sets out four goals for 2016:

1. All educational centres and health-care establishments in urban areas are to have broadband connections, preferably at the highest residential speed available in the area.
2. All townships in Peru should have broadband coverage for, as a minimum, the municipality, education centres and the largest public health establishments, preferably at the highest residential speed available in the area.
3. Four million broadband connections should be in place nationwide.
4. One-half million high-speed broadband connections (above 4 Mbps) should be in place.

The factors identified as pillars for the success of the national broadband development plan include a favourable macroeconomic environment, the commitment of the players involved and an appropriate institutional framework. The proposed plan addresses three objectives: (i) to provide infrastructure and services for the development of broadband nationwide, (ii) to stimulate demand and promote the population's integration into the

information society, and (iii) to strengthen the institutional framework for ICT convergence. The recommendations concerning each of these objectives are outlined in table VII.3.

Table VII.3

**Recommendations of the multisector commission of Peru, by objective**

Infrastructure	Demand	Institutional framework
Build a fibre optic backbone nationwide.	Provide a value added tax (VAT) exemption for low-priced computers.	Modify the institutional framework for broadband deployment in order to integrate public policies and strategies.
Improve regulations regarding the sharing of infrastructure to support an efficient use of dark fibre deployed by energy licensees.	Provide health-care and educational establishments with connectivity.	Redesign indicators for measuring the development of broadband.
Facilitate the use of rights-of-way on highways.	Implement e-government.	
Eliminate municipal restrictions.	Encourage the creation and development of digital applications and content.	
Streamline the procedure for suspending service due to improper use.	Form alliances among the State, NGOs and the private sector to develop digital content and applications.	
Modify regulations so that service can be supplied to rural areas.	Propose a national training programme in ICT skills.	
Facilitate the installation of networks by modifying the national building code.		
Review spectrum issues.		
Encourage competition.		

Source: Prepared by the authors on the basis of official data.

Additionally, it is important to remember that Peru's universalization policies and broadband policies are linked. The projects being carried out by FITEC include targets for Internet access.<sup>8</sup> FITEC has also recently been instructed to develop Internet projects and rural broadband.

### 3. Countries with ICT development or connectivity plans

Unlike countries with explicit plans for broadband, countries that have connectivity or ICT development plans have a different set of objectives or policies. In most of these countries, the development of broadband is mentioned in various plans, agendas, laws or projects focusing on the creation of universal access or service funds.

In Argentina, the digital agenda does not include any specific plans for popularizing Internet services, nor does it have service penetration targets; it simply states that it is necessary to ensure connectivity nationwide using universal

<sup>8</sup> Examples of such projects include a rural broadband project in San Gabán–Puerto Maldonado, a broadband project to support the development of the region of Valle de los Ríos Apurímac y Ene, a broadband service delivery project for rural areas and a public investment project aimed at achieving universal telecommunications coverage in Peru.

service delivery as one of the key means of achieving the inclusion of excluded communities. The country does, however, have a programme for the provision of local, national and international long-distance telephone services and value-added services (Internet access) in towns of over 250 inhabitants that currently lack basic telephone service coverage. The minimum speed for Internet connections is 128 kbps, and the service fee is to be similar to the rates charged in five major urban centres in the country. The programme will be implemented with funding from the Universal Service Trust Fund (FFSU), and telecommunications service licensees are pre-qualified to submit project proposals.

In the Plurinational State of Bolivia, no specific development targets for broadband are not mentioned in the Constitution or the National Development Plan. The National Digital Inclusion Plan sets forth the following objective: “To improve connectivity access (Internet) through the provision of better-quality services at reasonable prices and to extend coverage to areas where today there is none.” The Plan expands upon this objective by stating that it seeks to: “integrate the most needy into the knowledge society through access, use and development of telecommunications, Internet, content and services in order to reduce the digital divide.” The available information to date is still vague, but once the National Digital Inclusion Plan, the National Telecommunications Plan and the National ICT Programme are officially approved, a clearer picture of the type of policies that are being proposed is likely to emerge.

Chile is currently implementing its Digital Strategy 2007-2012. One of the plan’s goals is to double the number of broadband connections and to provide coverage for the entire country by 2012. In addition, its fourth goal is to: “increase the intensiveness and depth of ICT use by students and civil society.” The plan goes on to specify the following: “People are to have connectivity and access to ICTs in carrying out their various activities; the country is to have a range of services and public and private content available on the network that are relevant and appropriate to educational needs; and the country is to have a solid network of public libraries, service centres and other community access points to promote the digital inclusion of low-income sectors.”

The new Administration that took office in March 2010 also has a digital/telecommunications programme aimed at addressing universal access and broadband issues.<sup>9</sup> The overall objective of this programme is to achieve

---

<sup>9</sup> It is also important to point out that, in July 2010, the Chilean government, through the Under-Secretariat of Telecommunications, publicly declared its interest in coordinating multilateral efforts within the context of a work plan to reduce the cost of international broadband links throughout South America.

a level of broadband penetration similar to the average observed in OECD countries. Its specific objectives include the following:

- Increase the percentage of household broadband connections from 40% to 70% in order to attain the average connectivity rate of OECD member countries (22%)
- Connect 100% of the nation's schools to high-speed Internet
- Increase the connectivity rate for the population from 10% to over 22%
- Connect 100% of Chilean companies.

The second general objective in Chile is to improve the market through greater competition and better service quality. Specific objectives include:

- Support fixed and mobile number portability
- Pass legislation to support network neutrality and guarantee a minimum bandwidth
- Drive competition based on service quality
- Create a telecommunications superintendency.<sup>10</sup>

In Colombia, ICT Act No. 1341 does not specifically target the development of broadband. Article 69, paragraph 2, is the only provision that makes reference to the topic: "The Ministry of Information Technology and Communications will promote projects to provide mass access to broadband in income strata 1 and 2 on TPBCL and TPBCLE networks through the Information Technology and Communications Fund (during the transition period referenced in this article)."<sup>11</sup>

Earlier, however, the National Council for Economic and Social Policy (CONPES) set up projects to promote broadband connectivity for public institutions, community tele-centres and regional competitiveness through the replacement and expansion of networks to provide broadband telecommunications services within the framework of a universal access policy.

In Costa Rica, the development of broadband is included in the National Plan for Telecommunications Development, 2009-2014. This plan sets out the

---

<sup>10</sup> Information and post shared and published on the blog of Alejandro Barros <http://www.alejandrobarrros.com/content/view/901047/Politica-de-Telecomunicaciones-2010-2014.html#content-top> concerning the presentation made by the Under-Secretariat of Telecommunications (SUBTEL) in a panel of the Working Group on Telecommunications of the organization Fundación País Digital ([www.paisdigital.org](http://www.paisdigital.org)) (7 August 2010).

<sup>11</sup> *Public Switched Telephone Network (PSTN); Extended Public Switched Telephone Network (EPSTN).*

following goals: (i) ensure that all end-users will have access to broadband Internet, including wireless technologies in the communities where the cost of installation and maintenance of infrastructure is high in the medium term; (ii) establish broadband Internet access centres in less developed rural and urban communities, particularly in shelters for children, the elderly, disabled persons and indigenous populations; (iii) provide broadband Internet access to schools participating in the computer education programme of the Ministry of Public Education; (iv) provide broadband Internet access to hospitals, clinics and other community health centres of the Costa Rican Social Security Fund; and (v) provide broadband Internet access to public institutions in order to simplify and streamline their operations and services and to increase transparency and citizen participation.

In addition, one of the guidelines for this plan states that “immediate action should be taken to ensure access to broadband Internet for all sectors of the population, starting at 512 kbps for those populations living in economically and socially vulnerable areas and moving on to 4 Mbps for commercial use, and to a symmetric super-broadband (20 Mbps) and a symmetric ultra-broadband (100 Mbps) for the production sectors that require more bandwidth.”

In Guatemala, the Telecommunications Development Fund (FONDETEL) is the financial mechanism that has been put in place to promote the development of telephony services in rural and low-income urban areas. Its objective has evolved towards Internet connectivity, which is seen as a basic element for the development of other programmes and projects to provide access, applications and content. While there is no formal plan for broadband development, subcomponent 1.4 of the Rural Economic Development Programme (PDER), which is financed by a loan from the World Bank, includes the following specific targets: (i) provision of broadband Internet access to 100% of the municipalities in the eight departments within the PDER service area, (ii) access to a telephone within a radius of no more than five kilometres for 100% of rural communities with populations of over 400 people, and (iii) coverage of 90% of the demand for training in Internet skills.

Mexico has enacted a law to promote the development of the information society and establish its agenda for connectivity. The agenda states that the country should “ensure universal broadband access throughout the government and communities nationwide, especially in schools and other educational spaces, libraries, health centres, government offices at the three levels of government, and throughout the network of community access points located in poor and geographically remote locations.”

This implies that universal access to broadband is one of the paramount objectives of Mexico’s connectivity agenda. The agenda also includes a target

for increasing broadband coverage to 22 users per 100 inhabitants (60 million Internet users nationwide). This is to be achieved through the use of a fibre optic backbone and supplementary State-run wireless networks.

Panama is seeking to promote equal opportunities for all citizens through its universal Internet access project (National Internet Network). Thanks to this project, the country has more than 651 WiFi hotspots offering free Internet access in 22 cities. In addition, Act No. 59/2008 promotes public telephony, Internet access and other services to meet the needs of the population in disadvantaged areas.

As part of the strategy for achieving universal access being implemented by Paraguay's National Telecommunications Commission (CONATEL), the "Paraguay Connected 2013" programme is aimed at providing telephony and Internet access to all municipalities nationwide.

Uruguay is a case apart since, although it has no specific plan for broadband development, it has the highest level of access in the region. Some of the contributing factors are the extensive coverage of the National Telecommunications Administration (ANTEL), whose infrastructure includes fibre optics, copper wire and cable modem, and the accessibility targets of the country's telecommunications rate structure. In addition, as of 2010, broadband access will be increased through the extension of the Ceibal plan. This plan's original objective was to give elementary school students in the public school system access to laptops. The extension of the plan provides for actions and policies to connect 380,000 computers to the Internet for students in the public system up through high school.

Finally, in the Bolivarian Republic of Venezuela, there is no legal instrument or specific development plan on broadband development and access. Mass access to the Internet is guaranteed by Presidential Decree No. 825 of 2000, which declares Internet access and use to be a priority policy for cultural, economic, social and political development.

#### **D. Conclusions and recommendations**

If the full potential of broadband is to be attained, a set of policies must be designed and implemented to encourage and facilitate its deployment, taking into consideration all aspects that make up the broadband ecosystem. This means that provision must be made for its appropriation and use—specifically, skills development for different types of users—as well as the development of content and functionality with advanced applications, rather than simply

connectivity and the variety of services and technologies that high-speed Internet access can support.

This chapter has differentiated broadband development policies from policies aimed at digital inclusion, connectivity and ICT development in Latin America and the Caribbean. While the former focus on broadband development as an ecosystem, the latter include only some of the various components, and are not necessarily implemented in a holistic or coordinated manner across the relevant sectors of the civil service.

An analysis of the situation points up the scale of the efforts made or proposed by leading stakeholders, such as the Republic of Korea, the United States, the United Kingdom and OECD. In all of these cases, different actors (private sector, public sector and users) have been involved and have approached the issues relating to this ecosystem from different standpoints, which have included the development of user skills and the implementation of connectivity in key public areas such as public schools and libraries. Along these lines, the *first policy recommendation* is that countries should formulate broadband development plans and accord them the status of a State policy, thereby laying the groundwork for inter-sector coordination within government and between government and the private sector. This type of coordination is necessary for policy implementation and for policy continuity over time, which should extend beyond the terms of any given Administration.

The Republic of Korea, for example, extended loans to small businesses and provided training for housewives as part of various programmes designed and implemented as early as 1994. The United States and United Kingdom have prioritized the need to balance policies that encourage private investment with policies that promote competition and give consumers the chance to choose among different providers. The United States has proposed a programme consisting of three different stages, each of which is to have earmarked funding. The plan emphasizes the need to connect public schools and libraries and to develop health applications. It also underscores the importance of service affordability and of building user skills and ownership. In all cases, the goals for access speeds are ambitious.

Brazil has taken the lead in the region by enacting a comprehensive plan for broadband development whose components are similar to those of the plan to be put in place by the United States, although it differs in some ways to take into account the lack of connectivity in Brazil. The plan is quite ambitious: the first 100 municipalities are to have broadband connections by late 2010, with all municipalities nationwide connected by the end of 2014. The long-



term goal is to reach 4,278 cities. The increase in the number of broadband connections is projected at approximately 160 million by 2018, with one quarter of this number being fixed lines and the rest mobile connections. The resources needed to make this planned expansion a reality are to come largely from the public sector. Peru has set more modest goals than Brazil has in the broadband development plan it is currently formulating, and access speeds are to depend on the facilities available in each municipality. The plan projects an increase of half a million connections at speeds of 4 Mbps or more by 2016. Furthermore, it proposes that part of the resources in the Telecommunications Investment Fund (FITEL) be used to finance the construction of backbone networks where none exist. Based on these experiences, the *second recommendation* is for countries to set ambitious but realistic goals in terms of the public effort involved.

Other countries have different types of plans, some of which are aimed at using broadband to achieve connectivity nationwide or for specified activities in such areas as education and health. In some cases, they also have digital inclusion policies, which, in turn, are tied in with policies for universalizing telecommunications services through the use of access or universal service funds or loans from multilateral organizations.

The countries in the region with a major deficit in terms of infrastructure and connectivity have the opportunity to take a qualitative leap forward by installing fibre optic networks that allow higher transmission speeds, particularly in areas that have traditionally been bypassed. The only way to achieve that goal is to use the resources in the various universal service or access funds either to build backbone networks or to extend these networks to provincial capitals and municipalities and ensure the provision of broadband services in public facilities such as schools, medical centres or libraries. The United States, for example, plans to increase financing for universal service by setting up funds at each stage of the plan's implementation. Canada represents another interesting case; it is taxing a wide range of telecommunications and related services in ways that result in a fairly low rate and are less costly for operators; this approach is considered to be more efficient because it introduces fewer price distortions (Alleman et al., 2010). These examples suggest that it would be advisable for the Latin American countries to evaluate the mechanisms that they have for the establishment of universal access funds.

Consequently, a *third recommendation* is that countries should mobilize public resources to address development-related activities within the broadband ecosystem that are not being undertaken by private enterprises. Resources could be allocated from a country's national budget or funnelled through funds established to promote connectivity, competitiveness or the universalization of

telecommunications services. Accessible training programmes for homemakers, disabled persons and the poor that will enable them to develop the necessary skills to use these services will be a particularly important component of public-sector efforts.

If government funds are used to build the necessary infrastructure, then it will be important to bear in mind the OECD recommendation concerning the need to ensure that access is open and, more specifically, non-discriminatory. Along these lines, a *fourth recommendation* is that countries should strive to balance the demands of infrastructure development and the promotion of private investment with the need to encourage competition and innovation. Regulators must make a commitment to design effective mechanisms to ensure open access to high-capacity networks and the efficient use of spectrum in order to take advantage of technological changes in order to offer a range of functions through mobile telephony.

## Annex VII.1

## Policies in the Republic of Korea, the United States, the OECD and the United Kingdom, by components of the broadband ecosystem

Policies	Republic of Korea	United States	OECD	United Kingdom
Infrastructure (convergent networks)		<p>Expand the opportunities for innovative spectrum access models.</p> <p>Create mechanisms and incentives for the reuse of spectrum. Free up and allocate additional spectrum.</p> <p>Update rules for wireless backhaul spectrum.</p>	<p>As access to spectrum still constitutes a significant barrier to the provision of wireless broadband, market mechanisms to encourage its efficient use should be promoted.</p>	<p>Spectrum should be freed up so that new technologies can be introduced and consumers can be provided with higher speed services.</p>
	<p>The "IT 839" Initiative, formulated in 2004, for infrastructure development to 2010:</p> <ol style="list-style-type: none"> <li>1. Introduce and promote eight services, including: residential Internet service, ICTs, W-CDMA (Wideband Code Division Multiple Access) services, telephony via Internet, etc.</li> <li>2. Construction of infrastructure.</li> <li>3. Development of nine IT new growth engines, including digital TV, new generation PCs, ICTs and new generation mobile communications, among others.</li> </ol>		<p>Any new infrastructure built with government funds should be open-access in order to ensure that access to the network is non-discriminatory.</p> <p>Installation of open-access must be promoted when developing public works.</p>	<p>Competition terms of in super-fast broadband infrastructure should be stimulated in order to attract more investment and to drive innovation and differentiation.</p> <p>Providing fair opportunities for companies to synchronize their investments with the deployment of BT will safeguard the continuity of opportunities to promote competition based on physical infrastructure.</p>
	<p>The National Information Society Agency (NIA) oversees the construction of high-speed networks.</p> <p>NIA established the Korean Information Infrastructure Initiative (KII) in 1994 to build a national network of fibre optics.</p> <p>KII-Private focused on promoting private financing to build an access network for households and businesses with the objective of stimulating broadband deployment in the last mile.</p>	<p>Facilitating the efficient construction of new infrastructure.</p> <p>The United States must lead the world in mobile innovation with a faster and more extensive wireless network than any other country.</p>	<p>Governments should promote strong investment in infrastructure.</p> <p>Governments should help to coordinate the design of network route maps to encourage the deployment of smaller networks requiring interconnections.</p> <p>Regulators must consider new and different policies to assure fair and non-discriminatory access to last-mile infrastructure (e.g., operators can share the internal wiring in buildings).</p>	<p>Minimizing network design inefficiencies and entry barriers.</p> <p>Fixed networks are to play an important role in providing super-fast broadband.</p> <p>Promoting network designs that take into account potential future competition.</p> <p>Focusing on the development of local fibre (fibre-to-the-cabinet) rather than on fibre-to-the-home.</p>

Policies	Republic of Korea	United States	OECD	United Kingdom
	<p>In order to stimulate broadband demand, the government has given small and medium-sized businesses a tax exemption equal to 5% of their total investment in broadband communications systems. This pattern of incentives (tax subsidies and loans) was also used in BcN and the IT 839, providing broadband service providers with incentives worth around US\$ 70 billion in low-cost loans to build high-speed broadband networks, provided that suppliers committed to invest an equal amount.</p>			
		<p>Improving rights-of-way administration to save time and reduce costs.</p>	<p>Civil costs associated with the development of infrastructure (such as road construction and obtaining rights-of-way) are the greatest barriers faced by telecommunications operators. Governments should improve access to passive infrastructure and coordinate civil works as an effective way to encourage investment.</p> <p>Access to rights-of-way must be fair and non-discriminatory.</p>	<p>There is strong interest in opportunities for using BT ducts for a backhaul connection between street cabinets and other operators' networks as a means of sustaining competition in the fibre-to-the-cabinet (FTTC) scheme.</p>
				<p>Proposal to ask BT to offer access to its ducts and poles so that other network operators can expand into areas where BT does not plans to deploy its fibre optic network.</p> <p>OFCOM suggests that BT be allowed to set the wholesale price for virtual unbundled local access, while the price of access to ducts and poles should be set at a level that reflects the costs borne by BT, plus a suitable margin to cover its risks.</p>
				<p>BT will be required to provide other operators interested in supplying Internet services with access to its network through virtual unbundled local access.</p>

Policies	Republic of Korea	United States	OECD	United Kingdom
			With the move towards next-generation networks, an effort should be made to assess whether technological neutrality is an efficient policy structure.	
			Municipalities should not be barred from participating in telecommunications markets. However, if there are market distortions, it is suggested that municipal participation be limited to basic aspects, such as the provision of dark fibre networks under open access rules.	
			Governments should promote international interoperability and open standards.	
Telecom services (Internet BA)		Each citizen should have affordable and robust access to broadband service, together with the means and skills to subscribe if he or she wishes to.		
Convergent terminals/ devices	Competitive markets.	Competitive markets.	Competitive markets.	Competitive markets.
Advanced applications and content	<p>NIA promotes the use of information technologies by government agencies.</p> <p>The National Internet Development Agency (NIDA) encourages Internet use through education and promotional programmes.</p> <p>The KII-Government initiative was used to provide broadband services to approximately 30,000 government and research institutions and 10,000 schools.</p> <p>Cyber Korea 21 was started up in 1999 to promote e-commerce and digital literacy.</p>	<p>Reforming laws, policies, standards and incentives in order to maximize the benefits of broadband in sectors where government influence can be most significant, such as health, education, energy and the environment, public safety, e-government and employment promotion.</p>	<p>Some member countries have the capacity to make a greater effort to promote the deployment of broadband and its use in public institutions, businesses, homes and government.</p>	<p>OFCOM is promoting super-fast broadband (i.e., broadband with speeds higher than 24 Mbps), which will facilitate access to new applications.</p> <p>According to OFCOM, the development of super-fast broadband can increase consumer welfare through the applications that it can provide. This, in turn, will enable consumers to participate more fully in society and democracy.</p>
		<p>Clarifying the relationship between users and their online profiles to enable continued innovation in applications and to guarantee consumers' privacy.</p> <p>Providing security for citizens through a nationwide interoperable public safety broadband network.</p>	<p>Member countries should encourage broadband use by companies and its application in e-commerce. To that end, they should develop applications for this sector, taking into account existing bottlenecks and devising ways to resolve them.</p> <p>Information security must be guaranteed.</p> <p>The role of intellectual property rights must be taken into account in efforts to encourage innovation and creativity and to reduce piracy.</p>	<p>For businesses, applications in commerce are fundamental and will be promoted.</p>

Policies	Republic of Korea	United States	OECD	United Kingdom
		Every community should have affordable access to broadband service of at least 1 gigabit per second for institutions such as schools, hospitals and government offices.	The government should promote the use of mobile content in the areas of health information, education, etc. within the public sector.	
			Activities that encourage the development of digital content, competition and innovation should be promoted, with emphasis on research and development.	
			More complex, information-rich mobile applications should be promoted while taking into consideration the affordability of access to mobile broadband, the market structure, competition and the various standards.	
			Government services and content should be placed online, as e-government services and broadband applications will boost the efficiency of the public sector.	
			The development of more advanced broadband applications in such areas as telecommuting, education, energy, health and transportation should be promoted in social sectors. To this end, the active involvement of industry (public-private partnerships) is needed.	
		Ensure a leadership position for the United States in the clean energy economy. Each citizen should be able to use broadband to control and manage energy consumption in real time.		
Advanced ICT skills	NIA has set up programmes to promote public access to broadband and digital literacy.	Every citizen should have the opportunity to attain digital literacy. To this end, the Digital Literacy Corps will organize training courses for young people and adults so that they can acquire digital literacy skills.	Differences in income, gender, education, etc. are factors influencing the adoption and use of broadband in member countries (the "new use gaps"). The effects of these differences have to be understood and mitigated, and relevant ICT skills training should be promoted.	
	Cyber Korea 21 was set up in 1999 to promote digital literacy.	Programmes in conjunction with the private sector aimed at breaking down adoption barriers.		

Policies	Republic of Korea	United States	OECD	United Kingdom
Users (goals)	The Korean Agency for Digital Opportunity (KADO) was created in order to ensure that citizens (including older adults and people with disabilities) have access to the Internet through specific and focused programmes.	Ensuring that broadband is affordable for low-income citizens.	Governments must ensure that all citizens have access to very high speed broadband networks.	
		Developing mechanisms to compel operators to provide consumers with the information they need in order to be able to choose the best plan or service on the market.	In urban areas, Internet users should have the option of having wired or wireless services. In rural areas, a different competition scheme is proposed.	
		Creating the Connect America Fund as a means of providing affordable broadband and voice services with a real download speed of at least 4 Mbps.		
		Creating a mobility fund in order to ensure that no state lags behind in 3G wireless coverage.		
		Broadening the contributions base for the Universal Service Fund (USF).		
		At least 100 million households should have affordable access to download speeds of at least 100 Mbps and 50 Mbps upload.		

Source: Prepared by the authors on the basis of official information.

## Annex VII.2.

**Information about broadband policies in Latin America and the Caribbean**

*Argentina.* The Digital Agenda initiative does not include specific plans for the popularization of Internet services, nor does it set service penetration targets; it simply focuses on the need to create a national Internet network with the capacity to extend connectivity through the universal provision of service as a key tool for including marginalized communities. Additionally, under resolution 88/2009 a programme has been set up to promote telephony and Internet for towns that currently do not have basic telephone service coverage. The programme aims to provide local telephone service, international and national long-distance service and value-added services (Internet access) in towns with more than 250 inhabitants that do not yet have basic telephone services. The plan stipulates that the minimum Internet connection speed is to be 128 kbps and that the price of service should be similar to rates charged in the five major urban centres of the country. The programme will be implemented using FFSU resources, and telecommunications service licensees are eligible to submit proposals.

*Plurinational State of Bolivia.* The country does not have a broadband plan, but several plans and programmes that include broadband development (although they do not specifically refer to universal broadband access) are being developed. The National Digital Inclusion Plan, the National Telecommunications Plan and the National Programme for Information Technology and Communication are the largest of these initiatives. During the second term in office of President Evo Morales, changes in the executive branch and the cabinet have been made. According to the Director-General of Science and Technology, who responsible for developing a national digital inclusion plan, the change of ministers has interfered with the continuity of plan's development.

*Chile.* The fourth goal of the Digital Strategy for 2007-2012 is to increase the intensity and depth of ICT use by students and civil society. More specific aims outlined as part of this goal include: ensuring that people will have connectivity and access to ICTs that will enable them to carry out their various activities; ensuring that the country has a range of services and public and private content available on the Net that are relevant and suited to the needs of the educational process; and ensuring that the country has a strong network of public libraries, service centres and other community access points to foster digital inclusion for low-income sectors. Furthermore, the strategy document



also states that the number of broadband connections throughout the country is expected to double. The Administration that took office in March 2010 has a digital agenda for addressing universal access and broadband issues. In July 2010, the Under Secretary for Telecommunications publicly expressed interest in coordinating multilateral efforts within the context of a work plan to lower the cost of international broadband connections in South America.

*Colombia.* ICT Act No. 1341 does not target broadband development specifically and mentions broadband only in paragraph 2 of article 69. The Ministry of Information Technology and Communications supports projects aimed at providing mass access to broadband in the first and second income tiers over TPBCL and TPBCLE networks through the Information Technology and Communications Fund.

*Costa Rica.* The policy guidelines of the National Plan for Telecommunications Development for 2009-2014 provide for: immediate actions to ensure broadband Internet access for all sectors of the population, starting with a 512 kbps minimum speed for populations living in economically and socially vulnerable areas, 4 Mbps for commercial services, and symmetric super-broadband (20 Mbps) and symmetric ultra-broadband (100 Mbps) for production sectors that require higher bandwidths. In addition, the Digital Agenda contained in the National Plan includes the specific objective of “guaranteeing coverage”, which is defined as increasing access to broadband Internet within the proposed transmission speed ranges during the first year of the plan’s implementation.

*Cuba.* The analysis initiated by the local telecommunications company (Empresa de Telecomunicaciones de Cuba S.A. - ETECSA) in terms of the development goals for the new concession period include the development of broadband in the country.

*Ecuador.* The country has a plan to implement access and universal service in rural and marginalized urban areas over a five-year period. The plan’s objectives include increased connectivity and the promotion of widespread use of the Internet.

*El Salvador.* Broadband promotion does not figure as a component of national policy. The only related item is that the country supports the construction of the Mesoamerican Information Highway (AMI). The development of this major fibre optic network in order to interconnect the region while reserving capacity for the promotion of government social projects, is to be coordinated as part of the Mesoamerican Agenda for the Integration of Telecommunications Services.

*Guatemala.* There is no formal plan for the development of broadband, but sub-component 1.4 of the Rural Economic Development Programme (PDER) being funded by World Bank loan 7374-GU sets out the following specific targets for the telecommunications sector: (a) 100% of the municipalities in the eight departments falling within the Programme's target area are to have access to broadband Internet; (b) 100% of the rural communities with populations of over 400 people are to have access to a phone within 5 kilometres of their place of residence; and (c) 90% of the demand for skills training for Internet use is to be satisfied.

*Mexico.* The stated objective of the country's connectivity agenda is to ensure universal broadband access throughout the country on the government and community levels, especially in schools and educational institutions, libraries, health-care centres, government offices at all three levels of government, and through the network of community access points located in high-poverty areas and geographically remote locations.

*Nicaragua.* As part of an initiative funded by a World Bank loan, projects are to be launched to set up Internet access points and Internet centres in every municipality throughout the country that does not yet have broadband service.

*Panama.* Through its universal Internet access project (National Internet Network), the country has more than 651 free Internet WiFi hotspot access sites in 22 cities. This promotes equal opportunities for citizens and the expansion of operators' network platforms, leading to a sustained drop in broadband costs throughout the country. Act No. 59/2008 promotes the provision of public telephone service, Internet access and other services to meet the needs of people living in disadvantaged areas.

*Paraguay.* CONATEL is carrying out the "Paraguay Connected 2013" programme, whose objective is to implement telephony and Internet access in every municipality throughout the country.

*Peru.* FITEL focuses on Internet projects and broadband access in rural areas. In addition, as of the time of writing, a broadband development plan was being designed. To date, the commission entrusted with drawing up this plan has produced two reports: an analysis of the broadband market and a study of the obstacles to its development.

*Trinidad and Tobago.* In addition to its broadband development plan, the country is studying and designing the Fastforward.tt Agenda, which focuses on the adoption and use of ICTs by the public and by businesses. As of the

time of writing, strategic outcomes, attributes and initiatives related to the development of broadband and universal access were being analysed.

*Uruguay.* The country does not have a broadband development plan. However, the Ceibal Plan includes relevant policy guidelines in relation to the broadband connectivity. While the Ceibal Plan did not originally include connectivity goals, in 2010 broadband connectivity objectives were incorporated into the project's design.

*Bolivarian Republic of Venezuela.* While the country has no legal instrument or specific plan for broadband development or access, widespread Internet access is guaranteed by Presidential Decree No. 825 of 2000, which declares that Internet access and use is a policy priority for the cultural, economic, social and political development of the country.

## Bibliography

- Alleman, James; Rappoport, Paul and Aniruddha Banerjee (2010). Universal Service: A new definition? *Telecommunications Policy* Vol. 34, 1-2. pages 86-91.
- Atkinson, Robert; Correa, Daniel and Julie Hedlund (2008). *Explaining International Broadband Leadership*, Special Report on Policy Issues. The Information Technology and Innovation Foundation. <http://archive.itif.org/index.php?id=142>. (17/08/10).
- World Bank (2009). *Information and Communications for Development 2009: Extending Reach and Increasing Impact*, Washington: The World Bank.
- Barrantes, Roxana (2008). Fondos especiales: la manera económica de hacer política redistributiva en el Perú, Lima: IEP.
- Cave, Martin; Sumit Majumdar e Ingo Vogelsang (2002). *Handbook of Telecommunications Economics*, Volume I, North Holland, Amsterdam.
- Comisión multisectorial temporal encargada de elaborar el "Plan Nacional para el Desarrollo de la Banda Ancha en el Perú" (2010).
- \_\_\_\_ Report Number 03: Visión, metas y propuestas de política para el desarrollo de la banda ancha en el Perú. [http://www.mtc.gob.pe/portal/proyecto\\_banda\\_ancha INFORME\\_03\\_BANDA\\_ANCHA\\_.pdf](http://www.mtc.gob.pe/portal/proyecto_banda_ancha INFORME_03_BANDA_ANCHA_.pdf). (10/09/10).
- \_\_\_\_ Working paper Number 02: Barreras que limitan el desarrollo de la banda ancha en el Perú. Perú. <http://www>.
- \_\_\_\_ Working paper Number 01: Diagnóstico preliminar sobre el desarrollo de la banda ancha en el Perú. [http://www.ongei.gob.pe/pdf/banda\\_ancha.pdf](http://www.ongei.gob.pe/pdf/banda_ancha.pdf). (10/09/10).
- FCC (2010). *Connecting America: National Broadband Plan*. <http://www.broadband.gov/download-plan/> (10/09/10).
- ITU and INFOdev (2009). Universal Access and Service (UAS) Module 4. ICT Regulation Toolkit. [www.ictregulationtoolkit.org/en/Section.3126.html](http://www.ictregulationtoolkit.org/en/Section.3126.html) (15/08/10).
- ITU (2006). *What rules for universal service in an IP-enabled NGN environment?* Background paper. <http://www.itu.int/osg/spu/ngn/documents/Papers/Xavier-060323-Fin-v1.pdf>. (25/08/10).

- \_\_\_\_\_. (2004). ITU and its Activities Related to Internet-Protocol (IP) Networks, Version 1.1, Geneva, Chapter 7, [http://www.itu.int/osg/spu/ip/chapter\\_seven.html](http://www.itu.int/osg/spu/ip/chapter_seven.html). (10/07/10).
- Katz, Raúl (2010), *The impact of broadband policy on the economy*, 4th ACORN-REDECOM Conference Brasilia May 14-15, 2010. [www.acorn-redecom.org/papers/acornredecom2010katz.pdf](http://www.acorn-redecom.org/papers/acornredecom2010katz.pdf). (05/08/10).
- \_\_\_\_\_. (2009). El papel de las TIC en el Desarrollo. Colección Fundación Telefónica, Madrid: Ariel.
- Levin, Stanford (2010). Universal Service and targeted support in a competitive telecommunications environment. *Telecommunications Policy* Vol. 34, 1-2. pages 92-97.
- Majumdar, Sumit; Ingo Vogelsang and Martin Cave (2005), *Handbook of Telecommunications Economics*, Volume II, North Holland, Amsterdam.
- Milne, Claire (2006). *Telecoms demand: measures for improving affordability in developing countries. A toolkit for action*. Main Report. January 2006. Department of Media and Communications (MEDIA@LSE). <http://www.lse.ac.uk/collections/media@lse/pdf/affordability%20report%2031.01.06.PDF>. (06/08/10).
- Navas-Sabater, Juan; Andrew Dymond, A., and Niina JUNTUNEN (2002). *Telecommunications and information services for the poor*. World Bank Discussion Paper No. 432. Washington, DC: The World Bank.
- OECD (2009). *Guide to measuring the Information Society*. <http://www.OECD.org/dataOCDE/25/52/43281062.pdf>.
- \_\_\_\_\_. (2008). *Broadband Growth and Policies in OECD countries*. [www.OECD.org/dataOCDE/32/58/40629032.pdf](http://www.OECD.org/dataOCDE/32/58/40629032.pdf). (15/09/10).
- \_\_\_\_\_. (2006). *Rethinking Universal Service for a Next Generation Network Environment*. Working Party on Telecommunication and Information Services Policies.
- OFCOM (2010). *Super-fast broadband*. Context and summary for Ofcom's consultations on the wholesale local access and wholesale broadband access markets.<http://stakeholders.ofcom.org.uk/binaries/consultations/wba/annexes/context.pdf>. (12/09/10)
- \_\_\_\_\_. (2009). *Delivering super-fast broadband in the UK. Promoting investment and competition*. [http://www.ofcom.org.uk/consult/condocs/nga\\_future\\_broadband/statement.pdf](http://www.ofcom.org.uk/consult/condocs/nga_future_broadband/statement.pdf). (02/07/10)
- REGULATEL (2006). *Nuevos Modelos para el Acceso Universal de los Servicios de Telecomunicaciones en América Latina*, by Peter Stern and David Townsend.[www.regulatel.org/publica/estudio\\_su.htm](http://www.regulatel.org/publica/estudio_su.htm)
- Riordan, Michael H. (2002). *Universal Residential Telephone Service*, en Cave, Majumdar and Vogelsang (2002), chapter 10, pages 423-473.
- Sturzenegger, Federico and Mariano Tommasi (1998). *The political economy of economic reforms*. Boston: MIT Press.
- Wellenius, Björn and David N. Townsend (2005). *Telecommunications and Economic Development*, en Majumdar, Vogelsang and Cave (2005), Chapter 14, pages 555-619.

## **VIII. Broadband policies in Latin America and the Caribbean**

Hernán Galperin and Fernando Rojas

Knowledge and information are key assets for achieving economic prosperity and social well-being. Ensuring that households and businesses have access to the networks that transport these assets is a pressing task for Latin America and the Caribbean. Broadband Internet is the foremost of these networks and is playing an increasingly important role in the generation and distribution of information and knowledge. The studies compiled in this book demonstrate the importance of broadband access as a platform for economic growth, job creation, integration into innovation networks and access to new markets and as a tool for boosting the efficiency and expanding the scope of the provision of public goods.

As a general-purpose technology, broadband cuts across markets and activities. The development of complementary assets, or complementarities, is therefore a key requirement for expanding the benefits of ICTs. When coordination failures occur, it falls to the State to bring together the different economic and social actors in order to create complementarities and trigger ICT spillover effects throughout the economy. When it fulfils this role, public policy also promotes sector and systemic convergence, with this being understood as the ability to create new ICT synergies with other technologies and national innovation systems. Given that broadband investments have a greater impact when they are accompanied by improvements in the provision of other factors, such as human capital, it is the State's responsibility to promote the balanced growth of production factors in order to maximize the benefits for society.

The effort made here to assess the economic and social impact of broadband is subject to various constraints. On the one hand, broadband and its use are an evolving phenomenon whose long-term effects are still difficult to identify. On the other, data availability is limited, particularly for the Latin American and Caribbean countries. Nevertheless, although the debate continues, the evidence suggests that the development of broadband generates direct and indirect positive effects across economic sectors, promoting growth and social welfare (see chapters I and II, in particular).

The evidence regarding the delay in the development of infrastructure and broadband adoption throughout Latin America and the Caribbean is conclusive, however. A comparison with more developed nations points up the region's shortfalls in terms of the adoption of services (chapter III), the deployment of high-capacity transmission networks (chapter IV), affordable access to quality services (chapter V) and policies for expanding access to include poor regions and remote populations (chapter VII). Only the considerable progress made in the deployment of mobile broadband networks and services stand out as an accomplishment (chapter VI). While the data reflect very different degrees of progress from one country in the region to the next, even the best-performing countries are turning in results that are below expectations, as revealed by the broadband performance index presented in chapter V.

In summary, despite the progress made in the deployment of telecommunications infrastructure and the adoption of ICT services over the past 20 years, the region faces major challenges ahead if it is to capture the economic and social development benefits that broadband is capable of delivering. Against this backdrop, a range of options are available for government action. The objective of this chapter is to provide an overview of the tools available to policymakers linking them to the hypotheses and evidence presented throughout this study in order to provide guidelines for governments in designing strategies to maximize the positive impact of broadband.

Table VIII.1 presents the different policy areas for the development of the broadband system in which government action is required. Because the objectives in each of these areas cannot be achieved solely through mechanisms of market coordination, the State has an important role to play, either through regulatory action aimed at guiding the private sector's behaviour or, in some instances, through direct provision.

Table VIII.1

**The role of the state in the development of broadband systems**

Areas	Objectives	Tools
Systemic complementarities	Correct intersectoral coordination failures and promote the development of synergies.	National broadband strategy. Demand incentives and build-up of absorption capacity. Promotion of e-government services and local content.
Universal access and use	Universalization of access and use to take advantage of positive externalities, including network effects.	Public investment in backbone networks. Redesign and use of resources assigned to universal service funds. Credit lines for equipment and public access programmes.
Government resource management	Allocation and efficient management of such resources as spectrum, easements and domain names.	Release and flexible use of spectrum. Coordination with other State infrastructure programmes. Facilitation of access to poles, ducts and rights-of-way.
Legislation and regulation	Modernization and adaptation of the policy/regulatory environment to promote technological convergence.	Streamline and simplify licensing (single licence). Technological neutrality. Infrastructure sharing. Definition of IP interconnection regime.
Diffusion of technological innovation	Accelerating the learning process, increasing capacity for innovation and diffusion of best technological practices.	Digital literacy programmes and human capital formation. Support for adoption and training in microenterprises and small businesses. Promotion of ICT academia-industry links.
Public policy	Adapting the focus of public policy to address a highly dynamic, evolving and innovative environment.	Regional policy coordination and standardization. Mechanisms to monitor results. Reducing the tax burden on the telecommunications sector.

Fuente: Valeria Jordán, Wilson Peres y Fernando Rojas, *Banda ancha: una urgencia para América Latina y el Caribe*, CEPAL, 2010.

Two premises underlie the policy recommendations presented below. The first is that, given the available evidence about the positive impact of broadband and in view of the delay in deployment and adoption in the countries of the region, policies need to be formulated immediately to address these challenges. Otherwise, the benefits of broadband will be largely captured by other countries or regions, or will be confined to small clusters of innovation within the better-positioned countries in the region. The second is that, given the multiple demands on the public resources of governments in the region, policies to promote broadband must consider the role of the private sector in infrastructure and service deployment; the government's role should be to guide investments, correct coordination failures and carry out complementary public investment to maximize positive externalities and ensure compliance with social equity objectives.

## A. Develop and implement national broadband plans

Broadband is an example of a technological system of complementary goods and services that requires coordination mechanisms to guide the long-term investments of the wide range of private actors involved in the provision and consumption of those goods and services. Without these mechanisms, the development of the system would be delayed, while direct

benefits and spillovers to the rest of society would also be limited. Therefore, in addition to promoting and regulating private economic activity, it is the State's role to formulate a strategic vision focused on the importance of broadband development in order to reduce uncertainty for private investment and coordinate the efforts of the various public-sector entities and civil society organizations.

As seen in chapter VII, many OECD countries already have national broadband plans, several of which have been formulated as a component of the economic stimulus packages devised in the wake of the international crisis that broke out in late 2008 (Qiang, 2010). In Latin America and the Caribbean, the number of initiatives to encourage the development of broadband have grown by leaps and bounds in recent years. However, at least three major flaws can be observed. In some cases, these initiatives do not provide for the proactive role that the State must play in developing the basic infrastructure that supports the rest of the system. In others, the many private and public projects (at various administrative levels of government) lack a long-term strategic vision, which weakens coordination and interferes with a correct allocation of resources. Finally, there are cases in which ambitious plans are being formulated (typically called "digital agendas") that lack effective mechanisms for implementation and the necessary resource commitments.

A review of international experiences makes it possible to identify the requirements that national broadband plans need to meet. First, plans must be credible for all stakeholders, which implies that they must be formulated at the highest political level and be accompanied by implementation mechanisms and medium-term funding commitments. Second, they should include mechanisms for ongoing consultations with a wide range of actors from the private sector (especially those involved in providing infrastructure and services), civil society (in particular, the education sector) and different government jurisdictions and agencies. These consultations should be aimed at building consensus on priority actions and avoiding a duplication of efforts. Third, targets must be ambitious, but realistic, and must be coupled with explicit resource commitments and mechanisms for monitoring compliance. Fourth, the responsibilities of the executing agency must be clearly defined. Its composition should reflect the horizontal impact of broadband in various areas of economic activity and government. Finally, the possibility of applying the same type of regulatory system to broadband Internet access as is used for other public services should be evaluated, as this approach would give the State a more active role in mobilizing public resources, regulating private-sector activity and implementing universalization policies.



Current economic conditions in most of the countries in the region provide an opportunity for governments to formulate national strategies for broadband development. Internationally, there is consensus regarding the need for proactive public policy (Kelly et al., 2009), and the initiatives under way in other regions offer valuable lessons about what the best policy tools are for achieving the desired objectives. Moreover, in many countries of the region, governments have now regained the ability to implement public policies within the context of a newly achieved balance between private enterprise and State action. Furthermore, a reasonably favourable macroeconomic situation, coupled with fiscal stability, opens the way for committing public resources to initiatives and strategies to boost private investment and accelerate the development of the broadband system. In sum, a favourable economic and policy environment exists for the formulation and implementation of national broadband plans.

## **B. Develop a favourable regulatory environment**

Despite the great strides made over the last two decades, a deficit in telecommunications infrastructure persists in Latin America and the Caribbean. This study has shown that the consequences of this deficit include markets that are operating below their potential and persistent inequalities in service access which limit the positive externalities of broadband production and consumption. It has also shown that some indicators suggest that the gap in infrastructure (particularly next-generation networks) and services between countries in the region and the more developed nations is widening.

A suitable regulatory environment is one of the main prerequisites for market development, the attraction of investment and the adoption of new technologies, particularly given the increasing technological convergence associated with broadband (Wohlers and García Murillo, 2009). This environment should not only facilitate private-sector activity, but should also guide investments towards priority segments and underserved geographic areas. On the other hand, a long-term balance needs to be struck between inter-platform competition and intra-platform competition in network segments where duplication is inefficient. Given the dynamics of the technologies associated with broadband, it is the State's responsibility to review and adjust the regulatory and legal framework for technological developments on an ongoing basis, while also preserving legal certainty and the acquired rights of the players involved.

More specifically, a favourable regulatory environment for private investment in basic infrastructure is one that:

- *Offers transparent regulatory processes and mechanisms for designing policies that provide for various levels of consultation with the private sector.* While the region has progressed over the last 15 years in this respect, the institutionalization of processes and the empowerment of local and regulatory agencies remain ongoing challenges.
- *Provides effective mechanisms for resolving interconnection conflicts between private enterprises.* In particular, the migration to IP networks presents an opportunity to reformulate the guidelines for interconnection between networks to ensure system integration and strengthen competition among operators.
- *Defines efficient, transparent licensing mechanisms.* There is consensus as to the need to move towards single licences (already in place in Argentina, Guatemala and Peru) in order to give providers the flexibility they need to offer multiple services using a combination of technologies (Marshall et al., 2009).
- *Facilitates access to rights-of-way, poles, ducts and other assets necessary for the deployment of telecommunications infrastructure.* In particular, it is recommended that a gradual transition be made to national regimes which help to limit the fragmentation of those rights into multiple jurisdictions in order to speed up the deployment of networks and limit discretion in granting access.
- *Promotes infrastructure sharing.* By significantly cutting deployment costs, sharing passive elements of next-generation networks (pipelines, towers, etc.) reduces entry barriers for new competitors and facilitates the coordination of investments for the deployment of services in areas of low profitability (ITU, 2008). The process is more complex from a regulatory standpoint for the active elements of the network (base stations, optical fibre networks, etc.). Several countries' experiences have proven, however, that infrastructure sharing is necessary in order to tip the balance and convince private consortia to undertake long-term investments (including submarine cables and high-capacity trunk networks).
- *Promotes traffic exchange points at a national level as well as the proximity of content to users.* The increase in peer-to-peer traffic and the growth of local content supply underscore the need to promote mechanisms for exchanging IP traffic locally (Echeberría, 2010). To attract providers

and content distribution networks, a favourable regulatory environment is needed to protect privacy and copyrights, ensure legal responsibility for content and guide other factors affecting investment decisions.

- *Defines the regulatory approach to network neutrality.* The advances in high-capacity IP networks and the new business models associated with them have placed the debate regarding net neutrality at the centre of the Internet policy debate. A neutral network is free of restrictions in terms of the type of equipment that can be used to connect to it and ensures non-discriminatory access for users to services and content. Regulators have an important role to play in striking an appropriate balance between promoting innovation and private investment in next-generation networks, on the one hand, and preventing anti-competitive practices and ensuring pluralism in content and services, on the other.

### **C. Carry out public investment in basic infrastructure**

There are several reasons why private investment in telecommunications infrastructure is insufficient, in and of itself, to maximize the benefits of broadband systems. The evidence points to three main factors: the existence of non-linear benefits requiring that certain adoption thresholds be reached in order to maximize the impact of broadband (Koutroumpis, 2009); externalities in broadband consumption and production that cannot be captured by the operators directly involved, which leads to investment volumes that are below socially efficient levels (Rosston et al, 2010); and problems in identifying and aggregating demand in marginal areas that delay the deployment of high-capacity networks and undermine social inclusion goals (Berkman Center, 2010).

The general consensus points to the need for public investment in basic telecommunications infrastructure that focuses on the following objectives:

- *Complementing private-sector investment.* Public investment in interurban backbone networks to transport data under an open and non-discriminatory access model can encourage private investment in the last-mile segment (Kim et al., 2010). In particular, the deployment of fibre backbones must be provided for in national and regional infrastructure plans.
- *Focusing on non-competitive segments and areas of low or null profitability for the private sector.* Public investment in alternative data transport networks

has proved to be a useful tool in dealing with bottlenecks in certain market segments (especially in backbone segments). On the other hand, public investment can serve as a tool to unlock investments and meet regional development objectives in poor or low-density areas, where difficulties in developing demand and capturing externalities result in private investment shortfalls (Qiang, 2010).

- *Network management based on the principles of open and non-discriminatory access.* These principles are particularly important when public investment is focused on promoting access in disadvantaged areas and increasing competition among data transport networks. This model facilitates the mobilization of private investment in the last mile and minimizes price distortions. In particular, the infrastructure requirements for interurban data transport and --so long as the number of broadband clients continues to grow-- network usage will continue to increase, resulting in congestion and a degradation of quality of service.

A review of regional and international experiences reveals a number of different models for financing public investment in basic infrastructure. To date, direct public investment in backbone networks has generally been the most prevalent approach, with such investments being financed either by national government resources or, in some cases, local governments. There have been very few regional experiences in public-private co-financing, despite evidence that this has yielded positive results for the financing of high-capacity data networks in other regions.<sup>1</sup>

Funding sources must be evaluated carefully, since any publicly funded investment in telecommunications competes with multiple demands from other areas served by the State. Various funding strategies aimed at minimizing the impact on the public treasury can be identified:

- *The mobilization of under-utilized public assets.* The use of fibre optic networks that have already been deployed at the State level is of particular importance, as shown by recent initiatives in Brazil and Mexico that take advantage of existing fibre networks to control the power grid.<sup>2</sup> The mobilization of existing assets reduces investment requirements and makes it possible to use technologies that increase the transmission capacity of broadband systems without deploying new physical networks.

---

<sup>1</sup> See the discussion of experiences in Nordic countries and East Asia in Kim et al. (2010).

<sup>2</sup> For a discussion regarding the Mexican experience, see Flores-Roux and Mariscal (2010).

- *Leverage the public sector's connectivity demands.* The government is the largest connectivity client in any country, given its need to connect government offices, libraries, universities, hospitals and schools throughout the country. In some cases, public infrastructure development is a necessity in areas that fail to attract private investment. Public investment in access networks can reduce future connectivity costs and maximize spillovers to the extent that these networks can also be used by households and businesses.
- *Use of universal service funds (USF).* Established during the initial period of sector reform during the 1990s, these funds have several shortcomings in terms of their ability to identify demand priorities, disburse funds and adapt to technological change. Shifting these resources towards investments in fibre optic backbones would speed up deployment and reduce the multiple risk factors associated with connectivity initiatives in the last mile. By extending backbone networks to provincial capitals, townships or municipalities, these investments can meet the government's connectivity needs while promoting a qualitative leap forward in the availability of infrastructure in areas considered unattractive by the private sector. Financing for small, local operators in the last-mile segment would be a complementary tool to accelerate resource utilization, share risks with private actors and optimize the use of resources based on the diversity of the connectivity demands in each area (Galperin and Bar, 2007). Internationally, there is also a tendency to broaden the funding base for USFs in order to improve the distribution of the costs and benefits of broadband development.<sup>3</sup>
- *Tax cuts for components of the broadband system.* In general, the countries in the region tax goods and services associated with broadband quite heavily, with their fiscal policies providing for a combination of direct taxes on services, general consumption taxes and import taxes on specific types of equipment (Galperin and Katz, 2009, and Katz et al., 2010). The evidence presented in this study about the high elasticity of broadband prices and spillover effects on economic activities suggest that these tax policies should be reviewed, especially in light of the fact that most of the national broadband plans implemented to date include significant reductions in the sector's tax burden.

---

<sup>3</sup> For example, one of the objectives of the national broadband plan in the United States is to increase the sources of financing for universal service. Meanwhile, Canada uses a fiscal mechanism, providing operators with a tax break for a wide range of telecommunications and other related services. This mechanism is considered to be more sustainable in the long term because it introduces fewer price distortions.

In summary, there are numerous different ways to step up public investment in basic telecommunications infrastructure, and many of them do not entail increases in direct public spending but rather enhance the mobilization of existing resources. Furthermore, they take advantage of the government's own connectivity needs and a redesign of current fiscal policies for the sector in order to strike a more efficient balance between present income and future well-being.

#### **D. Create incentives for demand and promote skills**

Progress in the development of broadband systems is driven by the deployment of infrastructure and services as well as by demand for the content and applications associated with broadband. Therefore, policies to stimulate demand and human capital formation are essential to ensure positive spillovers and to generate the complementarities that broadband development requires. Furthermore, in order to reduce the productivity gap between Latin America and the Caribbean and the more developed economies, the generation of technology absorption capacities across industries is a key lever for increased efficiency and long-term growth. From this perspective, technological absorption is closely tied to the development of infrastructure and the necessary institutional framework in the areas of education, science and technology.

The wide range of policy tools available for the promotion of the development of absorption capacities and human skills in broadband-related products and services by businesses, households and the public sector include:

- *Incentives for the use of e-government services by individuals and businesses.* There is ample evidence that the State can serve as a catalyst for broadband demand by stimulating the use of e-government services, in addition to increasing its own administrative efficiency. Experiences in the field of taxes, government procurement and pension systems are particularly relevant for countries in the region, many of which have made significant progress in these areas.
- *Stimulus packages for the purchase of equipment and terminals, particularly personal computers.* The development of broadband systems requires additional investments by users, among which the acquisition of terminals is a major component. The evidence presented in this study reveals a particularly striking deficit in the region in terms

of personal computer penetration. This calls for proactive policies to boost the acquisition and modernization of equipment in homes and businesses (in particular among small businesses and microenterprises). Several countries in the region have implemented initiatives in this area, particularly tax incentives and the provision of credit for the purchase of personal computers (Laplane et al., 2007). These efforts must be stepped up while balancing the promotion of local electronics manufacturing with prices reductions and the expansion of the installed base of terminals. In order to accelerate the rate of modernization and equipment penetration, governments should evaluate the possibility of amending tax laws to allow more rapid asset depreciation.

- *Human capital formation.* Aside from existing supply gaps in access to broadband services, the evidence also points to the existence of a demand gap among households and businesses, which, despite having the necessary resources and potential access to services, do not become effective users. Digital literacy programmes, workforce training and initiatives to promote technical careers are needed to bridge this gap and develop the necessary human capital to take advantage of the systemic benefits associated with broadband. Countries in the region have implemented many initiatives in this area and are thus in a position to share successful experiences and develop joint efforts at the regional level.
- *The promotion of closer links between research universities and the ICT industry.* Despite progress in strengthening national systems for science and innovation in Latin America and the Caribbean, linkages between academic research institutions and hardware and software industries in the region are still limited (Cimoli et al., 2005). The formulation of national broadband plans provides an opportunity to help strengthen these linkages through, inter alia, the establishment of ICT research centres with a mix of public-private financing; the participation of universities in deployment plans for networks and services; and the strengthening of high-speed academic networks. Furthermore, the greater the influence of technology-intensive sectors on the production structure, the faster the relevant learning processes will be, and this, in turn, will help to raise the rate of innovation and boost domestic and international demand (ECLAC, 2007).
- *The development of appropriate content and applications.* Part of the explanation for the gap in broadband demand lies in the lack of content

and services suited to the requirements of households and production units in disadvantaged areas. Aside from changes in consumer habits that have helped to increase local content traffic, there are a number of opportunities for developing policies for fostering the generation of local content and applications. For example, there have been successful public initiatives to stimulate the production of content in indigenous languages and rural information systems. These initiatives can play an important role in revealing and activating demand for broadband in areas of little interest to existing operators.

- *A safe and enabling regulatory environment for e-transactions.* Just as with transactions in the real economy, the development of electronic transaction services requires a legal environment that provides protection to the participating parties (Gamba, 2010). Strengthening consumer rights with respect to broadband quality of service and lock-in by service operators stand out in this respect. At the same time, further regulatory work is necessary in the areas of privacy, data protection, e-transactions, as well as with regard to the rest of the rules that enable and encourage the adoption of broadband in the economy and society at large.
- *Support for public access venues.* Despite the sustained growth in the number of individual subscribers, the evidence presented in this study indicates that shared broadband access will continue to play a significant role in the region over the medium term. In this regard, complementarity between public and private actors is of key importance. Public access venues can promote skills, encourage the adoption of e-government services and foster local content creation. Experiences in various parts of the region illustrate the potential of such initiatives for fostering broadband demand and the acquisition of technology-related skills, all of which has a positive effect on employability and school performance (Rojas Mejía, 2010).
- *A public policy focus on microenterprises and small businesses.* The evidence presented in chapter III regarding the importance of microenterprises and small businesses in the region's economy, particularly with respect to job creation, indicates that the impact of broadband access in the workplace is comparable to that of public access centres. It follows that programmes which provide financing and tax breaks for the purchase of equipment, together with technology skills training and e-procurement, should be specifically targeted at microenterprises and small businesses. In most countries in the region, the government already has programmes



in place to promote small businesses and microenterprises, and these initiatives can be leveraged into other types of actions in order to boost their full integration into broadband systems.

## **E. Increase the availability of radio spectrum**

The evidence presented in chapter VI attests to the central role of wireless services in the expansion of broadband Internet access in the region. The ability to provide wireless broadband services largely depends on the availability of radio spectrum, since access to this resource determines the costs of deploying infrastructure as well as the competitive market structure. Increasing the availability of radio spectrum is therefore an essential component in the development of broadband in the region.

The advantages of wireless broadband have been documented extensively in this study. They include lower costs and faster network deployment, the scalability and adaptability of infrastructure investments and the opportunity to build upon the massive deployment of second-generation mobile networks and terminals in the region. Today, network deployment and the quality of wireless broadband services are constrained by the limited supply of radio spectrum available to current and potential operators. The evidence further suggests that this shortage is, for the most part, artificial, since many spectrum bands used by operators in other regions of the world are not in use or are greatly underutilized in Latin America and the Caribbean.

In recent years, governments in the region have started to tackle this problem, and this has resulted in a steady increase in the availability of radio spectrum for wireless services. However, international comparisons, such as those presented in chapter V, continue to cast the region in an unfavourable light, which points up the need to accelerate the release of spectrum and redefine allocation mechanisms to improve its utilization. In this respect, the following guiding principles for spectrum management can be set forth:

- *Balance fiscal contributions and the maximization of social value.* Countries in Latin America and the Caribbean have followed the international trend towards the allocation of radio frequencies through auctions and the usage fees charged to operators. Although this mechanism has advantages over administrative allocation by tender (i.e., a beauty contest), it, in and of itself, does not ensure the maximization of social value in resource utilization (Avanzini and Muñoz, 2010). There are several reasons for this, including the uncertainty of demand for new services (which has been

overvalued in the auctions for 3G mobile services), the need to mitigate anti-competitive behaviour and allow the entry of new operators, and the need to achieve public safety and universal service goals. Therefore, bidding mechanisms must take into account fiscal policy objectives in the short term, while balancing an efficient allocation of resources with social equity goals in the long term.

- *Relax licensing restrictions on the use of radio spectrum.* Rapid changes in wireless technologies and consumer behaviour hinder the efficient allocation of radio spectrum through *ex ante* mechanisms. This is the underlying reason for the current international trend towards the gradual relaxation of the technical and service requirements associated with radio spectrum licenses, in addition to a growing availability of spectrum for unlicensed use (Hazlett and Muñoz, 2009). The delay in the issuance of new bands in the region presents an opportunity for governments to ease the technical and service requirements for future licences, which will allow them to set up more efficient mechanisms for resource allocation and for the promotion of innovation in wireless technologies and services.
- *Speed up the transition to digital television in order to take advantage of the "digital dividend".* The digitization of terrestrial television service offers a unique opportunity for the reallocation of radio spectrum in the UHF band. Propagation characteristics in this band make it particularly attractive for extending the coverage of wireless broadband services in areas with low population density (AEGIS, 2010).<sup>4</sup> This is an especially promising opportunity for countries in the region, since, in most cases, very few services are currently deployed in the upper UHF band. Governments in the region are therefore well-positioned to promote the modernization of the terrestrial television system and, at the same time, increase the reach of wireless broadband deployment.

## F. Promote regional coordination

In order for the set of public policy tools discussed above to be effective, regional coordination mechanisms must be put in place in order to maximize

---

<sup>4</sup> Avanzini and Muñoz (2010) estimate that the reallocation of 108 MHz in the upper portion of the UHF band (typically referred to as the "digital dividend") to mobile telephony services would result in a social surplus of approximately US\$ 408 per capita in Latin America.

the impact of national initiatives and to take advantage of growing regional interdependencies in regard to infrastructure, services and content. These types of measures that are required in this area include:

- *Setting up mechanisms for exchanging information on successful initiatives and best practices throughout the region.* As discussed in this study, many initiatives have been launched to extend broadband services by governments in Latin America and the Caribbean. The establishment of mechanisms for exchanging information about outcomes and success factors would provide a valuable learning tool for use in the development of future initiatives. The experience gained in the process of setting up mechanisms for information exchange within the framework of the eLAC2010 and eLAC2007 regional action plans is particularly instructive.
- *Developing indicators for monitoring infrastructure deployment and broadband adoption.* The quality of any public policy largely depends on the availability of the information needed for monitoring and targeting policy initiatives. In this sense, the lack of harmonized broadband data (both in terms of supply and demand) represents a challenge for the region's policymakers. It also constrains efforts to evaluate policy impacts and to monitor progress in the international context. In this regard, noteworthy progress has been made by the Observatory for the Information Society in Latin America and the Caribbean (OSILAC) in promoting the adoption and systematization of statistics on broadband use in households, businesses, schools and government offices. These types of experiences must be built upon in order to generate more and better tools for making use of the various policy options (OSILAC, 2010).
- *Promoting the harmonization of technical requirements and the allocation of radio spectrum.* In order to achieve economies of scale, increase investment by transnational corporations and lower the equipment costs associated with broadband, regional harmonization in terms of technical requirements and equipment certification is required. This type of harmonization is particularly important for the allocation of radio spectrum for wireless broadband services, which would greatly benefit from economies of scale in terminal equipment. Governments in the region are already working on several harmonization initiatives under the auspices of the Inter-American Telecommunications Commission (CITEL), while operators with a regional presence are working within the framework of organizations such as the Hispanic-American Association of Research Centres, and Telecommunications Enterprises (AHCJET) and GSMA. These types of coordination

mechanisms play an important role in the attainment of economies of scale and the expansion of the licensing of spectrum required in order to permit greater mobile broadband deployment.

- *Promoting the use of exchange points for regional IP traffic.* In many countries, the cost of international links continues to act as a barrier to the deployment of more affordable and better-quality broadband services. Like national exchange points, regional IP exchange points can reduce these costs and improve service quality for all users (Echeberría, 2010). Steps taken in this direction should be coupled with incentives for hosting content in the region in order to further reduce dependence on international links.

Finally, as stated in Jordán, Peres and Rojas (2010), taking action on all of these fronts will require strengthening the entities responsible for formulating and implementing broadband policies and ensuring close coordination and complementarity between the State and private and social actors. In addition, the proposals must be underpinned by allocating the human resources and equipment needed to close the gap for each country or region within that country. To meet the commitment to closing gaps, these policies need to be pursued at the highest levels of government having the authority to pledge financial resources and political will. Building a consensus within society is essential for the effective dissemination and use of such a broad-reaching technology. For the information society to become a reality, universal access to broadband must be ensured now for purposes of innovation, economic growth and social inclusion. The urgency and speed at which progress must be made will be determined by the size of the gap and, above all, by the fact that it is widening in the context of the current technological revolution.

## Bibliography

- AEGIS (2010), “Digital TV Spectrum Requirements: Status of Digital TV Spectrum in Latin America”, GSMA, Londres.
- Avanzini, Diego y Roberto Muñoz (2010), *El Valor Social de la Banda de 700MHz en América Latina*, DIRSI, Lima.
- CEPAL (2007), *Progreso técnico y cambio estructural*, División de Desarrollo Productivo y Empresarial, CEPAL, Santiago de Chile.
- Cimoli, Mario, Joao Carlos Ferraz y Annalisa Primi (2005), “Science and technology policy in open economies: the case of Latin America and the Caribbean”, Serie Desarrollo productivo, 165 (LC/L.2404), CEPAL, Santiago de Chile.

- David, Paul (1999), *Digital Technologies and the Productivity Paradox: After Ten Years, What Has Been Learned?*, Conferencia Understanding the Digital Economy: Data, Tools and Research, Washington, D.C., Mayo.
- Echeberría, Raúl (2010), *Desarrollo de infraestructura e interconexión regional*, Registro de Direcciones de Internet para América Latina y el Caribe (LACNIC), Montevideo.
- Flores-Roux, Ernesto y Judith Mariscal (2010). *Política de Generación de Infraestructura de Telecomunicaciones en México*, DIRSI, Lima.
- Galperin, Hernán y François Bar (2007), Diversifying Network Development through Microtelcos, *Information Technologies and International Development* 3(2): 73-86.
- Galperin, Hernán y Raúl Katz (2009), *Análisis del Impacto Económico y Social del Proyecto de Ley de Extensión de Impuestos Internos a Productos Tecnológicos y de Informática*, Documento de Trabajo No. 5, Centro de Tecnología y Sociedad. Universidad de San Andrés, Buenos Aires.
- Gamba, Jacopo (2010), *Panorama del derecho informático en América Latina y el Caribe*, División de Desarrollo Productivo y Empresarial, CEPAL, Santiago de Chile.
- Hazlett, Thomas y Roberto Muñoz (2009), “A Welfare Analysis of Spectrum Allocation Policies”, *RAND Journal on Economics*, 40: 424-54.
- Katz, Raúl, Ernesto Flores-Roux y Judith Mariscal (2010), *The Impact of Taxation on the Development of the Mobile Broadband Sector*. GSMA, Londres.
- Kelly, Tim, Victor Mulas, Siddhartha Raja, Christine Zhen-Wei Qiang y Mark Williams (2009), *What Role Should Governments Play in Broadband Development*, en infoDev/OECD Workshop on Policy Coherence in ICT for Development, París.
- Kim, Yongsoo, Tim Kelly y Siddhartha Raja (2010), *Building Broadband: Strategies and Policies for the Developing World*. Banco Mundial, Washington D.C.
- Koutroumpis, Pantelis (2009), “The Economic Impact of Broadband on Growth: A Simultaneous Approach”, *Telecommunications Policy* 33: 471-485.
- Laplane, Marcelo (2007), *Asimetrías de información en el mercado de computadoras personales: los casos de financiación de PC para consumidores de bajos ingresos*, documento no publicado, CEPAL, Santiago de Chile.
- Mariscal, Judith, Roxana Barrantes, Hernán Galperin y Christian Nicolai (2009), “Agendas Públicas e Instrumentos de la Regulación con Miras a la Convergencia”, en Márcio Wohlers y Martha García-Murillo (eds.). *Regulación y Estrategias Corporativas Frente a la Convergencia Tecnológica*, CEPAL, Santiago de Chile.
- OSILAC (2010), *Guías metodológicas para apoyar el cálculo y análisis de indicadores sobre el acceso y uso de las TIC*, CEPAL, Santiago de Chile.
- Qiang, Christine Zhen-Wei (2010), “Broadband Infrastructure Investment in Stimulus Packages: Relevance for Developing Countries”, *info*, 12(2): 41 – 56.
- Rojas Mejía, Fernando (2010), *Evolución de los Centros de Acceso Público a las TIC*, CEPAL, Santiago de Chile.
- Rosston, Gregory, Scott Savage y Donald Waldman (2010), *Household Demand for Broadband Internet Service*, informe a la Broadband.gov Task Force, Federal Communications Commission, Washington, D.C.
- UIT (2008), *Trends in Telecommunications Reform 2008: Six Degrees of Sharing*, UIT, Ginebra.
- Wohlers, Marcio y Martha García-Murillo (2009) (eds.), *Regulación y Estrategias Corporativas Frente a la Convergencia Tecnológica*, CEPAL, Santiago de Chile.

